

Government of Pakistan

**Accounting Policies  
and Procedures  
Manual**

## Table of Contents

<b>1</b>	<b>Introduction</b>	<b>1.1</b>
1.1	Purpose of the Manual	1.3
1.2	Structure of the Manual	1.4
1.3	Reader Guidance	1.5
1.4	Authority, Applicability, Distribution and Maintenance of the Manual	1.6
<b>2</b>	<b>Overview</b>	<b>2.1</b>
2.1	Introduction	2.3
2.2	Organisational Structure of the Accounting System	2.4
2.3	The Accounting System	2.8
2.4	Outline of Chapters	2.13
2.5	Abbreviations	2.15
2.6	Definitions	2.17
<b>3</b>	<b>Budgetary Control</b>	<b>3.1</b>
3.1	Introduction	3.3
3.2	General Policies	3.5
3.3	Detailed Procedures	3.8
3.4	Specific Budgetary Procedures	3.22
<b>4</b>	<b>Expenditures</b>	<b>4.1</b>
4.1	Introduction	4.5
4.2	General Policies	4.6
4.3	Accounting Policies	4.12
4.4	Accounting for Expenditures	4.16
4.5	Detailed Procedures	4.22
4.6	Salaries and Wages	4.36
4.7	Pension Payments	4.46
4.8	General Provident Fund	4.57
4.9	Contractor/Work Payments	4.64
4.10	Loans And Advances	4.72
4.11	Overseas Payments	4.79
4.12	Grants-in-aid, Contributions etc.	4.80
4.13	Assignment Account and Personal Ledger Account	4.82
4.14	Maintenance of Permanent Accounting Records	4.83
<b>5</b>	<b>Receipts</b>	<b>5.1</b>
5.1	Introduction	5.3
5.2	General Policies	5.4
5.3	Accounting Policies	5.7
5.4	Accounting for receipts	5.10
5.5	Detailed Procedures	5.12
5.6	Treatment of specific classes of receipt	5.20

<b>6</b>	<b>Bank Reconciliation</b>	<b>6.1</b>
6.1	Introduction	6.3
6.2	Overview	6.4
6.3	General Policies	6.5
6.4	Daily Procedures	6.9
6.5	Monthly Procedures	6.11
<b>7</b>	<b>Financial Reporting Procedures</b>	<b>7.1</b>
7.1	Introduction	7.3
7.2	General Policies	7.4
7.3	Year-end accounting policies	7.9
7.4	Detailed Procedure	7.11
<b>8</b>	<b>Loss and Recoveries of Public Money</b>	<b>8.1</b>
8.1	Introduction	8.3
8.2	General Policies	8.4
8.3	Accounting for Losses and Recoveries	8.7
<b>9</b>	<b>Self-accounting Entities</b>	<b>9.1</b>
9.1	Introduction	9.3
9.2	General Policies	9.6
9.3	Accounting Policies	9.7
9.4	Accounting for Self-accounting Entity Transactions	9.9
9.5	Detailed Procedures	9.10
<b>10</b>	<b>Project Accounting</b>	<b>10.1</b>
10.1	Introduction	10.3
10.2	General Policies	10.4
10.3	Accounting Policies	10.6
10.4	Accounting for Project Expenditures	10.8
<b>11</b>	<b>Accounting for Liabilities</b>	<b>11.1</b>
11.1	Introduction	11.3
11.2	General Policy	11.4
11.3	Categories of Liabilities	11.5
11.4	Accounting Policies	11.8
11.5	Accounting Procedures	11.10
11.6	Reconciliation of Liability Records	11.14
11.7	Reporting of Liabilities	11.15
<b>12</b>	<b>Transactions Between Government Entities</b>	<b>12.1</b>
12.1	Introduction	12.3
12.2	General Policies	12.5
12.3	Accounting Policies	12.10
12.4	Accounting for transactions between Government entities	12.13

12.5 Detailed Procedures

12.16

<b>13 Procurement and Asset Management</b>	<b>13.1</b>
13.1 Introduction	13.3
13.2 General Policies for Procurement	13.4
13.3 Accounting for Stores	13.5
13.4 Fixed Assets Management	13.8
13.5 General Policies for Disposal of Fixed Assets	13.11
13.6 Accounting for Proceeds from Disposals	13.13
<b>14 Public Account Transactions</b>	<b>14.1</b>
14.1 Introduction	14.3
14.2 General Policy	14.4
14.3 Accounting Policy	14.6
14.4 Detailed Procedures	14.9
14.3 Reconciliation of Public Account transactions	14.12
14.4 Reporting of Public Account balances	14.13
<b>15 Insurance</b>	<b>15.1</b>
15.1 Introduction	15.3
15.2 General Policies	15.4
15.3 Claims Against the Government	15.5
15.4 Accounting Policies	15.7
<b>16 General Accounting</b>	<b>16.1</b>
16.1 Introduction	16.3
16.2 Retention of Accounting Records	16.4
16.3 Maintenance of Accounting Records	16.6
16.4 Use of Suspense Account	16.8
16.5 Control of Official Forms and Chequebooks	16.9
<b>17 Assignment Accounts and Personal Ledger Accounts</b>	<b>17.1</b>
17.1 Introduction	17.3
17.2 Policies	17.4
17.3 Detailed Procedures	17.6
17.4 Appendix A - Assignment Account/Personal Ledger Account Transactions	17.12
<b>18 Forms</b>	<b>18.1</b>
18.1 Form layouts	18.1

# 1 Introduction

---

## Table of Contents

<b>1.1</b>	<b>Purpose of the Manual</b>	<b>1.3</b>
<b>1.2</b>	<b>Structure of the Manual</b>	<b>1.4</b>
<b>1.3</b>	<b>Reader Guidance</b>	<b>1.5</b>
<b>1.4</b>	<b>Authority, Applicability, Distribution and Maintenance of the Manual</b>	<b>1.6</b>
1.4.1	Authority	1.6
1.4.2	Effective date	1.6
1.4.3	Application	1.6
1.4.4	Compliance	1.7
1.4.5	Distribution, maintenance and update	1.7

**1.1 Purpose of the Manual**

1.1.1.1 The purpose of this Manual is to set out the detailed policies and procedures to be used in accounting for the Government of Pakistan's financial transactions.

1.1.1.2 Under Article 170 of the Constitution, the Auditor General can prescribe detailed policies and procedures in respect of the following:

- all transactions of centralised accounting entities
- specific transactions of self accounting entities which operate within overall control of the Auditor General e.g. staff related payments
- transactions adjustments of self accounting entities with the centralised accounting entities or in between themselves
- reporting requirements of the self accounting entities.

1.1.1.3 This Manual contains the detail to accompany the overall framework set out in the Manual of Accounting Principles (MAP).



**1.2 Structure of the Manual**

- 1.2.1.1 The Manual is structured according to the major financial management activities of the Government.
- 1.2.1.2 The organisation of the chapters and sections within the Manual is shown in the Table of Contents.
- 1.2.1.3 The first two chapters provide an introduction and an overview to the accounting system.
- 1.2.1.4 The following three chapters cover the core processes of budgetary control, expenditures and receipts.
- 1.2.1.5 Chapters 6 and 7 cover the supporting processes of bank reconciliation and financial reporting.
- 1.2.1.6 Subsequent chapters address the policies and procedures for supplementary processes and for other financial management activities of the Government.

### 1.3 Reader Guidance

1.3.1.1 There are five levels of heading in the Manual:

- level 1 - chapter
- level 2 - section
- level 3 - sub-section
- level 4 - direction
- level 5 - bullet point

1.3.1.2 The organisation of the sections and sub-sections within each chapter is shown in the Table of Contents at the front of each chapter.

1.3.1.3 The layout of each page within this Manual is standardised. The title of the Manual and the name of the chapter are displayed in the top left and right corners of each page respectively. The footer for each page contains the issue date, page number and file reference.

1.3.1.4 The general structure of each chapter within this Manual is standardised, dealing with the subject matter in the following sections (where this structure is inappropriate some chapters omit certain sections or are detailed in a different manner):

- introduction
- general policies
- accounting policies
- accounting treatment
- detailed procedures
- procedures for specific class of transactions.

1.3.1.5 A list of abbreviations and definitions of terms commonly used in this Manual is included for reference purposes.

1.3.1.6 The Appendix includes proformas of the registers and the forms to be used in the application of this Manual.

---

## 1.4 Authority, Applicability, Distribution and Maintenance of the Manual

### 1.4.1 Authority

1.4.1.1 This Manual is issued under the authority of the Auditor-General of Pakistan, in accordance with Article 170 of the Constitution of Pakistan, read with Pakistan (Audit and Accounts) Order 1973.

### 1.4.2 Effective date

1.4.2.1 The effective date for application of this Manual is the date of issue of the Manual by the Auditor-General.

1.4.2.2 All accounting entities will have up to two financial years (commencing from 1 July subsequent to the effective date of release) to be in full compliance with this Manual.

### 1.4.3 Application

1.4.3.1 **Accounting entities** - An accounting entity is any unit of the Government e.g. ministry, division and department, whose principal source of funding is an appropriation from the Government of Pakistan, and which is not an exempt entity (as listed in Schedule 2 of the MAP).

1.4.3.2 There are two types of accounting entity, namely centralised accounting entities and self accounting entities.

1.4.3.3 **Centralised accounting entities** - a centralised accounting entity is any accounting entity for whom the Accountant-General has primary responsibility for the transaction processing, recording and reporting functions of that entity. At no stage does this arrangement absolve the Principal Accounting Officer of his/her responsibilities for financial management, in accordance with Paragraph 8.1 of the MAP.

1.4.3.4 **Self-accounting entities** - a self-accounting entity is any accounting entity for whom the Principal Accounting Officer has primary responsibility for the accounting and reporting functions. A list of self-accounting entities is contained in Schedule 1 of the MAP (current at the date of issue of this Manual).

1.4.3.5 **Exempt entities** - an exempt entity is any entity listed in Schedule 2 of the MAP (current at the date of issue of this Manual). These include independent entities and commercial undertakings and entities established under a state resolution or a notification of the Government or under Companies Ordinance, but placed administratively under a

---

Ministry or Division for the purpose of accountability (also refer to Organisational Structure section of Chapter 2 ‘Overview’).

#### **1.4.4 Compliance**

- 1.4.4.1 Compliance with this Manual is mandatory for all centralised entities. Chapter 9 ‘Self-accounting entities’ sets out more detail on the applicability of this Manual to self-accounting entities.
- 1.4.4.2 Exempt entities are outside the scope of this Manual and are therefore not required to comply.
- 1.4.4.3 Compliance with the directives and principles contained in this Manual are mandatory as the principles and directives have been issued under the Pakistan (Audit and Accounts) Order 1973.
- 1.4.4.4 The Pakistan (Audit and Accounts) Order 1973, provides that the Auditor-General will be responsible for keeping the accounts of the Federation and of each Province, other than certain specified entities. The Order is issued subsequent to Article 170 of the Constitution of the Islamic Republic of Pakistan which states that ‘the accounts of the Federation and of the Provinces shall be kept in such form and in accordance with such principles and methods as the Auditor-General may, with the approval of the President, prescribe’.
- 1.4.4.5 In the event that an accounting policy or a procedure in this Manual conflicts with other manuals or directives, other than those amending this Manual, the accounting policy or procedure in this Manual will prevail.
- 1.4.4.6 Centralised entities shall not implement accounting policies or procedures in conflict with, or contrary to, those set out in this Manual. The self-accounting entities may formulate detailed accounting policies and procedures in pursuance of the MAP with the approval of the Auditor-General.

#### **1.4.5 Distribution, maintenance and update**

- 1.4.5.1 The Auditor-General of Pakistan is responsible for:
- the initial issue of the Manual to all Accountant General offices, District Account offices and the Principal Accounting Officers of centralised and self-accounting entities
  - the maintenance and update of the Manual, including distribution of any updates or amendments to all Accountant General offices, District Account offices and the Principal Accounting Officers of centralised and self-accounting entities.

1.4.5.2 In each Accountant General office, District Account office and for each centralised and self-accounting entity, the AG/DAO/ PAO is responsible for ensuring that:

- initial copies of the Manual are distributed to all Accounts Officers within their entity
- all subsequent updates and amendments of the Manual are distributed to all Accounts Officers within their entity.

# 2 Overview

---

## Table of Contents

<b>2.1</b>	<b>Introduction</b>	<b>2.3</b>
<b>2.2</b>	<b>Organisational Structure of the Accounting System</b>	<b>2.4</b>
2.2.1	Accounting entities	2.4
2.2.2	Responsibilities	2.4
<b>2.3</b>	<b>The Accounting System</b>	<b>2.8</b>
2.3.1	Key principles of the accounting system	2.8
2.3.2	Key accounting control objectives and respective controls	2.8
2.3.3	Key reporting control objectives and respective controls	2.11
<b>2.4</b>	<b>Outline of Chapters</b>	<b>2.13</b>
<b>2.5</b>	<b>Abbreviations</b>	<b>2.15</b>
<b>2.6</b>	<b>Definitions</b>	<b>2.17</b>

## **2.1 Introduction**

2.1.1.1 This chapter sets out in overview both the organisational structure and the system of accounting to be followed by the Federal and Provincial Government.

2.1.1.2 This chapter also provides a brief overview of each chapter within the Manual.



---

## 2.2 Organisational Structure of the Accounting System

### 2.2.1 Accounting entities

2.2.1.1 The Government of Pakistan includes both the *Federal and Provincial Governments*.

2.2.1.2 There are four Provincial Governments (Balochistan, NWFP, Punjab and Sindh) and the one Federal Government.

2.2.1.3 The Federal Government of Pakistan and the Governments of each of the Provinces are separate accounting and reporting entities. Each government operates separate bank accounts with the State Bank of Pakistan.

2.2.1.4 Within the Federal and Provincial Governments there are both centralised and self-accounting entities.

2.2.1.5 A *centralised accounting* entity is any accounting entity for whom the AG/AGPR has the primary responsibility for the accounting and reporting of that entity. The centralised accounting entity operate through their respective single bank account called "Non-Food Account 1" which is controlled by AG/AGPR.

2.2.1.6 A *self-accounting entity* is any accounting entity for whom the Principal Accounting Officer has primary responsibility for the accounting and reporting functions (e.g. Forest). Self-accounting entities maintain their own accounting records and submit monthly accounts in the prescribed form to the Accountant General's offices for consolidation. Self-accounting entities do not necessarily operate through the same bank account as centralised accounting entities, such as Railways and Food. Some operate through an assignment or personal ledger account, while others operate the same bank account.

2.2.1.7 Additionally there are government entities which are *exempt* (as listed in Manual of Accounting Principles (MAP) Schedule 2)

### 2.2.2 Responsibilities

2.2.2.1 The Constitution of Pakistan sets out the primary accounting requirements of the governments and the role and responsibilities of the Auditor-General. Refer to the MAP for more detail.

2.2.2.2 The Government's accounting function is structured as a hierarchy with four levels.

2.2.2.3 First of all, the Auditor-General, has overall responsibility for the accounts of the Federal Government and the accounts of each of the

---

Provincial Governments.. The Auditor-General additionally provides the Combined Annual Accounts of the Federation and the Annual Appropriation Accounts to the President. In the case of the Provincial Government Appropriation Accounts are submitted to the relevant Governor.

- 2.2.2.4 The relationship between the Auditor-General , having ultimate responsibility, and the other levels is structured through a scheme of delegation of authority and reporting lines.
- 2.2.2.5 Secondly, the Accountant General Pakistan Revenues and the Accountants General are responsible for transactions at the Federal and Provincial Government level.
- 2.2.2.6 The *Accountant General Pakistan Revenues* (AGPR) is responsible for the centralised accounting and reporting of federal transactions. Additionally the AGPR is responsible for the consolidation of summarised financial information prepared by federal self-accounting entities. The AGPR receives accounts and reports from the DAOs, PAOs, Federal Treasuries and SBP/NBP, and provide Annual Accounts (to the AGP) and Consolidated Monthly Accounts (to the Federal Finance Division). There are AGPR sub-offices in each of the Provinces who also act as the DAO in respect of Federal Government transactions relevant to the Provincial Headquarters.
- 2.2.2.7 Each *Accountant General* (AG) is responsible for the centralised accounting and reporting functions within their respective Province, under the authority of the Auditor-General. Additionally the Accountant General is responsible for the consolidation of the summarised financial information prepared by provincial self-accounting entities. They receive accounts and reports from the DAOs and PAOs, and provide Annual Accounts (to the AGP) and Consolidated Monthly Accounts (to the Provincial Government, through the Provincial Finance Department). In addition each Accountant General also acts as the DAO in respect of the Provincial Headquarters.
- 2.2.2.8 There is a *Principal Accounting Officer* (PAO) in each Ministry/Division/Department. Within self-accounting entities the PAO has been delegated the authority by the MoF for the accounting functions and for preparing accounts for submission to the Accountant Generals. The PAO has the authority to control the financial management of the entity under him/her, within the limits prescribed by the Government. They also reconcile accounts with the AG/AGPR offices.

- 
- 2.2.2.9 Thirdly, the *District Account Officers* are responsible for the accounting functions of the districts. Each province is divided into districts. NWFP also have district agencies for tribal areas, which are separately funded by the Federal Government. The DAOs have the authority to pre-audit bills, issue payments and record government transactions at a district level. They receive reports from the DDOs and bank scrolls from the SBP/NBP and prepare reports for submission to the AG/AGPR offices. The DAO perform the above mentioned functions for both Federal and Provincial transactions occurring within his/her District. Separate accounting records are maintained for Federal and Provincial transactions. In turn the DAO reports both to the AG and AGPR sub-office.
- 2.2.2.10 As well as DAOs, departmental treasuries are established to record specific accounting transactions, such as Income Tax, Sales Tax, Customs and National Savings Treasuries.
- 2.2.2.11 Fourthly, the *Drawing and Disbursing Officers* (DDO) are responsible for the accounting, cash and personnel functions of specific entities within departments. Each district contains a number of entities each having a DDO. The DDOs have the authority to submit bills for pre-audit to the DAOs, and report to both the DAO of the district and the PAO of his/her entity/department.
- 2.2.2.12 At both the Federal and Provincial level, the Government's banker is the State Bank of Pakistan, with National Bank of Pakistan acting as its agent.

2.2.2.13 Overview of the accounting organisational structure.

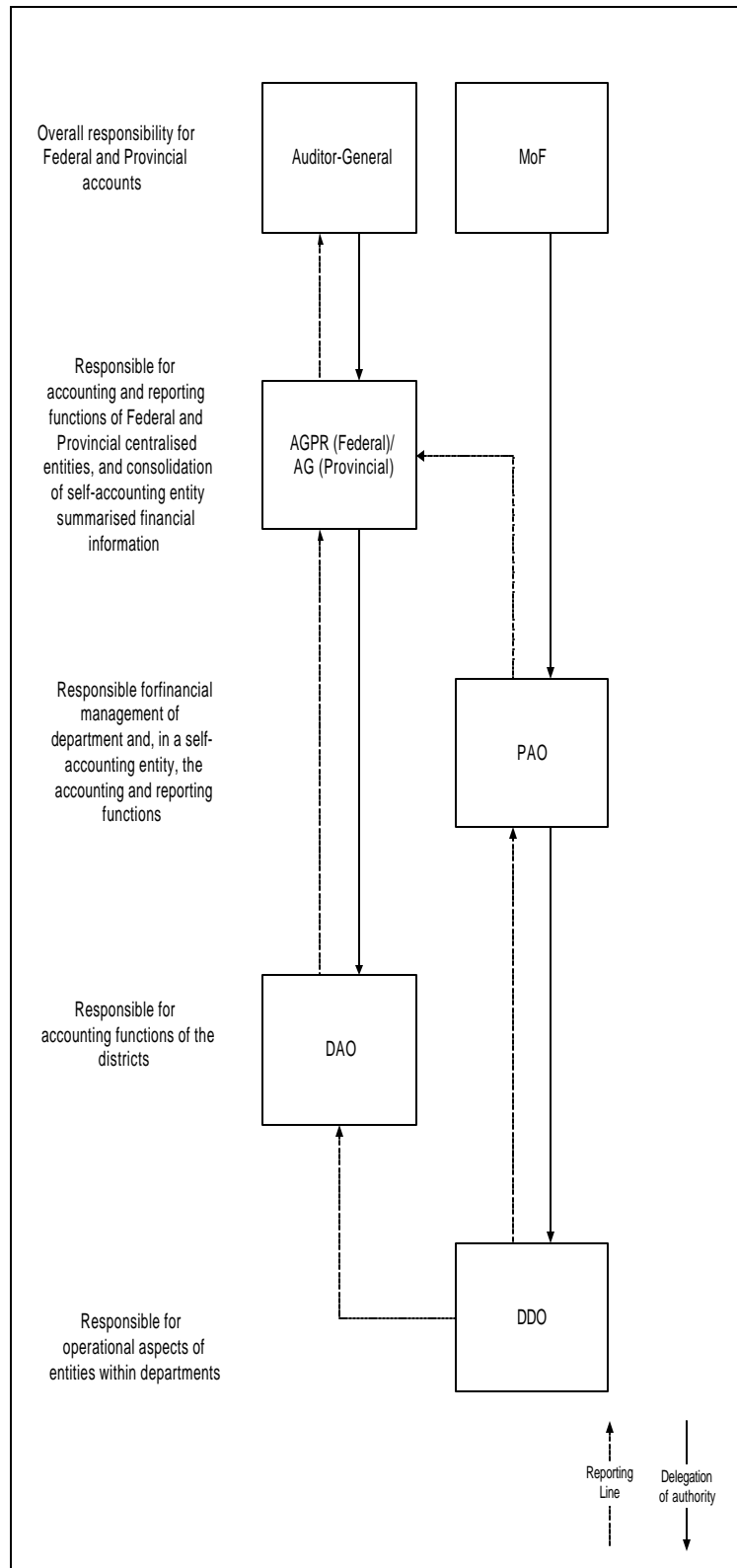

## 2.3 The Accounting System

### 2.3.1 Key principles of the accounting system

2.3.1.1 The key aspects of the accounting system shall be:

- double entry bookkeeping
- modified cash basis of accounting, record accounting transactions as per cashflow, with the following modifications:
  - commitment accounting, recognise and record significant commitments as they arise, through a purchase order or other legally binding contract
  - accounting for certain assets and liabilities,. At period end disclosure of all material assets and liabilities, in the Annual Accounts
  - physical asset accounting, systematically recognising the acquisition of physical assets, using asset registers in accounts offices.

### 2.3.2 Key accounting control objectives and respective controls

2.3.2.1 The following key control objectives and their respective controls are essential to the system of accounting operated at all levels in the Federal and Provincial Government. The controls detailed are in approximate chapter order. Some controls will meet a number of control objectives.

2.3.2.2 *Accuracy:* the information in the accounts and the supporting subsidiary records shall be accurate, representing the actual substance of past events, without undue errors or omission. This shall include correct and consistent classification of transactions and the recognition of revenues and expenditures in the correct time period. This objective shall be addressed by:

- budgetary control procedures
- a proper approval, certification and authorisation process for payments
- review and authorisation of payroll schedules by a delegated authority
- reconciliation of cheque/transfer advice to claim prior to signing by authorised signatory
- reconciliation of tax revenue receipts to tax authority records

- 
- a regular, complete and up-to-date bank reconciliation
  - procedures and control for recording inter-entity transactions
  - maintenance of physical assets register
  - performance of regular stocktakes
  - control over maintenance of permanent accounting records
  - procedures and control for making adjustments to accounting records
  - reconciliation of the general ledger to sub-ledgers, registers and source documents
  - detailed Chart of Accounts for classifying transactions
  - a regular post-audit process, both internal and external

2.3.2.3 *Completeness*: the information in the accounts and the supporting subsidiary records shall be a complete representation of all past transactions that have occurred during the reporting period. This objective shall be addressed by:

- budgetary control procedures
- recognition of significant commitments, using a commitments register
- regular checks for transactions not brought to account, using an outstanding claims register
- reconciliation of tax revenue receipts to tax authority records
- issue and review of sequentially numbered receipts for all revenue
- money shall in general be received by SBP/NBP
- regular, complete and up-to-date bank reconciliation
- physical assets shall be recorded in a register disclosed in a memorandum account
- regular and systematic, review and clearance of suspense accounts
- reconciliation of general ledger to sub-ledgers, registers and source documents
- a regular post-audit process, both internal and external
- a systematic and verifiable consolidation of accounts from subsidiary ledgers, registers and source transactions.

2.3.2.4 *Existence/Validity*: all transactions accounted for must be genuine transactions. This objective shall be addressed by:

- a proper approval, certification and authorisation process for payments

- 
- claims shall be stamped as paid on authorisation for payment
  - audit trail from the payment to the source documents supporting the claim
  - review and authorisation of payroll schedules by a delegated authority
  - reconciliation of cheque/transfer advice to claim prior to signing by the delegated authority
  - no duplicate receipts provided
  - regular, complete and up-to-date bank reconciliation
  - performance of regular stocktakes
  - maintenance of physical assets register, including procedure for disposal and existence checks of assets
  - a regular post-audit process, both internal and external.

2.3.2.5 *Economy*: the accounting system shall include controls to ensure the prudent allocation of government resources. This objective shall be addressed by:

- expenditure approval, certification and authorisation procedures
- a competitive procurement process
- central purchasing facilities
- asset management policies and procedures.

2.3.2.6 *Effectiveness*: the accounting system shall include controls to ensure the effective performance of government responsibilities. This objective shall be addressed by:

- clearly defined responsibilities, scheme of delegation and reporting lines
- comprehensive procedure notes
- human resources program including recruitment, training and appraisal.

2.3.2.7 *Efficiency*: in practice there will often be a trade off between economy and effectiveness. The accounting system should seek to operate as efficiently as possible by optimising the relationship between these two variables. This objective shall be addressed by:

- pre-audit (certification) of payments.
- issue of payment through direct bank transfer
- use of imprest system for small payments
- collection of revenue through SBP/NBP

- 
- hierarchical organisational structure in which there is a clear scheme of authority delegation to perform the tasks
  - responsibility accounting, using responsibility centres
  - production of annual and monthly financial reports
  - limited duplication of roles
  - consolidation of accounts.

2.3.2.8 *Minimise risk of fraud and corruption:* the accounting system shall include controls to minimise the risk of fraud and corruption. This objective shall be addressed by:

- segregation of duties, so that certain accounting functions should be performed by different officers, including:
  - accounts and audit
  - recording of receipts and collection of money
  - approval/authorisation and issue of payment.
  - recording of expenditures and issue of payment
- budgetary control procedures
- pre-audit of claims for payment
- maintenance of an authorised signatories list by the bank
- requirement of a double signatory for issue of payment
- issue of payment through direct bank transfer and cheques
- maintenance of a physical assets register
- performance of regular stocktakes
- control over maintenance of permanent accounting records
- procedures and control for making adjustments to accounting records
- reconciliation of the general ledger to sub-ledgers, registers and source documents
- responsibility accounting, using responsibility centres
- clearly defined responsibilities, scheme of delegation and reporting lines
- a regular post-audit process, both internal and external

### **2.3.3 Key reporting control objectives and respective controls**

2.3.3.1 *Sufficient:* the accounting system must produce sufficient information for the adequate control of the government's finances. This objective shall be addressed by:



- 
- preparation of monthly and annual accounts
  - availability of an audit trail through sub-ledgers, registers and source documents to substantiate the financial reports
  - preparation of additional operational information by entities as required
  - on-going review of information requirement by users.

2.3.3.2 *Relevance*: the accounting system must produce financial information which is relevant and understandable to the users of the information. The financial reporting from the accounting system must be based on the accountabilities required of users, and their decision making requirements. This objective shall be addressed by:

- on-going review of information requirement by users.

2.3.3.3 *Reliable*: the accounting system shall produce reliable financial information. This objective shall be addressed by the controls over completeness, accuracy and validity.

2.3.3.4 *Consistency*: the accounting system must enable consistent information to be produced in financial reports, in order to be useful for decision making. This objective shall be met by:

- a consistent reporting period and unit of currency
- consistent accounting basis and policies
- consistent reporting formats and disclosures
- accounting policies consistently applied across all government entities.

---

## 2.4 Outline of Chapters

2.4.1.1 This manual is structured according to the major financial management activities of the Government. A summary of these chapters is provided below:

- *Introduction*: introduction to the Manual, detailing its purpose, structure and applicability
- *Overview*: overview of the accounting organisational structure and system
- *Budgetary control*: overview of the budgetary cycle and the detailed procedures involved in policy setting and the preparation, authorisation, implementation, reporting, monitoring and review of budgets
- *Expenditures*: policies, accounting treatment and procedures to be applied for expenditures, and all stages of payment processing. The chapter also includes procedures for specific types of payment and maintenance of permanent records
- *Receipts*: policies, accounting treatment and procedures in relation to receipts
- *Bank reconciliation*: policies and procedures for the bank reconciliation
- *Financial reporting procedures*: procedures for the preparation and consolidation of accounts, including periodic adjustments and annual financial statements
- *Loss and recoveries of public money*: write-off and recoveries of public money, also recovery of amounts owed on account of loans and advances given to provincial government, local bodies and government employees which are outstanding
- *Self-accounting entities*: policies, accounting treatment and reporting for self-accounting entities
- *Project accounting*: policies and procedures for development projects
- *Accounting for liabilities*: procedures relating to public debt transactions undertaken by the Government, including internal and external borrowings
- *Transactions between government entities*: policies, accounting treatment and procedures for transactions between Government entities

- 
- *Procurement and asset management:* accounting policies and procedures relating to Government procurement, including purchasing, management and disposal of stores and physical assets
  - *Public account transactions:* describes the public account and deals with specific aspects of the public account not previously covered in the Manual
  - *Insurance:* accounting policies in relation to insurance
  - *General accounting:* procedures for the recording and maintenance of Government records. Includes use of suspense accounts and control of official forms and chequebooks
  - *Assignment accounts and personal ledger accounts:* policies and procedures relating to usage of assignment accounts and personal ledger accounts.

---

## 2.5 Abbreviations

The following abbreviations are used in the Manual:

AG	Accountant General
AGP	Auditor-General of Pakistan
AGPR	Accountant General Pakistan Revenues
APPM	Accounting Policies and Procedures Manual
CBR	Central Board of Revenue
CG	Comptroller-General
CMA	Consolidated Monthly Accounts
CoA	Chart of Accounts
CQA	Consolidated Quarterly Accounts
DAO	District Accounts Office/Officer
DDO	Drawing and Disbursing Officer
DGPR	Director General Pakistan Revenues
EAD	Economic Affairs Division
FRM	Financial Reporting Manual
IAS	International Accounting Standards
GAAP	Generally Accepted Accounting Principles
GFS	Government Financial Statistics
GoP	Government of Pakistan
MAP	Manual of Accounting Principles
MDB	Main Designated Branch
MDMBS	Monthly Designated Main Branch Statement

MoF	Ministry of Finance
NBP	National Bank of Pakistan
NIS	New Items Statement
PAO	Principal Accounting Officer
PAC	Public Accounts Committee
PAD	Pakistan Audit Department
SAE	Schedule of Authorised Expenditure
SE	Self-Accounting Entity
SBP	State Bank of Pakistan

## 2.6 Definitions

The following are definitions of terms commonly used in this Manual:

abstract	An intermediate schedule prepared to facilitate the consolidation of financial information.
accounting entity	This term includes the centralised accounts offices including the Executive Engineer of a public works division and the self-accounting offices.
accounts office	This term identify the offices carrying out the accounting work and typically includes the offices of the DAO, AG and AGPR.
accounting period	The time period over which financial information is reported, normally either a year or a month.
accounting policy	A set of specific rules which defines how a particular transaction will be treated and accounted for in the books of accounts. Where accounting policies are laid down in this manual, they always relate to specific treatment of a specific type of transaction.
accounting record	Any document upon which accounting transactions are recorded or any other document issued or used in the preparation and processing of accounting transactions.
accrual accounting	A method of accounting that recognises expenses when economic benefits have been consumed and revenues when economic benefits have been generated.
advance	An amount paid by the Government to a contractor/supplier for the purpose of securing goods or services; or an amount provided to a Government employee for a specified purpose, and to be adjusted as per terms and condition of the advance.
advice note	A list of authorised payments sent by an accounts office to a branch of the SBP or NBP. (includes daily advice, payroll advice, pension advice, direct credit advice)
Annual Financial Statements	A set of financial reports, produced after the close of the financial year by the Auditor-General of Pakistan for the Federal and each of the Provincial Governments.

---

appropriation	An allocation of funds to a spending ministry or department on the basis of the Authenticated Schedule of Authorised Expenditure.
approval	The permission given by an authority or a delegated authority to undertake a particular action, such as incurring expenditure.
asset	Future economic benefits controlled by the entity as a result of past transactions or other past events. (MAP, Section 3.3).
assignment account	A Government bank account established with the NBP, to provide independent drawing facility for nominated projects and other activities, within the prescribed limitation.
attached department	A department which has direct relation with a Division and has been declared as such by the Federal Government and represented in the Chart of Accounts entity code.
audit trail	The capability to trace a particular balance from the financial statements down to its source documents (and vice versa), as evidence that the balance is complete and accurate.
authorisation	(i) In accounting terms, the approval given by an authority or a delegated authority for a particular payment to be made.  (ii) In the context of the Budget, the process of passing the Annual Budget Statement through the legislature for approval.
the Bank	State Bank of Pakistan, or The National Bank of Pakistan, as an agent of the SBP, unless otherwise specified.
bank return	A batch of documents received from the bank including the bank scroll, supporting vouchers, paid cheques and other documents.
bank scroll	A daily advice received from a designated branch of the National Bank of Pakistan or State Bank of Pakistan, listing receipt collected and payments disbursed on behalf of the Government, against each of the Government bank accounts.
Budget	Defined in article 80 of the Constitution, a statement of the estimated receipts and expenditure of the Government for a financial year, referred to as the Annual Budget Statement.

---

---

capital expenditure	<p>(i) For the purposes of budgeting, expenditure met from capital receipts, as given by a particular grant number in the Chart of Accounts.</p> <p>(ii) In accounting terms, expenditure incurred for the purpose of acquiring, constructing or enhancing physical assets or on schemes of capital outlay, as given by the object code in the Chart of Accounts.</p>
capital receipt	<p>(i) For the purposes of budgeting, receipts obtained from sources of finance other than revenue (e.g. loans).</p> <p>(ii) In accounting terms, receipts generated from the proceeds of sale of physical assets or receipts intended to set-off capital expenditure.</p>
cash accounting	A method of accounting that records cash payments and cash receipts only.
cash balance	The amount held in a particular bank account at any point in time.
Cashflow	The net movement in the cash balance over a particular reporting period, given by the sum of payments and receipts.
Cashflow Statement	A financial report provided to show the net movement in cash over a particular reporting period, showing how and where the cash has been applied.
cashflow forecast	An estimate made of likely future cashflows based on historical patterns of expenditures and receipts, knowledge of expected payments (commitments) and collections (demands), changes in Government policy and other factors.
centralised accounting entity	Any accounting entity for which the Accountant-General is responsible for the processing of its accounting transactions (e.g. certifying, authorising and issuing payments) and maintaining its accounts.
certification	A process undertaken by the DAO/AG/AGPR, including Executive Engineer of a public works division, involving verification (proper approval and validity) and audit (scrutiny against irregularities) of a payment prior to it being made. (previously referred to as pre-audit).

---



---

charged expenditure	As defined in Article 81 of the Constitution, certain expenditures met from the Consolidated Fund, which may be discussed, but not submitted to the vote of the National Assembly (or Provincial Assembly in the case of Provinces).
chart of accounts	A listing of codes on the basis of which accounting transactions are classified to provide meaningful financial information.
claim voucher	A document submitted by DDOs to the DAO/AG/AGPR office, containing the particulars of a valid and duly approved claim for payment against a nominated budget head. (previously referred to as a bill).
clearing account	A type of General Ledger account which is used to transfer a balance from one entity or process to another (includes exchange and settlement accounts).
commitment	An obligation to make a future payment, the funds for which are reserved against the allocated budget of an entity.
Consolidated Financial Statements	A set of financial reports produced by the Pakistan Audit Department which presents a consolidated summary of the Annual Accounts of the Federation and each Province.
Consolidated Fund	Defined in Articles 78 and 118 of the Constitution, refers to all revenues received by the Federal/ Provincial Government, all loans raised and all moneys received in repayment of any loan by that Government.
Consolidated Monthly Accounts	The Monthly financial reports produced by the AG/AGPR, which present a summary of the accounts of the Federation/Provinces.
consolidation	Aggregation of information from several entities to present as if one entity, therefore eliminating transactions between the entities being consolidated.
contingent expenditure	All non-development expenditure, other than salaries and salary related expenditure.
control account	A type of general ledger account which summarises a number of transactions from a subsidiary ledger into a single balance.
delegated authority	An officer formally empowered by the responsible authority to perform a particular function.

---

---

department	The equivalent level of a Division, in the case of Provincial Governments, as given by the Rules of Business and listed in the Chart of Accounts entity code.
development expenditure	Expenditure provided in grants, relating to development projects. Development projects are projects undertaken to acquire, build or improve physical assets or develop human resources.
direct credit	A facility provided by the banks which allows salaries and other employee related payments to be made directly into the bank accounts of those persons, without the need for an exchange of physical cash or cheques.
disclosure	Display of financial information in a supplementary note to the financial statements, rather than in its main body, in order to provide further detail about a particular item.
district	A distinct region within a Province, as determined by the Government and shown in the Chart of Accounts entity code.
division	A self contained administrative unit responsible for the conduct of business of the Federal Government in a distinct and specified sphere and declared as such by the Federal Government and included in the Chart of Accounts entity code.
double entry system	A system of recording accounting transactions which requires all journal entries (inputs) to the General Ledger to be in balance, i.e. total debits equal total credits.
entity	An organisational unit of Government. This term can be applied to specific types of organisational units, depending on the context (i.e. self-accounting entity, centralised accounting entity, spending entity).
equity	An accrual accounting concept defined as the residual interest in the assets of an entity after the deduction of all its liabilities.
exchange account	A General Ledger account through which transactions between centralised accounting entities and self-accounting entities of the Federal Government are recorded.
excess	An amount of expenditure exceeding the approved budget, which is regularised through an Excess Budget Statement.

---

---

exempt entity	Any entity outside the scope of the Manual of Accounting Principles and related manuals.
expense	<p>(i) In accrual accounting, defined as a decrease in future economic benefits in the form of reductions of assets or increases in liabilities of the entity, other than those relating to distributions to Government as owner, that result in a decrease in equity (MAP, Section 3.3).</p> <p>(ii) In cash and modified cash accounting, defined as the outflow of cash arising as a result of payments issued in a given reporting period.</p>
financial asset	A reporting classification of assets, used to describe cash held and any assets readily convertible to cash.
financial year	The financial year commencing 1 July and ending 30 June, consisting of twelve monthly periods.
fixed assets	Assets characterised by their long-term or strategic purpose. Fixed assets are usually physical in nature, such as plant and equipment, buildings etc. In financial reporting, used synonymously with 'non-financial assets', because they are not readily convertible to cash.
flowchart	A graphical display used in these manuals and other documentation, to represent the flow of information and controls within a process or group of processes.
function	An element used in the Chart of Accounts, which provides financial information on particular economic activities, according to the International Monetary Fund's Government Finance Statistics (GFS) classification scheme.
fund	A pool of money, set aside and used for an intended purpose, as provided by legislation or special orders (e.g. Consolidated Fund, trust fund).
funds available	A term used in budgetary control to describe the remaining budget allocated to an entity, after deducting outstanding commitments and actual payments.
general ledger	The primary ledger in which accounting transactions are recorded, in double entry format, and from which financial reports are produced.

---

---

general policy	A set of general rules which defines how a transaction is treated in the books of accounts. Unlike accounting policies, a general policy describes the overall treatment of a transaction.
grant	Funding provided to a Ministry or Department, through the Schedule of Authorised Expenditure.
imprest account	Petty cash system for making small payments. Contains a set balance of cash which is subsequently replaced by petty cash vouchers on payment of cash.
internal controls	A term used to describe the system of checks, reports and procedures that are enforced in an accounting system to protect against fraud and to ensure complete and accurate financial information is produced.
journal entry	a uniquely numbered input voucher to the General Ledger, containing accounting transactions, used in the double-entry recording system.
liability	Future sacrifices of economic benefits controlled by the entity as a result of past transactions or other past events. (MAP, Section 3.3).
materiality	An amount is material to the accounts if its omission or misstatement is likely to influence the economic decisions made by the users of the information.
memorandum account	An account maintained separately to the General Ledger but still operated within the internal control process. Information recorded in memorandum accounts is used to provide supplementary information to the Financial Statements.
modified cash	A method of accounting in which all cash payments and receipts are recorded, along with certain assets and liabilities/commitments
non-development	Expenditure provided for in grants, relating to the on-going costs of Government, such as salaries and allowances of employees and contingent expenditures.
object	A Chart of Accounts element used to classify financial information according to the IAS accounting requirements (e.g. asset, liability, revenue, expenditure, equity), and

---

---

	provide sub-classifications therein (e.g. salaries, travel, transport).
obligation	Obligation in the context of commitment means the legal requirement to honour the terms of a contract rather than the term “commitment” which is used in its accounting context.
payroll section	The section within the DAO responsible for preparing the payroll.
permanent record	A record required to be maintained in order to generate accounting transactions, but is not in itself a transaction. (e.g. payroll records, GP fund records, pension records).
personal ledger	A ledger account maintained by the DAO/AG/AGPR, established as a drawing facility for nominated purposes.
Public Account	Defined in Article 78 of the Constitution, all other moneys received by or on behalf of the Federal Government, other than the Consolidated Fund, or deposited with the Supreme Court or any other court established under the authority of the Federation.
public debt	The total liability arising from the borrowings of the Government, including both domestic loans and foreign (or external) loans.
receipt	(i) An amount of cash collected or the process of collecting money.  (ii) An official document provided to a payer, as proof that money was received.
receipt voucher	A form with which amounts collectable by the Government are deposited with the bank, containing the particulars of the receipt. (previously referred to as a challan).
recognise	Reported on, or incorporated in amounts reported on, the face of the financial statements of the entity.
reconciliation	A process of substantiating recorded financial information against an alternative source of data (e.g. bank reconciliation, reconciliation between accounts offices and spending departments).

---

---

release	A sanction given by Ministry of Finance, permitting a particular budgetary allocation to be spent, on the basis of cash being available.
revenue	(i) In accrual accounting, defined as increases in future economic benefits in the form of increases or enhancements of assets or decreases of liabilities, other than those relating to contributions by the Government as owner, that result in an increase in equity. (MAP, Section 3.3).  (ii) In cash and modified cash accounting, defined as an inflow of cash, arising as a result of collections received in a given reporting period.
self-accounting entity	Any accounting entity that performs its own accounting function and maintains its own accounts, including certification, authorisation and issue of payments.
settlement account	A General Ledger clearing account through which cash transactions between governments are recorded.
Special Deposits	Accounts comprising of Public Account moneys that are operated under the authority of Ministry of Finance, but are not trust accounts.
Statement of Assets and Liabilities	A financial report consisting of balances of assets and liabilities for an entity, as at a particular period end date. Set out in the Financial Reporting Manual.
Statement of Revenues and Expenditures	A financial report consisting of balances of revenues and expenditures for an entity, over a given reporting period. Set out in the Financial Reporting Manual.
sub-ledger	Book of initial entry of all accounting transactions in a particular accounting office, for subsequent double entry into the General Ledger.
Supplementary Budget	Provided in Article 84 of the Constitution, an additional budget statement laid before Parliament, where funding for an existing service is insufficient, or the need for a new services has arisen which was not included in the original budget.
surrender	An amount included in the original approved budget, that is given back because it has not or will not be spent in the financial year by the entity.

---

---

suspense account	An account used if the correct head to be debited or credited is unable to be identified at the time of transaction, which shall be cleared once the correct head is identified.
Trust Account	Legal entities in their own right, under the stewardship of the Government, and as such expected to produce financial statements in their own name. Trust accounts are normally established under an Act of Parliament or Presidential Order.
voted expenditure	As defined in Article 82 of the Constitution of Pakistan, that part of the Annual Budget Statement relating to other expenditure, submitted to the National Assembly in the form of demands for grants, on which the Assembly votes.

# 3 Budgetary Control



---

## Table of Contents

<b>3.1</b>	<b>Introduction</b>	<b>3.3</b>
<b>3.2</b>	<b>General Policies</b>	<b>3.5</b>
3.2.1	Responsibilities for budgeting	3.5
3.2.2	General budget classifications	3.5
3.2.3	Method of budgeting	3.6
3.2.4	Budget format	3.7
<b>3.3</b>	<b>Detailed Procedures</b>	<b>3.8</b>
3.3.1	Introduction	3.8
3.3.2	Budgeting procedure - overview	3.9
3.3.3	Policy setting and issue of Budget Call Circular	3.9
3.3.4	Preparation of non-development budget	3.10
3.3.5	Preparation of non-development (permanent) budget	3.10
3.3.6	Preparation of non-development (temporary) budget	3.13
3.3.7	Preparation of development budget	3.13
3.3.8	Preparation of receipt estimates	3.16
3.3.9	Consolidation of budget data	3.17
3.3.10	Authorisation	3.17
3.3.11	Implementation	3.17
3.3.12	Reporting and monitoring	3.18
3.3.13	Supplementary Grants	3.20
3.3.14	Review	3.20
<b>3.4</b>	<b>Specific Budgetary Procedures</b>	<b>3.22</b>
3.4.1	Introduction	3.22
3.4.2	Charged Expenditures	3.22
3.4.3	Centrally provided for expenditures	3.22

### 3.1 Introduction

3.1.1.1 In the public sector, the Budget is an instrument by which the Government expresses its priorities and allocates resources to implement its policies. The Budget is a tool by which planned expenditures are controlled, at all levels of Government, including spending ministries, departments and units.

3.1.1.2 The Budget applies only to the Consolidated Fund.

3.1.1.3 Under the Constitution, the Federal/Provincial Government is required annually to lay before the National/Provincial Assembly, a statement of estimated receipts and expenditure for the forthcoming financial year. This is referred to as the Annual Budget Statement. This statement indicates separately the sums required to meet expenditure charged upon the Federal/Provincial Consolidated Fund and other expenditure to be made from the Federal/Provincial Consolidated Fund.

3.1.1.4 The budgeting cycle consists of six phases broadly categorised as follows:

- *setting of budget policy and initiatives*: the Cabinet meets to determine budget policy, initiatives and priorities. These are then communicated to ministries and departments via the Finance Division/Department and Financial Advisors in the case of Federal Government.
- *preparation*: this stage includes the preparation and submission of budget estimates of expenditure and receipts by entities and subsequent review and consolidation of estimates by the Financial Advisors (in the case of Federal Government) and the Finance Division/Department.
- *authorisation*: this stage involves submission of the Annual Budget Statement before the National/Provincial Assembly. This consists of two stages; approval by the National/Provincial Assembly, and authentication by the Prime Minister/Chief Minister. The approved budget is referred to as the 'Schedule of Authorised Expenditure'.
- *implementation*: this stage refers to the communication of the budgets to the spending ministries and departments via the Finance Division/Department and the Financial Advisor in the case of Federal Government. On implementation of the Budget, the entity can carry out activities and incur expenditure, for which funding has been given in that period.
- *reporting and monitoring*: actual revenues and expenditures (including commitments) are recorded and reported to monitor

progress against budget throughout the financial year. Reporting assists managers in decision making and in particular re-allocation of funds where required (Chapter 7). This includes the provision of both internal and external reports.

- *review*: the periodical review of financial performance and the achievement of policy objectives by spending agencies and external review bodies. This includes audit activities and review by Public Accounts Committee. At year end outstanding commitments are reviewed and budget provision (through supplementary grant) made for the following year. For Revised Budget Estimates see 3.3.5.3 and 3.3.13.

3.1.1.5 The budgetary cycle is represented in the following diagram.

### Overview of the Budgetary Cycle

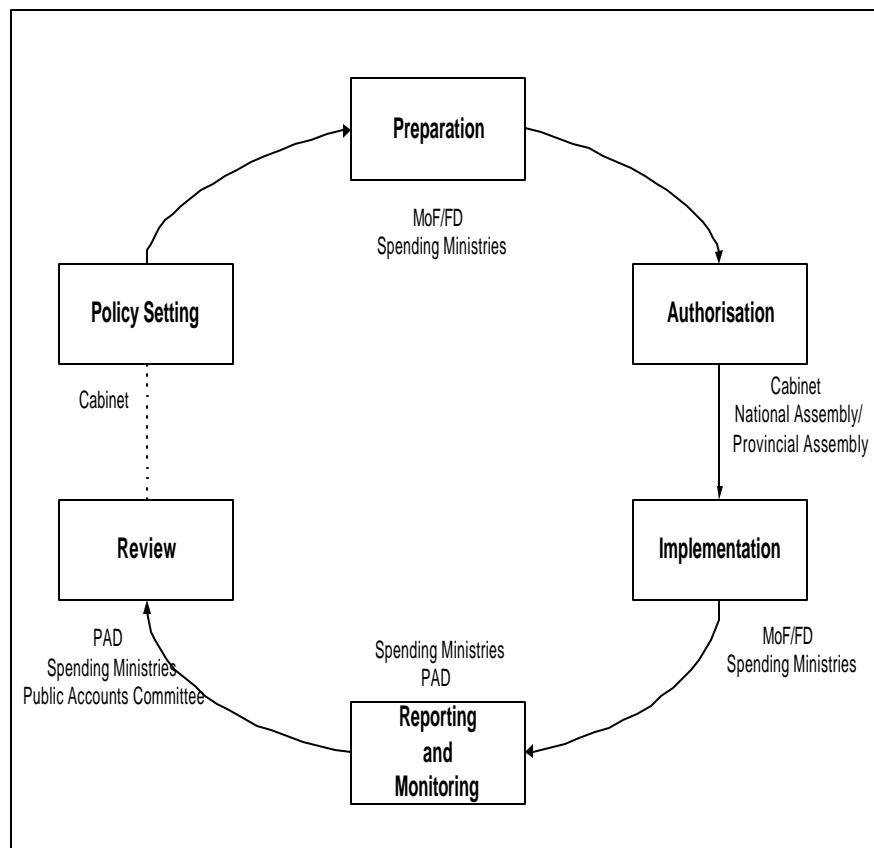

---

## 3.2 General Policies

### 3.2.1 Responsibilities for budgeting

3.2.1.1 Spending ministries are responsible for the preparation of their own budget estimates. In each ministry there is a Financial Advisor who is under the administrative control of the Finance Division/ Department. This officer guides the preparation of estimates by spending entities within the ministry and co-ordinates the budget with the Finance Division/Department and various other bodies as required throughout the budget cycle.

3.2.1.2 A number of other Government entities provide support during the budget process. These include various committees responsible for the review and approval of budget proposals (as nominated from time to time by the Ministry of Finance), including:

- the Planning Commission
- the Economic Affairs Division
- the Accountant General.

### 3.2.2 General budget classifications

3.2.2.1 The estimates provided in the Annual Budget Statement must be shown in accordance with Constitutional requirements. Under the Constitution the budget estimates must show separately:

- the sums required to meet expenditure charged upon the Federal/Provincial Consolidated Fund (refer to Direction 3.4.2.1. for a list of items included as charged expenditures)
- the sums required to meet other expenditure, other than charged, proposed to be made from the Federal/Provincial Consolidated Fund.

3.2.2.2 Within these overall requirements, spending ministries and departments are required to submit budget estimates in prescribed classifications. On the expenditure side, separate estimates are prepared for current and development expenditures. Separate forecasts are also prepared for receipts. The classification of current and development expenditure needs to be sub-classified into their Foreign Exchange and Rupee components both denominated in rupees.

3.2.2.3 Non-development expenditures refer to the on-going administrative operations within a ministry or department, in fulfilling its policy objectives. These include salaries and allowances of officers and staff.

---

There are two types of non-development budget; permanent and temporary:

- *permanent budget*: these are non-development expenditures that have previously been approved and are continuing. These include permanent staffing establishments, travelling, fixed allowances and contingent expenditure. This is submitted as the 'Part I' budget
- *temporary budget*: these are new items of non-development expenditure such as temporary additions to existing establishments or services that have either continued on from year to year on a temporary basis or have been newly sanctioned and not included in the current year's budget. This is submitted as the 'New Items Statement' (NIS) or 'Part II' budget.

3.2.2.4 Development expenditure refers to activities conducted and managed distinctly as individual projects, with finite start and end dates and clearly specified deliverables. Development projects typically involve the construction or improvement of physical assets or the development of human resources. Development projects are submitted as 'New Item Statements'.

Development budgets should have a flow-on effect to the non-development budget. When a development project is completed it should result in new items of non-development expenditure, such as salaries, maintenance and utilities.

3.2.2.5 Forecasts of revenue shall be prepared by those entities responsible for administration of those revenues. This includes tax authorities such as the Central Board of Revenue in the Federal Government and the respective Excise and Taxation Departments in the Provinces.

### 3.2.3 Method of budgeting

3.2.3.1 The method used by ministries and departments for preparing budget estimates will be determined by the Finance Division/ Department. Irrespective of the type of expenditure or method of budgeting used, the estimates provided to the Finance Division/ Department must be fully substantiated.

3.2.3.2 Ministries and their subordinate spending entities should frame their budgets according to planned outcomes and not inputs. For example, a ministry should first consider what outcomes it wishes to achieve against a particular function or program, rather than how many new staff it wishes to employ. Development and non-development budget estimates should be considered jointly, in order to determine whether the planned outcomes of the entity (and those of the Government as a whole), can be met.

3.2.3.3 Estimates of expenditure are to be provided on a cash basis, that is, expenditure incurred when payment is made within the financial year. This is consistent with the accounting policy for the recognition of expenditure.

3.2.3.4 Forecasts of revenue are to be prepared on a cash basis, that is, based on what can reasonably be expected to be paid and collected in the financial year. This will be calculated from prior year collection figures, adjusted for changes in revenue collection policy. The forecasts will be provided in gross amounts (e.g. revenues will not be shown net of any related costs). This is also consistent with the related accounting policy for the recognition of revenues.

### **3.2.4 Budget format**

3.2.4.1 The format by which budget estimates are to be submitted, consolidated and ultimately presented before the National and Provincial Assemblies will be the same, as determined by Finance Division, in consultation with the respective Provincial Finance Departments.

3.2.4.2 The budget will be compiled to be consistent with the Chart of Accounts specifications.

### **3.3 Detailed Procedures**

#### **3.3.1 Introduction**

3.3.1.1 This section describes steps to be followed in the budgetary procedure, based on the components of the budgetary cycle as outlined in the Introduction (Direction 3.1.1.4).

3.3.1.2 These procedures refer to the budgeting process in general and, unless otherwise specified are applicable to all spending entities. Ministries and departments will ensure procedures for the collection of subsidiary details and the preparation and scrutiny of budget estimates are laid down in departmental regulations of the ministries and departments.

3.3.1.3 From time to time the Finance Division/ Department will issue orders pertaining to budgetary procedures. These include specific orders for a financial year or a particular class of expenditure. Such instructions are to be followed in conjunction with the procedures contained in this Manual.

3.3.1.4 The following key controls are essential to the budgeting process:

- all budget estimates for a ministry or department must be reviewed and signed off by the Financial Advisor before it is submitted to the Finance Division/ Department
- all budget estimates for a ministry or department must be approved and signed off as evidence by the Financial Advisor before it is submitted to the Finance Division/ Department
- budget estimates and supporting schedules must be prepared in a prescribed format
- the budgets must be authorised by the National/Provincial Assembly
- authorised budgets must be communicated to the Accountant General so that a complete record is maintained for verification and authorisation of payment
- the Finance Division/Department must communicate the authorised budgets to the spending ministries and departments through release letters
- the Principal Accounting Officer for each entity must monitor actual transactions against budget.

**3.3.2 Budgeting procedure - overview**

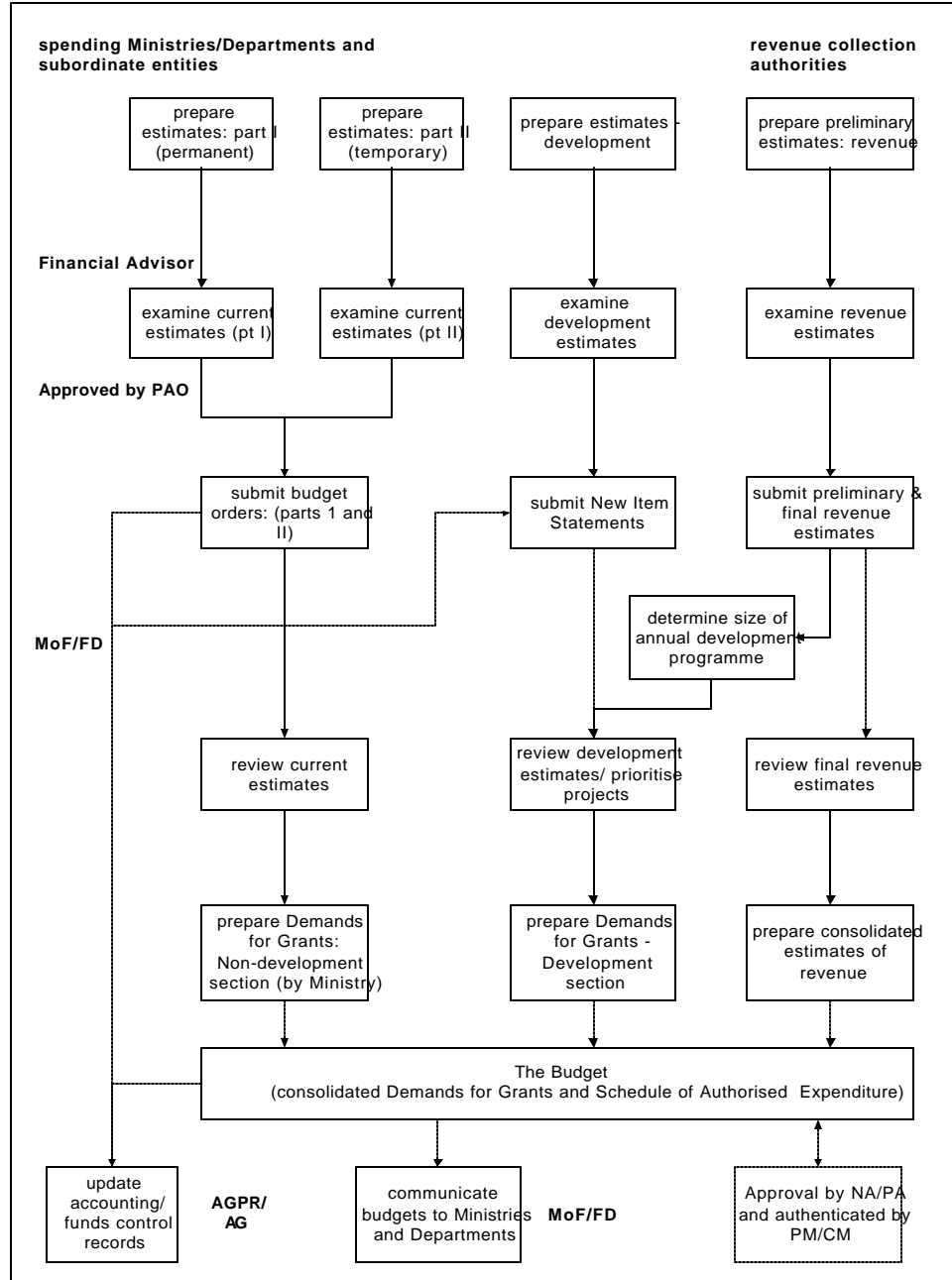

**3.3.3 Policy setting and issue of Budget Call Circular**

3.3.3.1 Each year, the Cabinet must meet and set out the budget policy, including new initiatives, targets and priorities. The budget policy will establish the planned surplus or deficit, with underlying assumptions on economic growth, inflation and other planning parameters.



3.3.3.2 After the Cabinet has set the budget policy, the Finance Division/ Department will prepare and issue the Budget Call Circular. This document sets out the timetable in which budget estimates are to be provided by the spending ministries and departments and any other relevant instructions to be followed.

3.3.3.3 The deadlines for submission of estimates shown in the following sections are indicative only, as they will vary from year to year and between individual provinces. In all cases the dates shown in the Budget Call Circular shall be adhered to.

### **3.3.4 Preparation of non-development budget**

3.3.4.1 After the Budget Call Circular is issued, ministries and departments shall prepare detailed estimates of their non-development expenditure for the forthcoming financial year.

3.3.4.2 Development budgets must be prepared on an integrated basis. permanent and temporary budget estimates must not be prepared independently of one another.

3.3.4.3 Estimates of non-development expenditure must show separately, within each grant:

- ‘charged’ and ‘other than charged’ expenditure
- expenditure on revenue account and expenditure on capital account.

3.3.4.4 The Principal Accounting Officers must approve and sign off the budgets relevant to their entities.

3.3.4.5 For each spending entity within a ministry, the level at which non-development estimates are to be submitted is as follows:

- for each grant, the grant and units of appropriation
- for each primary unit of appropriation, to the detailed levels of both function and object heads

### **3.3.5 Preparation of non-development (permanent) budget**

3.3.5.1 Estimates provided under the permanent (or Part I) budget, as defined in Direction 3.2.2.3, must only include items which have already been cleared by the Finance Division/ Department. If an item appears in these estimates for the first time, it must be supported by a copy of the approval for continuation of that item on a permanent basis.

- 
- 3.3.5.2 It should not be assumed that estimates provided under the permanent budget are fixed items. Spending ministries and departments should review their overall establishment requirements and patterns of contingent expenditure to identify potential savings when preparing their budget.
- 3.3.5.3 In order to form the basis for the following year budget estimates, revised estimates must be prepared for the current financial year. Revised estimates should be determined in light of:
- actuals for the first 4 months of the current financial year plus actuals for the last 8 months of the previous financial year
  - commitments entered into and expected to be paid in the current financial year
  - 12 months actuals for the previous two years
  - adjustments arising from:
    - re-appropriations within particular grants during the current financial year
    - new items of expenditure approved through Supplementary Budget during the current financial year
    - surrenders made or expected to be made during the current financial year.
  - any other relevant factors
  - the impact of development and non-development factors.
- 3.3.5.4 Where the revised budget exceeds the approved grant, the ministry or department must indicate how the excess is proposed to be met and the delegated authority who authorised the increase.
- 3.3.5.5 Where the revised budget is less than the approved grant by more than 5%, an explanation of the saving must be provided by the ministry or department.
- 3.3.5.6 Budget estimates for the next financial year are then prepared for each detailed head (detailed function and object within each unit of appropriation). For permanent budgets, the following information must be provided at detailed head level:
- actuals for the last financial year and budget variances for that year
  - budget estimate for the current financial year
  - revised estimate for the current financial year
  - budget estimate for the forthcoming financial year.

- 
- 3.3.5.7 From the information collected above, a statement will be prepared comparing the differences between:
- current year's approved grant and the revised estimate
  - the budget estimate submitted for the current year and the estimate for next year.
- 3.3.5.8 Budget estimates should be prepared to include subsidiary details in the prescribed form (e.g. nominal rolls, calculation of allowances etc.), and made available for scrutiny by the Ministry of Finance, if requested.
- 3.3.5.9 Other relevant factors should also be considered in developing an estimate for next year's budget. These include the following:
- adjustment for expected inflation as provided, increase in salary costs and any other planning assumptions provided in the budget call circular.
  - known deferred liabilities, as recorded on the Liabilities Register, for the next year.
  - anticipated savings arising from productivity gains, and reduction or termination of specific programs.
- 3.3.5.10 Estimates relating to approved establishments, both permanent and temporary, should take into account provisions for leave, expected vacancies and allowances payable to employees, based on past actuals and other relevant factors. Substantiation must be provided for variations from the previous year's establishment.
- posts which will not be filled must not be provided for. This includes provision for staff on long-term transfer or leave.
  - estimates of salaries must be supported by the number of posts against each establishment, and an explanation of any variation between the next year and the current year's posts.
- 3.3.5.11 Lump sum provision in the budget must not be made unless in exceptional circumstances. For example, the use of 'other' expenditure heads should be avoided, in favour of more clearly defined heads.
- 3.3.5.12 Permanent budget estimates must be submitted by the concerned spending entities to the Financial Advisor no later than *1 December* each year. Subsequently the Budget Orders pertaining to the permanent (Part I) budget must be submitted to the Budget Wing of the Finance Division/Department and copied to the Accountant General, no later than *1 January*

---

3.3.5.13 The dates detailed are applicable unless otherwise notified by the Ministry of Finance.

### **3.3.6 Preparation of non-development (temporary) budget**

3.3.6.1 Temporary budget estimates, as defined in Direction 3.2.2.3, shall only be included in this section of the budget where already agreed with Finance Division/ Department. No scheme of fresh items can be included in the Budget unless it is complete and approved.

3.3.6.2 The requirements for preparation of revised estimates and excesses and surrenders as given in Directions 3.3.5.3 to 3.3.5.5 also apply to temporary budgets.

3.3.6.3 Temporary budget estimates must be submitted by spending entities to their respective ministries for examination no later than *1 November* each year. Where clearance of fresh charge proposals is required by other ministries or departments, it should be obtained prior to submission .

3.3.6.4 Temporary budget estimates must be submitted to the Financial Advisor no later than *1 December* each year. Subsequently the budget orders pertaining to the temporary (Part II) budget must be submitted to the Budget Wing of Finance Division/ Department with a copy to the Accountant General no later than *1 February*.

3.3.6.5 The comparative analysis of revised estimates with sanctioned grants and budget estimates for the current year and next year provided for in Direction 3.3.5.7, should also be submitted.

3.3.6.6 The dates detailed are applicable unless otherwise notified by the Ministry of Finance.

### **3.3.7 Preparation of development budget**

3.3.7.1 Detailed procedures for the preparation, appraisal and approval of development project proposals are set out in the 'Manual for Development Projects' issued by the Planning Commission and are applicable to all spending entities. Development project estimates must only be prepared for projects approved in accordance with those procedures.

3.3.7.2 When spending entities submit their proposals to the Planning Commission for the Annual Development Programme, a copy of this submission must be forwarded to the respective Financial Advisor. This will include detailed estimates for individual projects.

---

3.3.7.3 Estimates of development expenditure for each project/scheme must be furnished by spending entities to the Financial Advisor no later than *1 December* each year. The following information for each project/scheme must be provided:

- name of project/scheme
- expected date of completion
- physical targets to be achieved in the project
- accumulated expenditure and percentage of completion up to the end of the previous year
- revised budget estimate and physical targets for the current financial year
- budget estimate for next financial year
- targets proposed for next financial year and basis for determining target.

3.3.7.4 The level at which development project budgets will be submitted is as follows:

- development grant and scheme (project) within each grant
- at detailed function and object level for those heads pertaining to project expenditures within each primary unit of appropriation.

3.3.7.5 Spending entities shall provide details of physical targets to be achieved by the project, along with budget estimates.

3.3.7.6 If a project is new, and a budget estimate is submitted for the first time, it should be accompanied by copies of the relevant PCI and PCII (project definition and feasibility) forms.

3.3.7.7 Proposals submitted to Works Division/Department for works expenditure to be incurred under a development project, shall be compiled by Works Division/Department on a project-wise basis and submitted to Finance Division/ Department.

3.3.7.8 Spending entities must ensure that there is no overlap of budgets between individual development projects or between development and non-development expenditures.

3.3.7.9 The local currency component of the development project estimate must be shown separately from the foreign currency component. In addition, these components of the development project budget are not interchangeable throughout any stage of the project.

3.3.7.10 In relation to the estimate of foreign aid for a project, the following rules shall apply:

- 
- all foreign aid, in both loans and grants, shall be incorporated into estimates of development projects. Such estimates of foreign aid must first be cleared by the Economic Affairs Division
  - the foreign currency component of a development project estimate must be shown distinctly with the source and type of aid (e.g. Foreign aid, loan or grant). This information shall be provided in a separate statement to the Financial Advisor
  - foreign aid in the form of commodity assistance, where it is utilised under a development project, shall be provided for in the local currency component of the project estimate
  - the estimated Rupee equivalent of foreign currency loans to be repaid, shall be retained by the Ministry of Finance to cover such payments. This is referred to as 'Rupee cover'.

3.3.7.11 Once satisfied with these estimates, the Financial Advisor must obtain approval from the Principal Accounting Officer, who will sign off the budgets.

3.3.7.12 Subsequently the estimates of development expenditure must be submitted to the Budget Wing of the Finance Division/ Department, in the form of a New Item Statement, no later than *17 December* each year. The new item statement, countersigned by the delegated technical authority in the Planning Commission, should include distinct information for the foreign currency component of each development project as to its source and type of aid (i.e. foreign aid, loan or grant). This information should be shown in the budget book.

3.3.7.13 After submission to the Finance Division/ Department, a number of review processes must be initiated to establish the available resources for development expenditure and examine demands of individual projects. The review of each project must be made in light of the following factors:

- overall resource position (resources available from the Budget to finance the Annual Development Program)
- sectoral priorities
- phasing of projects
- status of projects
- availability of foreign aid
- likelihood of completion in the forthcoming financial year

3.3.7.14 The Federal Public Sector Annual Development Program, consisting of scheme-wise budget allocation, by sector, to each Ministry must be prepared by the Inter-Ministerial Priorities

Committee. This is then submitted to the Annual Plan Co-ordination Committee for review and final approval by the National Economic Council. This document incorporates provincial program and provincial foreign aid requirements and forms the basis for the compilation of the development portion of the Federal Budget.

### **3.3.8 Preparation of receipt estimates**

- 3.3.8.1 Estimates of receipts must be prepared by those authorities responsible for administering revenues. Preliminary revenue estimates must be submitted to the Financial Advisor for scrutiny and forwarded to the Budget Wing of Finance Division/ Department no later than *1 December* each year. This enables the overall resource position to be determined for financing of the Public Sector Development Program. Final estimates, with explanatory notes, shall be received by *1 March* each year.
- 3.3.8.2 The authorities required to submit receipt estimates are the Central Board of Revenue and the respective Excise and Taxation Departments for direct and indirect tax receipts, Economic Affairs Division for foreign aid receipts and administrative ministries and departments for other receipts.

### **3.3.9 Consolidation of budget data**

- 3.3.9.1 After budget estimates have been reviewed by the Financial Advisor and approved by the Principal Accounting Officer, the demands for grants pertaining to that ministry or department must be prepared and submitted, (along with the supporting Budget Orders and New Item Statements) to the Budget Wing of the Finance Division/Department.
- 3.3.9.2 The Finance Division/Department shall review and consolidate the demands for grants submitted by the respective ministries and departments. Where in place, computerised budget management systems should be used to capture, verify and consolidate the budget data.
- 3.3.9.3 The Finance Division/Department must review the consolidated estimates to ensure the overall budget policy and objectives have been met, and make adjustments in consultation with ministries and departments where required.
- 3.3.9.4 Upon completion of the consolidation and review process the final budget documents will be produced, for tabling before the National/Provincial Assembly.

### **3.3.10 Authorisation**

- 3.3.10.1 Budgets approved in procedures as detailed earlier must subsequently be tabled before the National/Provincial Assembly for authorisation.
- 3.3.10.2 Authorised budgets must be recorded in the Schedule of Authorised Expenditure, with subsidiary information contained in the Details of Demands for Grants and Appropriations annual publication (current and development expenditure).

### **3.3.11 Implementation**

- 3.3.11.1 After the budget is passed by the legislature, together with sums tabled for charged expenditure, the Finance Division/Department must formally communicate the budgets, as set out in the Schedule of Authorised Expenditure, to each ministry and to the respective Accountant Generals.
- 3.3.11.2 A separate release letter must be sent by the Finance Division/Department to the spending ministries and departments, with copies to the respective Accountant Generals, to advise on the funds made available against these budgets. The Accountant Generals must communicate this information to the District Accounts Offices.



---

3.3.11.3 An appropriation ledger must be maintained by the Finance Division/Department to record the initial distributions of budgets made to spending entities and any subsequent adjustments made throughout the year.

3.3.11.4 It is the responsibility of the Principal Accounting Officer to ensure the budgets applicable to his/her spending entity are properly communicated to the various delegated officers in that entity. The Principal Accounting Officer will maintain a record of such distributions.

### **3.3.12 Reporting and monitoring**

3.3.12.1 The Principal Accounting Officer of each spending entity is responsible for controlling expenditure from the grants available and will exercise this control through his/her delegated authorities.

3.3.12.2 At a transaction level, Drawing and Disbursing Officers must ensure claims for payment are properly prepared and duly approved, as per the Schedule of Authorised Expenditure, classified, and recorded according to the rules procedures for expenditures laid down in chapter 4 of this Manual.

3.3.12.3 No transaction exceeding the value of available funds can be passed for payment. However, if the claim is inevitably payable under legal contracts and insufficient funds exist, the demand for payment may be honoured. The disbursing officer must report the matter to a delegated authority before approving the claim (Direction 3.3.12.7). In such circumstances the Principal Accounting Officer must take appropriate actions to find the extra funds for such payments.

3.3.12.4 Any spending entity required to undertake work or incur expenditure on behalf of another is required to exercise proper budgetary control over the funds provided by the principal authority. The entity incurring the expenditure must ensure:

- the funds provided by the principal entity are not exceeded
- the money is spent for the purpose intended
- any anticipated savings are promptly surrendered back to the principal entity.

The principal entity will communicate the grant within which expenditure may be incurred to the concerned spending entity and issue the required approval for expenditure to be incurred by a nominated authority in that entity.

3.3.12.5 The Principal Accounting Officer in each spending entity, as part of his/her responsibility for monitoring expenditures, must submit a

---

statement of excesses and surrenders to the Finance Division/Department at prescribed dates, and in a format set down by the Finance Division/Department.

3.3.12.6 All anticipated savings must be surrendered to the Government immediately as they are foreseen, but no later than 15th May each year. Savings from funds provided after 15th May must be surrendered no later than *30 June*. Stringent controls should be exercised in the spending of all potential or actual savings. In addition:

- no savings should be held in reserve for possible future excesses
- expenditure postponed must not be re-allocated to meet new items of expenditure
- expenditure must not be incurred simply because funds may be available within a particular grant. Grants that cannot be properly utilised must be surrendered.

3.3.12.7 Excesses (i.e. expenditure for which no provision has been made in the current year's original budget) should not normally be incurred. However, in certain cases where budgetary factors have changed abnormally or have been under-estimated (such as growth rates and inflation) it is possible for the Principal Accounting Officer to re-allocate funds, provided they are available from savings arising in the same grant. In this case the Principal Accounting Officer or his/her delegated officer is permitted to re-allocate funds between the individual allotments made to delegated officers or between detailed object heads of the same primary unit of appropriation within a particular grant, provided the:

- re-allocation is not to or from the establishment (salaries and allowances) budget
- delegated authority is also an authority competent to approve expenditure under these heads
- re-allocation is authorised before the expiry of the financial year to which the budget relates
- amount re-allocated does not exceed any financial limits as determined by the Finance Division/ Department.

3.3.12.8 Re-allocation between primary units (major object) of appropriation and between different grants must be approved by the Finance Division/Department. The specific authorities for such transfers are set out in the 'Delegation of Financial Powers' issued by the Federal Government and each of the Provincial Governments.

3.3.12.9 The Principal Accounting Officer is not permitted to re-allocate funds between major and minor function heads within the entity.

---

3.3.12.10 In all cases of funds re-allocation, the Accountant General's office must be immediately informed once it has taken place.

3.3.12.11 Re-allocation of funds between voted and charged components of the Budget is not permitted.

### **3.3.13 Supplementary Grants**

3.3.13.1 If funds are still not available within the grants available to the spending entity, it should then consider whether the expenditure can be postponed. If it cannot be postponed, the spending entity can then apply to the Finance Division/Department for a Supplementary Grant.

3.3.13.2 A submission to the Finance Division/Department for a Supplementary Grant will not be accepted unless the excess is due to a cause beyond the control of the spending entity concerned and expenditure cannot be legitimately postponed.

3.3.13.3 Expenditure on new services or programs in which no provision in the budget has been made will not normally be admitted as a Supplementary Grant and should be met from savings.

3.3.13.4 The Finance Division/Department will need to give their consent for the Supplementary Grant application. However, the Supplementary Grant application can only be approved by the National Assembly/Provincial Assembly during the budgetary cycle for the following year. Expenditure during the interim period in respect of the additional appropriation applied for through the Supplementary Grant application commencing from the MoF/FD's consent to the approval by the National Assembly / Provincial Assembly will be governed by MoF/FD circulation and standing orders issued from time to time.

### **3.3.14 Review**

3.3.14.1 An annual statement of expenditures against budget (appropriation), referred to as the Annual Appropriation Accounts, is prepared and published by the Accountant General Pakistan Revenues and respective provincial Accountant Generals. All the self-accounting entities prepare and publish their own Annual Appropriation Accounts, duly certified by the DGs of Audit.

3.3.14.2 This report must provide, for the whole financial year just completed:

- a comparison of actual expenditure with original and supplementary budget.

- details of excesses and surrenders and supporting explanatory notes (as provided by spending divisions and departments)
- comparison of actual expenditure with previous year actual.

This information will be provided for each grant, down to minor function and object level.

3.3.14.3 The review process also includes the auditing function, which may be both external (i.e. by the Auditor General's Department) and internal (by the ministry or department itself). Internal review processes may assess performance against budget, and achievement of planning objectives against financial and non-financial performance measures.

3.3.14.4 The Public Accounts Committee should investigate those cases in which a ministry or department has incurred a material deviation from budget and make recommendations to the National/Provincial Assembly. The National/Provincial Assembly approve the material deviations from budget recommended by the Public Accounts Committee (excess expenditures) and publish the approval in the form of an Excess Budget Statement.

3.3.14.5 Information and feedback obtained from the above review processes will be used in developing next years budget, thus completing the budgetary cycle (Direction 3.3.5.3).

---

### **3.4 Specific Budgetary Procedures**

#### **3.4.1 Introduction**

3.4.1.1 This section discusses specific aspects of the budgeting process that need to be considered in addition to the Detailed Procedures set out in the previous section.

#### **3.4.2 Charged Expenditures**

3.4.2.1 Article 81 of the Constitution sets out those items which are to be charged upon the Federal Consolidated Fund. Similarly, Article 121 of the Constitution sets out related items to be charged upon the Provincial Consolidated Fund and is broadly in line with the above. These items are:

- the remuneration payable to the President and other expenditure relating to his office
- remuneration payable to the Judges of the Supreme Court, the Chief Election Commissioner, the Chairman and Deputy Chairman, the Speaker and Deputy Speaker of the National Assembly and the Auditor General
- the administrative expenses of the above offices
- all debt charges for which the Federal Government is liable including interest, repayment of capital and other expenditure connected with the raising of loans, and the servicing and redemption of debt on the security of the Federal Consolidated Fund
- any sums required to satisfy any judgements, decrees or awards against Pakistan by any court
- any other sums declared by the Constitution or by Act of Parliament to be so charged (e.g. Wafaqi Mohtasib).

#### **3.4.3 Centrally provided for expenditures**

3.4.3.1 The following expenditures shall be centrally provided for by the Accountant General under instructions issued by the Government. These estimates are to be submitted to the Finance Division/Department by the prescribed date for inclusion in the Annual Budget Statement:

- expenditure on pensions
- GP fund expenditures
- loans and advances

- interest on miscellaneous debts.

# 4 Expenditures

---

## Table of Contents

<b>4.1</b>	<b>Introduction</b>	<b>4.5</b>
<b>4.2</b>	<b>General Policies</b>	<b>4.6</b>
4.2.1	Overview	4.6
4.2.2	Sanction of expenditure	4.6
4.2.3	Budget availability review function	4.7
4.2.4	Purchase order function	4.7
4.2.5	Voucher preparation for claims above the specified limit	4.7
4.2.6	Approval of expenditure	4.7
4.2.7	Certification (pre-audit) of expenditure	4.8
4.2.8	Authorisation of payment	4.8
4.2.9	Issue of payment	4.9
4.2.10	Use of imprest account - for expenditures below the specified limit	4.10
4.2.11	Payment from banks and post office	4.10
4.2.12	Stop payment and replacement cheque	4.11
4.2.13	Unclaimed and stale cheques	4.11
4.2.14	Arrears claims	4.11
4.2.15	Payment for supplies in advance	4.11
<b>4.3</b>	<b>Accounting Policies</b>	<b>4.13</b>
4.3.1	Mode of payment	4.13
4.3.2	Recognition of expenditure	4.13
4.3.3	Commitment accounting	4.13
4.3.4	Validity period for issued cheques	4.15
4.3.5	Deductions against payment	4.15
4.3.6	Currency	4.15
4.3.7	Setting-off of expenditures and receipts	4.15
4.3.8	Refunds paid	4.15
4.3.9	Summary of accounting policies	4.16
<b>4.4</b>	<b>Accounting for Expenditures</b>	<b>4.17</b>
4.4.1	Budget and commitment accounting records	4.17
4.4.2	Recording of expenditure (Appropriation Control Register)	4.17
4.4.3	Summary of entries to Appropriation Control Register	4.18
4.4.4	Manual accounting records	4.19
4.4.5	Computerised accounting records	4.20
4.4.6	Accounting entries for expenditure (General Ledger)	4.20
<b>4.5</b>	<b>Detailed Procedures</b>	<b>4.23</b>
4.5.1	Introduction	4.23
4.5.2	Expenditure processing flowchart	4.24
4.5.3	Voucher preparation for claims above the specified limit	4.25
4.5.4	Approval of expenditure	4.26
4.5.5	Registration of purchase order/claim voucher	4.27
4.5.6	Certification (pre-audit) of expenditure	4.28
4.5.7	Authorisation of payment	4.30
4.5.8	Preparation and dispatch of cheques	4.30
4.5.9	Expenditure payments below the specified limit	4.31
4.5.10	Timing and priority of the claim	4.32
4.5.11	Stop payment and replacement cheque	4.32
4.5.12	Unclaimed and stale cheques	4.32
4.5.13	Daily Advice Note to bank	4.33
4.5.14	Recording, consolidation and reporting of expenditure flowchart	4.34

---



4.5.15	Recording of expenditures	4.35
4.5.16	Consolidation of expenditures	4.35
4.5.17	Reporting of expenditures	4.35
4.5.18	Reconciliation of expenditures	4.35
<b>4.6</b>	<b>Salaries and Wages</b>	<b>4.37</b>
4.6.1	Introduction	4.37
4.6.2	Due date	4.37
4.6.3	Payment by direct credit	4.37
4.6.4	Payment by cheque	4.38
4.6.5	Deductions from salaries and wages	4.38
4.6.6	Transfers of employees to other departments/entities	4.38
4.6.7	Deputation	4.39
4.6.8	Final payment	4.39
4.6.9	Payment of sums due at death	4.39
4.6.10	Leave Payment	4.40
4.6.11	Payroll processing flowchart	4.41
4.6.12	Payroll processing	4.42
4.6.13	Payment in cash to employee below grade V	4.44
4.6.14	Recording of payroll expenditure	4.44
4.6.15	Consolidation of payroll expenditure	4.45
4.6.16	Reporting of payroll expenditure	4.45
4.6.17	Recording, consolidation and reporting of payroll expenditure flowchart	4.46
4.6.18	Reconciliation of payroll expenditure	4.46
<b>4.7</b>	<b>Pension Payments</b>	<b>4.47</b>
4.7.1	Introduction	4.47
4.7.2	Due date	4.47
4.7.3	Payment by direct credit	4.47
4.7.4	Payment by cheque	4.48
4.7.5	Pension Payment Order (Pension Book)	4.48
4.7.6	Personal appearance of pensioner	4.49
4.7.7	Overseas pension payment	4.49
4.7.8	Gratuities	4.49
4.7.9	Undrawn pensions and arrears	4.50
4.7.10	Death of pensioner	4.50
4.7.11	Processing of pension application flowchart	4.51
4.7.12	Processing of pension application	4.52
4.7.13	Processing of pension payment flowchart	4.54
4.7.14	Processing of pension payment	4.55
4.7.15	Recording of pension expenditure	4.56
4.7.16	Consolidation of pension expenditure	4.56
4.7.17	Reporting of pension expenditure	4.56
4.7.18	Recording, consolidation and reporting of pension expenditure flowchart	4.56
4.7.19	Reconciliation of pension expenditure	4.57
4.7.20	Reporting on pensions	4.57
<b>4.8</b>	<b>General Provident Fund</b>	<b>4.58</b>
4.8.1	Introduction	4.58
4.8.2	Advance from GP Fund	4.58
4.8.3	Payment by direct credit	4.59
4.8.4	GP Fund monthly deductions from salary	4.59
4.8.5	Processing of GP Fund payment flowchart	4.60
4.8.6	Processing of GP Fund payment	4.61
4.8.7	Recording of GP Fund expenditure	4.63
4.8.8	Consolidation of GP Fund expenditure	4.63
4.8.9	Reporting of GP Fund expenditure	4.63
4.8.10	Recording, consolidation and reporting of GP Fund expenditure flowchart	4.64

---

4.8.11	Reconciliation of GP Fund expenditure	4.64
<b>4.9</b>	<b>Contractor/Work Payments</b>	<b>4.65</b>
4.9.1	Introduction	4.65
4.9.2	Work done for other departments	4.66
4.9.3	Processing of payment to supplier and contractors flowchart	4.67
4.9.4	Processing of payment to supplier and contractors	4.68
4.9.5	Payments for works done through Local Bodies	4.71
4.9.6	Recording of contractors expenditure	4.71
4.9.7	Consolidation of contractors expenditure	4.71
4.9.8	Reporting of contractors expenditure	4.71
4.9.9	Recording, consolidation and reporting of contractors expenditure flowchart	4.72
4.9.10	Reconciliation of contractors expenditure	4.72
<b>4.10</b>	<b>Loans And Advances</b>	<b>4.73</b>
4.10.1	Introduction	4.73
4.10.2	Loan and advances to Provincial Governments	4.73
4.10.3	Loans and advances to Government employees	4.73
4.10.4	Housing advances to Government employees	4.74
4.10.5	Vehicle advances to Government employees	4.76
4.10.6	Bicycle advances to Government employees	4.77
4.10.7	Interest free advances to Government employees	4.77
4.10.8	Permanent advances	4.78
4.10.9	Recording of loans and advances	4.78
4.10.10	Consolidation of loans and advances	4.78
4.10.11	Reporting of loans and advances	4.79
<b>4.11</b>	<b>Overseas Payments</b>	<b>4.80</b>
4.11.1	Introduction	4.80
<b>4.12</b>	<b>Grants-in-aid, Contributions etc.</b>	<b>4.81</b>
4.12.1	Introduction	4.81
4.12.2	Accounting Entries	4.82
<b>4.13</b>	<b>Assignment Account and Personal Ledger Account</b>	<b>4.83</b>
<b>4.14</b>	<b>Maintenance of Permanent Accounting Records</b>	<b>4.84</b>
4.14.1	Introduction	4.84
4.14.2	Establishment Register	4.84
4.14.3	Payroll Register	4.85
4.14.4	Pension Register	4.86
4.14.5	GP Fund Ledger	4.87
4.14.6	Commitment accounting records	4.89
4.14.7	Recording of expenditure (General Ledger)	4.89
4.14.8	Budget/funds control entries	4.91

---

---

## 4.1 Introduction

- 4.1.1.1 This chapter describes the policies, accounting treatment and procedures to be applied for expenditures, and all stages of expenditure processing. The chapter also includes procedures for specific types of expenditure.
- 4.1.1.2 The policies include both general policies and accounting policies which apply to all forms of expenditure and payment processes.
- 4.1.1.3 The accounting treatment details the records which need to be maintained for complete and accurate recording of expenditures and the appropriate double entries for recording the transactions in the general ledger.
- 4.1.1.4 Based on these policies, the Detailed Procedures for expenditure transactions are then set out.
- 4.1.1.5 More detailed policy and procedures for the following types of expenditure are then provided:
- salaries and wages
  - pensions
  - GP fund
  - contractor/works payments
  - loans and advances
  - grants-in-aid and contributions.
- 4.1.1.6 The final section of the chapter addresses the maintenance of permanent accounting records, required to correctly make salary and other employee related payments.
- 4.1.1.7 This chapter cover expenditures relating to the Consolidated Fund only. Expenditures relating to fixed assets and Public Account are covered in chapters 13 and 14 of the APPM, respectively.
- 4.1.1.8 This chapter does not cover non-accounting procedures or regulations. Also, detailed personnel and financial procedures are not covered here, as they are currently provided under the relevant Rules and Standing Orders, ESTA Codes, Civil Establishment Code and Fundamental and Supplementary Rules, issued by the Establishment/Finance Division from time to time.
- 4.1.1.9 All source documents and accounting records prepared in DDO, DAO, AG/AGPR office and specified in this chapter are to be recorded (written) in English.

## **4.2 General Policies**

### **4.2.1 Overview**

4.2.1.1 'Expenditure' is a term commonly used to describe the consumption of economic resources within an entity. As set out in the Manual of Accounting Principles, expenditure will be accounted for on a cash or as committed basis.

4.2.1.2 The following key steps are required to be followed in all expenditure transactions:

- sanction of expenditure
- preparation of claim voucher (bill) for payment (except for salaries and wages)
- approval of expenditure
- registration of purchase order/claim voucher
- certification (pre-audit) of claims
- authorisation of payment
- issue of payment
- recording of expenditure in the accounting records.

### **4.2.2 Sanction of expenditure**

4.2.2.1 Every expenditure must be sanctioned by an officer of the Government who has the authority to approve proposals to incur expenditures (including enter into commitments) on behalf of the Government and who shall be deemed to be the Sanctioning Officer. The Sanctioning Officer's authorities are set out in the "Delegation of Financial Power under the Financial Rules" issued by the Ministry of Finance/Finance Department.

4.2.2.2 Officers holding authority to approve expenditure proposals must be held responsible for the exercise of due care and diligence, and should not incur expenditure (or enter into commitment) in excess of the amount appropriated by the National or Provincial Assembly.

4.2.2.3 The sanction process comprises two functions; namely a Budget Availability Review and the raising of a Purchase Order. The Budget Availability Review will be performed for all expenditures, whereas Purchase Orders will be raised for contingent expenditures only.

---

### **4.2.3 Budget availability review function**

4.2.3.1 The budget availability review function involves assessing whether the expenditure or commitment entered into:

- is provided in the Schedule of Authorised Expenditure
- is provided for in a Supplementary Grant.

4.2.3.2 A budget availability review clearance form (form 4AA) will be prepared following this function and approved by an officer who has the authority to incur the expenditure.

### **4.2.4 Purchase order function**

4.2.4.1 A sequentially numbered purchase order (form 4A) shall be raised for all contingent expenditures (excluding salaries and utilities etc.) by the department/entity.

4.2.4.2 Purchase orders shall be approved by the officer who has authority to incur expenditure.

4.2.4.3 The budget availability review clearance form and purchase order (where applicable) will represent the sanction for the expenditure and must be sent to the relevant DAO/AG/AGPR office.

### **4.2.5 Voucher preparation for claims above the specified limit**

4.2.5.1 A prescribed claim voucher form (bill) (form 4B) must be prepared by the incurring officer for supplies, services rendered and work done under a contract or other arrangement over the specified limit.

4.2.5.2 A duplicate claim voucher must not be issued except where the original has been lost or destroyed. Also refer to FTR 145 (chapter I of Part V) for detailed instructions on this matter.

4.2.5.3 Travelling expense claims should be accompanied by all prescribed receipts. Travelling claims should be submitted within one month of the completion of journey.

### **4.2.6 Approval of expenditure**

4.2.6.1 Every claim voucher (bill) must be approved by an officer (other than the sanctioning officer and who shall be different from the DDO) within the entity incurring the expenditure, in accordance with procedures set out in section 4.5.4. The approving officer will be held personally responsible for the correctness of all claim vouchers bearing his/her signature.

---

4.2.6.2 The approving officer must ensure that for the expenditure being claimed, an approved purchase order (where applicable) was previously raised and a copy is attached to the claim voucher.

#### **4.2.7 Certification (pre -audit) of expenditure**

4.2.7.1 Every claim voucher (bill) must be certified by an officer in the relevant District Account Office/Accountant General Office/Accountant General Pakistan Revenue Office and who shall be deemed to be the certifying officer.

4.2.7.2 The certification (pre-audit) process comprises two functions; namely a verification function and an audit function. For claims above a certain threshold, as set by the Ministry of Finance/Auditor-General, both functions of the certification process shall be carried out. Conversely for claims below the set threshold, only the verification function will need to be performed.

4.2.7.3 The verification function involves:

- the certifying officer ensuring that the claim voucher has been duly approved by a delegated approving officer in the entity
- the certifying officer verifying the validity of the claim voucher, in accordance with procedures set out in section 4.5.5, and ensure it correctly identifies the account head to which payment will be charged
- the certifying officer initially checking that the funds are available to make the relevant payment.

4.2.7.4 The audit function involves:

- scrutinising of the claim voucher to identify possible fraud and irregularities that a reasonable person would be expected to discover.

#### **4.2.8 Authorisation of payment**

4.2.8.1 Once certified (pre-audited), the claim voucher (bill) may then be authorised for payment, by an officer in the District Account office/Accountant General office/Accountant General Pakistan Revenue office and who shall be deemed to be the certifying officer.

4.2.8.2 The authorising officer must not authorise a claim unless it has been duly certified and sufficient funds are available in the concerned budget head to make the payment.

---

4.2.8.3 The authorising officer must not authorise those claim vouchers which do not relate to his/her district office or, for which a written direction has not been received from the Accountant General.

4.2.8.4 The functions of the certifying officer and the authorising officer can not be performed by the same person unless approved by the Auditor-General.

#### **4.2.9 Issue of payment**

4.2.9.1 Payment must only be made for those claims that have been duly approved, certified and authorised.

4.2.9.2 All expenditures must be classified in accordance with the Chart of Account, under the appropriate expenditure head.

4.2.9.3 No transaction exceeding the value of available funds can be passed for payment. However, if the claim is inevitably payable under legal contracts and insufficient funds exist, the demand for payment may be honoured. The authorising officer must report the matter to a delegated authority before approving the claim. In such circumstances the Principal Accounting Officer must take appropriate actions to find the extra funds for such payments.

4.2.9.4 Payment of approved claims must be made only to the claimant as indicated on the claim voucher.

4.2.9.5 Only Government cheque books should be used when making payments by cheque.

4.2.9.6 All cheques must be signed by two delegated officers. The cheque signing officers should be independent of officers involved in voucher certification, voucher authorisation and cheque preparation, unless in the exceptional circumstances where the relevant DAO office is small, as approved by the Accountant General. Where the cheque amount is below a threshold (as defined by the Auditor General), the Accountant General can relax the provision and authorise only one delegated officer to sign the cheque.

4.2.9.7 Every officer authorised to draw cheques or sign or countersign cheques, must send a specimen of his/her signature to the designated bank branch through the Accountant General (or his delegated officer) whose specimen signature is already with that bank branch. This officer must countersign the signature of the new officer. When such an officer gives his/her charge to another officer, he/she must likewise send a specimen of the signature of the relieving officer to the bank.

---

4.2.9.8 When an authorised cheque signatory vacates his/her position, the next higher officer must immediately advise the designated bank branch and the Accountant General.

4.2.9.9 Cheque payments should be released to the payee or personally collected by the payee or his authorised agent. Cheque payments made by registered post should have cheque envelopes bearing a direction to return the unclaimed cheque (i.e. unclaimed post) to the issuing department.

#### **4.2.10 Use of imprest account - for expenditures below the specified limit**

4.2.10.1 All expenditures below the specified limit (as advised by the MoF) should be made through an imprest account (petty cash account). A petty cash book must be maintained by a delegated officer (Drawing and Disbursing Officer) in the entity responsible for the petty cash account.

4.2.10.2 Each entity should maintain an imprest account by drawing a cheque in the name of the respective DDO each month, of the amount required to re-establish the original imprest (in accordance with GFR 132).

4.2.10.3 Original vouchers above Rs. 200 must be produced to support the claim for reimbursement. The Ministry of Finance, in consultation with the Principal Accounting Officer (PAO) of the entity should set the limit of the imprest so that it requires reimbursement at least once a month, having due regard to the size of the department and the percentage of the imprest limit required to be spent before a reimbursement claim can be submitted.

4.2.10.4 During the month, petty cash payments will be made out of this imprest account, against valid petty cash vouchers submitted to the DDO.

4.2.10.5 This account must always balance at any point in time i.e. totals of all valid petty cash vouchers plus amount left in the imprest account should equal the value of the original imprest float.

#### **4.2.11 Payment from banks and post office**

4.2.11.1 Only the State Bank of Pakistan (SBP) and the National Bank of Pakistan (NBP) acting as its agent, will be the official bank from which payments will be made.

4.2.11.2 No payment should be paid through post offices (post-bank) except pension payment where authorised by the Federal/Provincial Government.



---

**4.2.12 Stop payment and replacement cheque**

4.2.12.1 A stop payment notice is a specific direction given by the cheque signatory officer to the bank on which that cheque was drawn requiring it to refuse to pay the cheque when presented. This mechanism may be used to protect the interests of both the Government and the payee; for example, where a cheque is not received by the payee, or is lost or stolen.

4.2.12.2 A replacement cheque will only be issued to the concerned payee if the original cheque has been stopped by the cheque signatory officer (by giving stop payment notice to the bank) and the bank's written acknowledgement has been obtained.

**4.2.13 Unclaimed and stale cheques**

4.2.13.1 If a cheque has not been claimed or has not been presented and paid within the valid period (as advised by the MoF), it is stale and may not be negotiated.

4.2.13.2 A new cheque shall only be issued when the stale cheque is returned (deposited) by the payee of the cheque to the concerned DAO/AG/AGPR. The old cheque shall be marked 'cancelled' and a new cheque shall be issued in accordance with section 4.2.9.

4.2.13.3 After the validity period has expired, the amount must be transferred into an "unclaimed money account" within the Public Account. Such unclaimed amount will be cleared after three years and transferred to the Consolidated Fund.

**4.2.14 Arrears claims**

4.2.14.1 Only those claims against the government raised within six months of their becoming due can be presented without prior authority from the Accountant General. This rule does not apply to payments of claims on account of pensions (see Section 4.7.9), nor to payments of interest on government securities or any other type of payments which are governed by special rules or orders by the Government.

4.2.14.2 Claims of government employees to arrears of pay or allowances shall be dealt in accordance with rules given in the General Financial Rules (GFR).

**4.2.15 Payment for supplies in advance**

4.2.15.1 Payment must not be made in advance unless it is required by the agreement with the supplier and supported by a bank guarantee for the

---

value of the advance. An agreement of that type must not be entered into merely to avoid the lapsing of an appropriation.

4.2.15.2 Officers should ensure that before agreeing to make an advance payment or enter into a interim payment arrangement, approval from an officer, as specified by the Delegation of Financial Powers, is obtained.

4.2.15.3 Where an advance payment is made, the entity should ensure that adequate steps are taken to protect the public money. The intended purpose of the advance payment should be stipulated clearly in the contract.

### **4.3 Accounting Policies**

#### **4.3.1 Mode of payment**

4.3.1.1 All expenditures apart from the following and those met from imprest account will be paid through cheque:

- inter-government transfers (see Chapter 12)
- certain salaries payments (see Section 4.6)
- certain pension payments (see Section 4.7)
- GP Fund payments (see Section 4.8).

#### **4.3.2 Recognition of expenditure**

4.3.2.1 Where payment is made by cheque, expenditure will be recognised and recorded in accounts of the Government on the date the cheque is issued.

4.3.2.2 In the case of inter-government transfers, expenditure will be recognised on the date the transfer is made by the transferor.

4.3.2.3 For direct payments into a Government employee's bank account, expenditure will be recognised on the date the payment advice is issued by the DAO/AG/AGPR office to the bank.

4.3.2.4 For repayment of loans and other direct payments by the SBP, expenditure will be recognised on the date advised by the SBP to the AG/AGPR office.

4.3.2.5 In the case of payments made from imprest monies, the expenditure will be recognised when the required claim vouchers are submitted and the imprest account reimbursed.

4.3.2.6 The financial year to which a payment should be charged is determined by the date on which a cheque or payment advice is issued.

#### **4.3.3 Commitment accounting**

4.3.3.1 To ensure the matching of expenditure against appropriations, the cash basis of accounting has been modified to recognise some items of expenditure on a commitment basis.

4.3.3.2 Commitments are used to control large and non-regular expenditures against appropriation, and need not be recorded for immaterial expenditure of a recurring nature. Commitments will be accounted for on a memorandum basis.

---

4.3.3.3 The following criteria shall be applied when determining and recognising a commitment:

- a valid purchase order is raised and, where applicable, a purchase contract (legal undertaking or legally binding) has been entered with the supplier. The amount involved should be clearly mentioned in the purchase order/contract
- the officer in accordance with the Delegation of Financial Powers (who shall be deemed to be the approving officer) has authorised the commitment
- the amount involved (expenditure) is above Rs 10,000 or 10% of total budget head, whichever is higher
- exclude the following types of payments:
  - salaries and related deductions
  - pension
  - GP fund
  - loans and advances to employees.

4.3.3.4 Once a commitment is entered into and approved by the delegated authority (approving officer), it must be recorded by the DDO.

4.3.3.5 Commitments shall only be raised for those expenditures expected to be paid for in the current financial year.

4.3.3.6 A commitment advice form (form 4C) must be completed by the DDO and after approval by the delegated authority (approving officer), the form shall be sent to the DAO/AG/AGPR office along with the relevant purchase order (which is in sequential order as set out in section 4.2.4). A copy of any contract/agreement shall also be sent with the commitment advice form.

4.3.3.7 Except as set out in direction 4.3.3.8, a commitment, once recorded, must not be reversed unless:

- payment has been made, or
- the purchase order or other legally binding contract has been cancelled and the same delegated authority entering into the commitment has approved the reversal.

4.3.3.8 At the close of the financial year all outstanding commitments made during that year are duly scrutinised by the AG/MoF and provision made in the next year's appropriation (through supplementary budget process, as set out in chapter 3) to allow for the reinstatement of valid commitments in the next financial year.

---

4.3.3.9 Commitments which are not renewed are cancelled.

#### **4.3.4 Validity period for issued cheques**

4.3.4.1 Once a cheque is issued it will only be valid for encashment within such a period as directed by the MoF. The validity period for issued cheques shall be consistent throughout Pakistan.

#### **4.3.5 Deductions against payment**

4.3.5.1 Deductions made against claim (e.g. withholding tax, security, adjustment of advances, penalties etc.) shall be carried out at the time of making the payment in accordance with amount as identified on the claim voucher and as per relevant rules.

#### **4.3.6 Currency**

4.3.6.1 All expenditures must be measured in Pakistani Rupees.

#### **4.3.7 Setting-off of expenditures and receipts**

4.3.7.1 No expenditure should be paid from or against any Consolidated Fund receipts collected or received by a department/entity, except where provided under the law.

4.3.7.2 Except as set out in section 4.3.8, all expenditures must be recorded on gross basis and shall not be wholly or partly offset with receipts.

#### **4.3.8 Refunds paid**

4.3.8.1 All refunds as a result of policy decision shall be treated as expenditure and shall only be paid against approved budget head. Where a refund is unplanned i.e. due to error or omission, it will be recorded as a reduction to the relevant receipt head.

4.3.8.2 Refunds paid for a receipt previously recognised in the current financial year will be adjusted to reflect the correct level of revenue, that is, as reduction in revenue. The appropriate 'refunds' account in the revenue section of the chart of accounts shall be used. The payment of refunds shall be in accordance with the procedures laid down in this Chapter.

4.3.8.3 If a refund paid relates to a prior financial year, it shall be recognised as an expense in the current financial year.

**4.3.9 Summary of accounting policies**

4.3.9.1 The following is a summary of the accounting policies in respect of the major categories of expenditure:

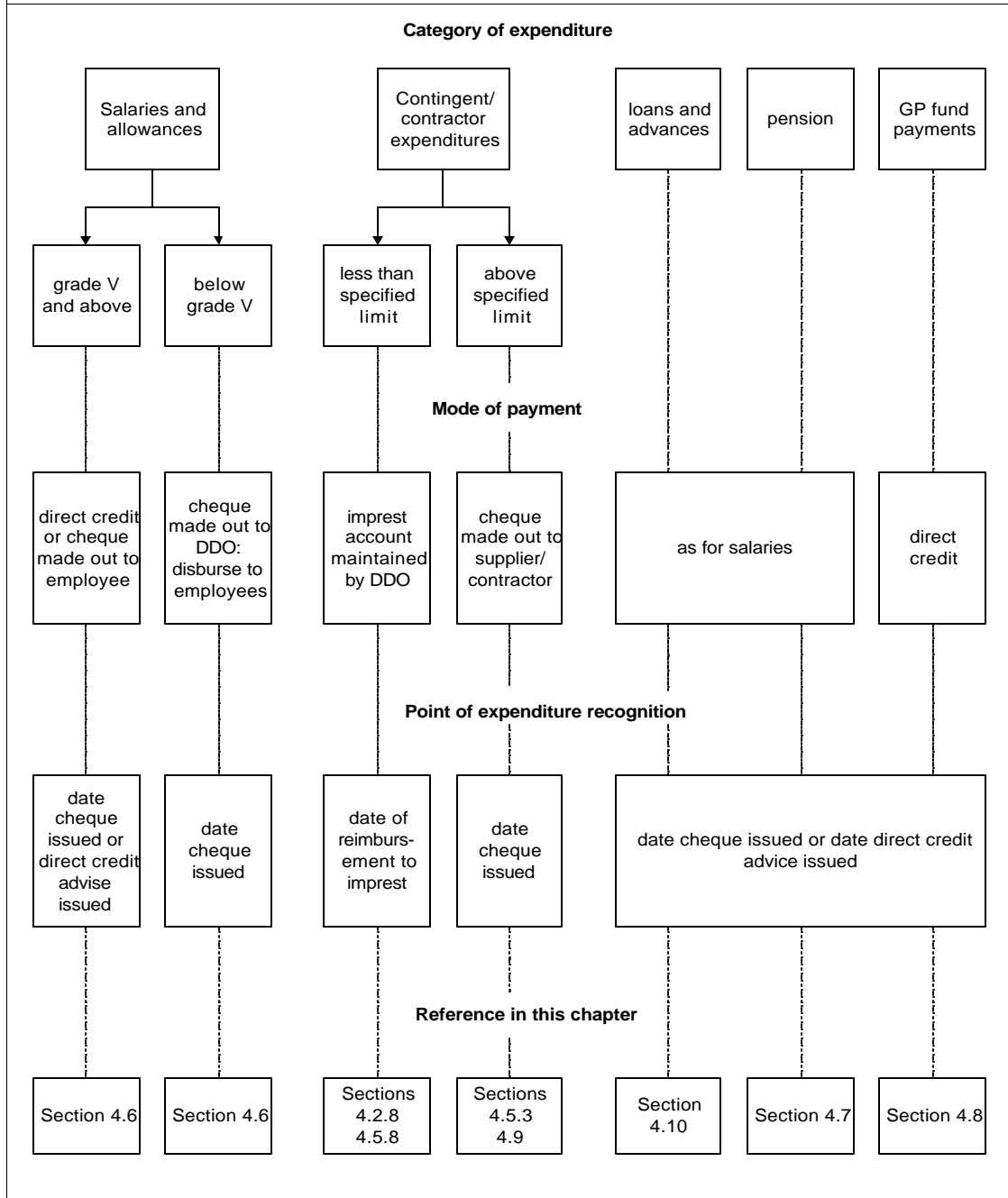

## 4.4 Accounting for Expenditures

### 4.4.1 Budget and commitment accounting records

4.4.1.1 **Appropriation Control Register** - A section to record commitments will be maintained within the Appropriation Control Register (form 4D) by the authorising officer in the DAO/AGPR/AG office. On receiving the commitment advice form from the DDO, the authorising officer must record the commitment in this register.

4.4.1.2 When the claim voucher relating to a commitment previously entered into by the department/entity is received by the authorising officer, he/she must reverse the original commitment entry in the commitment section of the Appropriation Control Register upon authorising payment.

### 4.4.2 Recording of expenditure (Appropriation Control Register)

4.4.2.1 Appropriation control is defined here as 'allocated budget less payments'. Whereas funds available is defined as 'allocated budget less payments and commitments'.

4.4.2.2 The following shall be recorded in relation to expenditure transactions within the Appropriation Control Register.

4.4.2.3 **Establishment of appropriation** - the following shall be carried out to record the appropriation against the relevant appropriation control within the Appropriation Control Register:

Update	Funds available ( - )
Update	Appropriation control ( - )

[to record the recognition of appropriation upon release by MoF]

4.4.2.4 **Expenditure with commitment** - The following shall be recorded, where a commitment is established:

Update	Funds available ( - )
Update	Commitment ( - )

[to record the setting up of commitment]

Update	Appropriation control ( - )
Update	Commitment ( - )

[to record the actual expenditure and reversing of commitment, upon issue of payment]

4.4.2.5 **Expenditure without commitment** - the following shall be recorded, where a commitment has not been established:

Update	Funds available ( - )
Update	Appropriation control ( - )

[to record the actual expenditure, upon issue of payment]

4.4.2.6 **Cancellation of issued payment** - where an issued payment has been stopped and cancelled, the following entry will be made in the Appropriation Control Register:

Update	Funds available ( - )
Update	Appropriation control ( - )

[to record re-establishment of available funds where cheque has been issued and subsequently cancelled]. If the cancelled payment related to a prior commitment, then the commitment should also be re-established as per the first entry shown in Direction 4.4.2.4.

4.4.2.7 **Cancellation of commitment at year end** - where a commitment is cancelled at the end of the financial year, the following entry will be made in the Appropriation Control Register:

Update	Funds available ( - )
Update	Appropriation control ( - )

[to record re-establishment of available funds where commitment has been cancelled].

#### 4.4.3 Summary of entries to Appropriation Control Register

	Appropriation Control	Commitment	Funds Available
1) <b>Establish funds</b>	-		-
2) <b>Enter commitment</b>		-	-
3) <b>Make payment (with commitment)</b>	-	-	



4) <b>Make payment (without commitment)</b>	-	-

#### 4.4.4 Manual accounting records

4.4.4.1 The following primary books of account must be maintained by the account section of the District Account office, the Accountant General office and the Accountant General Pakistan Revenue office.

4.4.4.2 **Sub Ledger** - Once a payment or related adjustment is made, each transaction shall be recorded in the "Sub Ledger" against account heads prescribed in the Chart of Accounts. The delegated officer must enter the following details in this Sub Ledger:

- date
- payment reference (e.g. cheque number)
- payment description
- account (as per Chart of Accounts)
- DDO reference
- amount in Rupees.

The delegated officer must total this Sub Ledger at the end of each day and post the daily totals, by account code, to the "General Ledger".

4.4.4.3 **Abstract** - In a manual accounting system, in order to obtain details from the Sub Ledger in an alternative order (e.g. expenditure by DDO, by account code) or to consolidate information for reporting purposes, it is necessary to prepare an abstract as a supplement to the Sub Ledger.

4.4.4.4 **General Ledger** - The General Ledger must record all expenditures and receipts on a daily totals basis. The daily totals of expenditure (by account code) from the Sub Ledger (in a manual accounting system via abstract) must be entered in this Ledger. Details must include:

- date
- account (as per Chart of Account)
- account description
- amount in Rupees.

---

#### 4.4.5 Computerised accounting records

4.4.5.1 In the computerised system the delegated officer in the account section of the District Account office or the Accountant General office must enter the claim and payment details into the computer system against the appropriate expenditure head code (account code), as set out in the Chart of Accounts.

#### 4.4.6 Accounting entries for expenditure (General Ledger)

4.4.6.1 The journal entries in this section will be made to record expenditure related transactions in the General Ledger (regardless of whether a commitment is established).

4.4.6.2 **Expenditure** - the following double entries will be made for expenditures:

Dr		Expenditure head account
	Cr	Cheque clearing account

[to record the amount charged to the relevant expenditure head. This entry shall be recorded in the General Ledger on the date the cheque is issued]

Dr		Cheque clearing account
	Cr	Bank account

[to record the amount cleared from the bank account. This will be the date as per the Bank Return]

4.4.6.3 **Cancellation of expenditure** - where an issued cheque has been stopped and cancelled by the cheque issuing authority, the following double entry shall be made:

Dr		Cheque clearing account
	Cr	Expenditure head account

[to record cancellation of expenditure]

4.4.6.4 **Unclaimed monies** - where cheques are not cleared from the bank account within the prescribed period and are unclaimed, the above double entry shall be:

Dr		Cheque clearing account
	Cr	Unclaimed money account

---

[to record unclaimed cheques transferred to unclaimed money account within the Public Account]

Dr		Unclaimed money account
	Cr	Bank account

[to record the amount paid from the bank account where the unclaimed money is subsequently claimed]

Dr		Unclaimed money account
	Cr	Other income account

[to record transfer of amount from the unclaimed money account (Public Account) to the other income account (Consolidated Fund) after three years]

4.4.6.5 **Refund** - where a refund has been paid, the following double entry shall be made:

Dr		Refunds account (revenue)
	Cr	Cheque clearing account

[to record refunds paid against a specified 'refunds' account (or as a debit to revenue)]

Dr		Cheque clearing account
	Cr	Bank account

[to record the amount cleared from the bank account. This will be the date as per the Bank Return]

4.4.6.6 **Petty cash expenditure** - The double entries shall be:

Dr		Petty cash account
	Cr	Cheque clearing account

[to establish the petty cash float]

Dr		Cheque clearing account
	Cr	Bank account

[to record the amount cleared from the bank account. This will be the date as per the Bank Return]

Dr		Expenditure
----	--	-------------



## 4.5 Detailed Procedures

### 4.5.1 Introduction

- 4.5.1.1 This section describes the key controls and associated responsibilities for expenditure processing. The processing of expenditures must comply with the directions laid down in previous sections of this chapter.
- 4.5.1.2 This section sets out the procedures to be followed in relation to general expenditures of a department/entity. Procedures for specific types of expenditures are covered from Section 4.6 to 4.12.
- 4.5.1.3 The following key internal controls must be observed in expenditure processing:
- a sequentially numbered purchase order shall be raised by each DDO for all contingent expenditures to be incurred
  - all claim vouchers (bills) shall be approved by a delegated officer within the department/entity
  - all claim vouchers (bills) shall be certified by a certifying officer and authorised for payment by an authorised officer in the District Accounts or the Accountant General office
  - the cheque signing officers shall be independent of officers involved in voucher certification, voucher authorisation and cheque preparation
  - all cheques shall be made out only to the claimant as indicated on the claim voucher (bill)
  - all cheques shall be sent by registered post or other secure means to the payee
  - the daily totals as per Daily Advice Note (DAN), (prepared from the Cheque Register) must be reconciled with the daily expenditures recorded in the Sub Ledger/Abstract
  - a regular bank reconciliation must be performed (Chapter 6)
  - periodical financial reports must be produced and monitored by a delegated authority (Chapter 7)
  - accounting records of expenditure in the DAO/AG/AGPR must be reconciled with each DDO on a monthly basis.

4.5.2 Expenditure processing flowchart

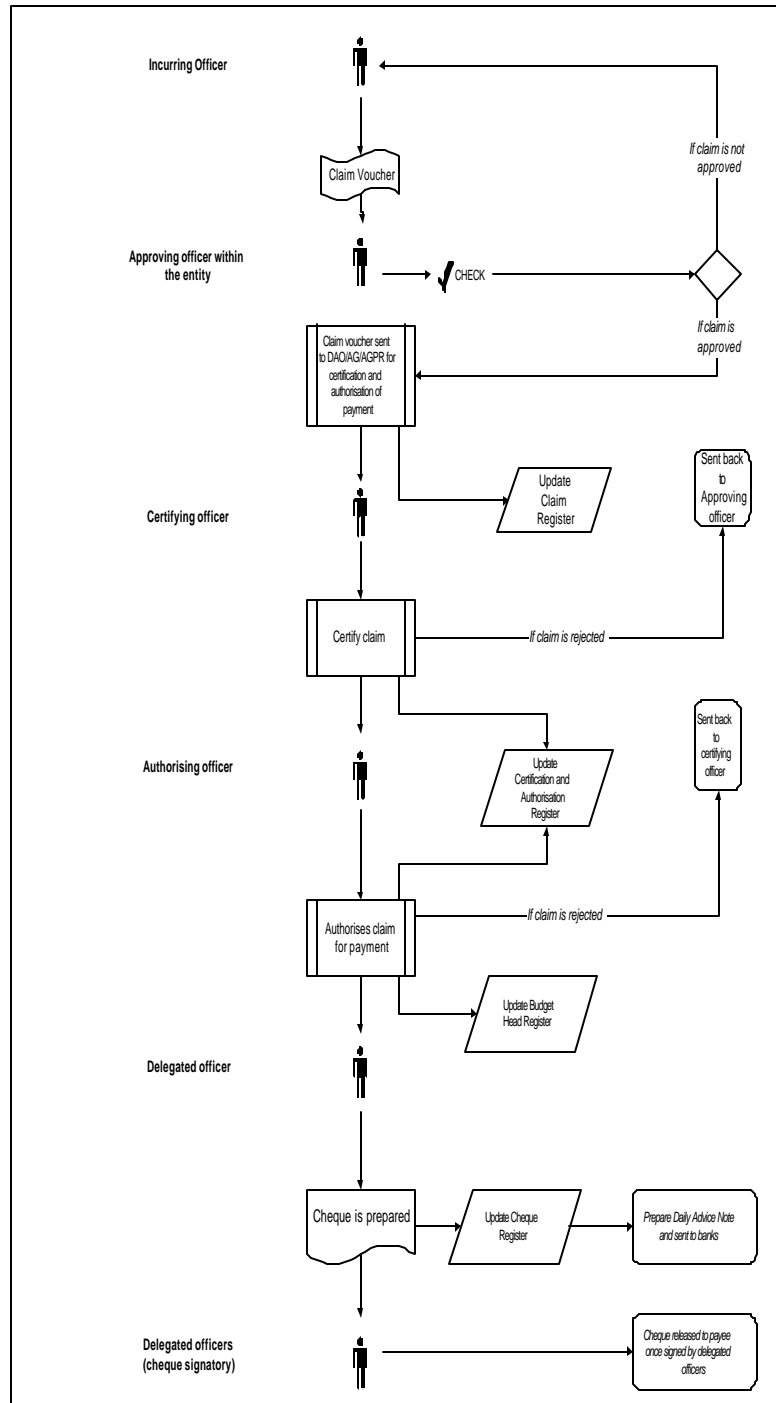

---

### 4.5.3 Voucher preparation for claims above the specified limit

4.5.3.1 All officers making an expenditure claim above the specified limit shall complete the claim voucher form (bill) (form 4B). All sections of the claim voucher form shall be completed in full. The following details must be shown on the claim voucher:

- details of the officer making the claim
- the name of the supplier with National Tax Number (NTN) and full postal address. In case of partnership, companies, association, societies, etc., the registered title
- actual dates of supply or periods of service and the location and nature of service or work in respect of which expenditure is incurred. Each claim should be accompanied by all necessary supporting documentation
- an account number and the name of the expenditure head to which payment will be charged
- a reference number of the contract account, or other registers as the case may be
- for payments in respect of contracts for buildings, works and services, the full amount of the contract and progress payments supported by certificates given by the relevant engineer, architect or other delegated officer as the value of work completed
- deductions made (e.g. withholding tax, security, adjustment of advances etc.)
- a copy (2<sup>nd</sup> copy) of the sequential purchase order attached to the claim voucher.

4.5.3.2 All claim vouchers shall be issued by the department/entity with a unique sequential voucher number. This shall incorporate a reference number for the particular department/entity (the DDO). The DDO must account for any 'gaps' in the sequential number series.

4.5.3.3 The officer making the claim shall provide a statement that the supplies have been received in good order and condition and have been entered in the assets/stock register, and/or the services have been satisfactorily carried out, as provided for in the contract or purchase order.

This shall not apply in circumstances when a deposit or payment in advance as a condition of fulfilling a contract, is unavoidable.

Unavoidable payments in advance include travel tickets, subscriptions and various application fees and deposits which are normally prepaid.

---

Prior approval of such expenditure, by a delegated officer, is still required and must be accompanied by a certification that payment in advance is necessary and unavoidable because of the nature or terms or conditions of the contract for the supply of goods/services. In these cases, the following additional procedures must be followed:

- the claim voucher must be prominently stamped “PAID IN ADVANCE”
- the delivery of outstanding goods and services should be followed up at regular intervals by the department/entity.

4.5.3.4 Where a duplicate claim voucher is issued, it shall have the word “DUPLICATE” written or stamped prominently upon the face of the voucher. The duplicate claim voucher shall also have reference to the original claim voucher. Where a duplicate claim voucher is issued, the officer shall state the reasons for its issue.

4.5.3.5 Where payment relates to a commitment previously entered into by the entity, the claim voucher shall give reference details to the commitment advice form already sent by the DDO to the DAO/AG/AGPR office (also see Section 4.3.3).

4.5.3.6 Particulars entered on all claim vouchers shall be typed or written in ink, and be free from erasures. Where an alteration is found to be necessary, the word or figure shall be ruled through and the correction made. All such alterations shall be initialled by the officer making the claim. Where there are numerous alterations a fresh claim voucher shall be prepared and the original claim voucher shall be cancelled and filed by the officer.

4.5.3.7 The claim voucher shall then be presented to a delegated officer, within the same department/entity, for approval.

#### **4.5.4 Approval of expenditure**

4.5.4.1 The approving officer shall approve the claim voucher (bill) if satisfied that payment can be made under his/her delegated financial powers.

4.5.4.2 The approving officer shall review the claim voucher and all relevant supporting documents, including the authorised purchase order.

4.5.4.3 Every delegated officer who approves a claim shall have an “Official Stamp” for that department/entity. The delegated officer shall put the official stamp on the claim voucher once he/she approves the claim for payment.



- 
- 4.5.4.4 The approving officer shall ensure that the account to which the voucher is to be charged is correct and is shown on the face of each voucher.
- 4.5.4.5 The approving officer shall ensure that the service or supply has been performed or received, or, where it is necessary to pay in advance, the payment is properly due.
- 4.5.4.6 If the approving officer is not satisfied with the claim he/she shall not approve the expenditure and return the claim voucher and any supporting documents to the officer who prepared the claim, with written reasons for refusal.
- 4.5.4.7 Once the officer who prepared the claim rectifies the reasons for refusal, he/she can re-present the claim to the approving officer for approval.
- 4.5.4.8 If the approving officer is satisfied with the claim, he/she shall sign the original claim voucher and initial all documents supporting the claim. This shall indicate the capacity in which the approving officer has signed and the date of signing.
- 4.5.4.9 The approving officer shall send the following documents along with the original claim voucher to the relevant DAO/AG/AGPR office.
- original approved purchase order
  - attested copy of approved contract with the supplier (where applicable)
  - original approved bills (invoices) from the supplier.

#### **4.5.5 Registration of purchase order/claim voucher**

- 4.5.5.1 A “Claim Register” (Bill Register) in DDO-wise order (form 4H) shall be kept by a delegated officer in the office of the DAO/AG/AGPR.
- 4.5.5.2 When a sequential purchase order is submitted to the DAO/AG/AGPR, the delegated officer shall check the sequential number of the purchase order for the relevant DDO, by checking with the Claim Register.
- 4.5.5.3 Where the sequential number of the purchase order is incorrect, the delegated officer shall return the purchase order to the relevant DDO.
- 4.5.5.4 The DDO shall resubmit the correct sequential purchase order or the reason for the missing purchase order in writing.

- 
- 4.5.5.5 Where the sequential number of the purchase order is correct, the delegated officer shall enter the sequential number in the Claim Register and shall forward the purchase order to the certifying officer.
- 4.5.5.6 When a claim is submitted (or re-submitted) in the office of the DAO/AG/AGPR, the delegated officer shall check the sequential number of the claim voucher for the relevant DDO, by checking with the Claim Register.
- 4.5.5.7 Where the sequential number of the claim voucher is incorrect, the delegated officer shall return the claim voucher to the relevant DDO.
- 4.5.5.8 Where the sequential number of the claim voucher is correct, the delegated officer shall enter the sequential number in the Claim Register.
- 4.5.5.9 The delegated officer shall then give its own (i.e. DAO's) unique claim number, being the next sequential number on the claim register. The date the claim is received shall be recorded in the claim register. The delegated officer shall then pass on the claim to the certifying officer dealing with that department/entity (DDO).
- 4.5.5.10 If a claim is returned to the officer who submitted the claim for any reason, it shall be recorded in the claim register along with the date it is returned to the department/entity.

#### **4.5.6 Certification (pre -audit) of expenditure**

- 4.5.6.1 The certifying officer shall record details of the claim in the "Certification and Authorisation Register" (form 4I).
- 4.5.6.2 The certifying officer shall certify the claim as per policies laid down in Section 4.2.7.
- 4.5.6.3 The certifying officer shall ensure that:
- the claims submitted to his/her office are valid claims that have been duly approved and there is no reason to believe that the claims should not be paid
  - the claim voucher (bill) is complete, duly approved and signed by the delegated officer of the entity
  - the claim voucher (bill) has the proper official stamp on it
  - supporting documents accompanying the claim are valid, duly approved and signed by the delegated officer
  - the delegated officer who has approved and signed the voucher and supporting documents, is an officer authorised to approve such claims within that entity and has not exceeded his/her authority

- 
- the claim must not have been previously paid (especially in respect of claims issued on a duplicate voucher)
  - the claim must identify the head of expenditure to which the amount is chargeable.
- 4.5.6.4 The certifying officer shall check the 2<sup>nd</sup> copy of the purchase order, sent along with the claim voucher, to the purchase order previously sent. If the two copies of the purchase order do not agree, the officer shall reject the claim voucher.
- 4.5.6.5 If the certifying officer requires additional information or documents, he/she shall obtain them from the department/entity.
- 4.5.6.6 Where the certifying officer is not satisfied with the claim, the officer shall not approve it and refer the claim to his/her next higher authority along with his/her specific observations.
- 4.5.6.7 On rejection the officer shall return the claim voucher and all supporting documents to the concern DDO, with written reasons for refusal. The claim voucher shall be endorsed as rejected.
- 4.5.6.8 The certifying officer shall only entertain such rejected claims where the approving officer provides written explanation in support of the claim.
- 4.5.6.9 Once the certifying officer is satisfied with the claim, he/she shall sign and date the claim voucher, update the Certification and Authorisation Register and pass on the claim to the authorising officer.
- 4.5.6.10 When the certifying officer receives the purchase order, with or without a commitment advice form, the officer shall review the purchase order, in light with the commitment criteria as set out in section 4.3.3, to certify whether or not a commitment is properly raised by the DDO.
- 4.5.6.11 In cases where a commitment advice is sent with the purchase order and the certifying officer disagrees with the DDO in relation to commitment, the officer shall communicate with the DDO and resolve any disagreement.
- 4.5.6.12 In cases where a commitment advice is not sent with the purchase order and the certifying officer feels (in accordance with the commitment criteria) that a commitment needs to be set up, the officer shall communicate with the DDO and resolve any disagreement.
- 4.5.6.13 Where the purchase order meets the commitment criteria and the certifying officer is in agreement with the DDO, the officer shall sign the commitment advice form and shall pass it on to the authorising officer.
-

---

#### **4.5.7 Authorisation of payment**

- 4.5.7.1 The authorising officer shall authorise the claim for payment as per policies laid down in Section 4.2.8.
- 4.5.7.2 The authorising officer shall ensure that the claim voucher (bill) bears valid evidence that preparation, approval and certification have been properly carried out. This officer shall also ensure funds are available to make the payment, or enter the commitment, as the case may be.
- 4.5.7.3 If the authorising officer is not satisfied with the claim, he/she shall not authorise the payment and return the claim voucher and all supporting documents to the certifying officer who certified the claim, with written reasons for refusal. The claim voucher shall be endorsed as rejected.
- 4.5.7.4 If the certifying officer is able to rectify the reasons for refusal, the officer shall rectify it and resubmit to the authorised officer. If the certifying officer is not in the position to rectify the reasons for refusal, he/she shall return the claim voucher and all supporting documents to the officer who originally submitted the claim to the office, with written reasons for refusal.
- 4.5.7.5 Once the delegated officer in the department/entity rectifies the reasons for refusal, the officer shall re-submit the claim to the office of the DAO/AG/AGPR. The claim voucher shall be given a new claim number.
- 4.5.7.6 Where the authorising officer receives a commitment advice form signed by the certifying officer, the authorising officer shall enter the commitment in the "Appropriation Control Register" (form 4D) in accordance with section 4.4.2.
- 4.5.7.7 Where the authorising officer is satisfied with the claim voucher, he/she shall authorise the claim voucher for payment, sign and date the Certification and Authorisation Register and pass on the claim voucher to the relevant officer for the issue of a cheque. At the same time the authorising officer shall update the Appropriation Control Register and in doing so, reverse any commitments that may have been previously established.

#### **4.5.8 Preparation and dispatch of cheques**

- 4.5.8.1 A delegated officer within the AG/DAO/AGPR shall prepare and dispatch the cheque to the claimant as per policies laid down in Section 4.2.9, 'Issue of payment'.

- 
- 4.5.8.2 All cheques must be serially numbered and bear the identity of the issuer's office.
- 4.5.8.3 Cheques shall be either typed or hand written. All cheques shall be drawn "to order" and shall be crossed and marked "Not Negotiable", except cheques drawn in the name of the DDO for imprest and for salaries paid in cash.
- 4.5.8.4 The amount payable shall be expressed in both words and figures on all cheques.
- 4.5.8.5 Where hand written cheques are issued, the cheques shall not be prepared or signed using pencil or erasable ink type pens.
- 4.5.8.6 The delegated officer who prepares the cheque shall enter the cheque details in the "Cheque Register" (form 4J).
- 4.5.8.7 It is responsibility of the cheque signing officers to ensure that:
- the cheque is not back-dated (i.e. given an earlier date than the date on which it is prepared)
  - the amount and full name of payee of each cheque agrees with the amount and name of payee as shown on the authorised voucher for payment
  - payment shall be evidenced on the claim voucher by stamping the claim voucher with the word "PAID" and the relevant details of the payment, i.e. cheque number, date, amount paid as per cheque.
- 4.5.8.8 Before a cheque is released to the payee, or personally collected by the payee or his authorised agent, it shall be recorded as 'PAID' in the claim register along with the date it is posted to, or collected by, the payee.

#### **4.5.9 Expenditure payments below the specified limit**

- 4.5.9.1 All expenditures below the specified limit shall be paid by the DDO through the imprest account and shall follow directions as laid down in Section 4.2.10.
- 4.5.9.2 Where petty cash advances are given from the imprest account, the delegated officer responsible for imprest account, will make note of such petty cash advances in the petty cash (imprest account) register and ensure that valid petty cash voucher are supplied against such advances. The recipient of the advance shall sign the petty cash register.
- 4.5.9.3 The DDO shall submit an "imprest account claim" (form 4K) to the DAO/AG/AGPR, after approval by a delegated officer within the

---

department/entity. This claim must be accompanied by all original petty cash vouchers for amounts in excess of Rs. 200.

4.5.9.4 The procedures for recording claims in the claim register, certification of claim, authorisation for payment and preparation and dispatch of cheques shall be same as indicated in previous sections.

4.5.9.5 For imprest accounts, the cheque for reimbursement is made out in the name of the DDO, being the claimant of the imprest account claim.

#### **4.5.10 Timing and priority of the claim**

4.5.10.1 A delegated officer in the office of the DAO/AG/AGPR shall monitor the timing of claims submitted to the office and ensure the following:

- claims, if not rejected or returned back to the department /entity, are paid within 7 working days of recording in the claim register
- priority is given to claims in view of their due date of payment and the date on which claim is received by the DAO/AG/AGPR office.

#### **4.5.11 Stop payment and replacement cheque**

4.5.11.1 When a cheque needs to be stopped, the delegated officer who prepared the cheque shall first determine whether the cheque has been presented and paid by the bank on which the cheque was drawn, i.e. can the stop be effective? If the cheque has not been paid, a stop payment notice shall be lodged promptly with the bank. The bank's written acknowledgement must be obtained in such circumstances.

4.5.11.2 When payment of a cheque is stopped, the details shall be recorded in the cheque register.

4.5.11.3 If a cheque payment is stopped or cancelled, the delegated officer shall reverse the original expense entry in the Sub-ledger, and where required, re-establish the previously raised commitment. Where the stopped or cancelled cheque relates to prior year then the entry shall be reversed in accordance with policies laid down in section 7.3 - Year-end Accounting Policies of chapter 7 of this Manual.

4.5.11.4 Also refer to FTR rules 165 and 193 for relevant government instructions on this matter.

#### **4.5.12 Unclaimed and stale cheques**

4.5.12.1 If a cheque payment is unclaimed or stale, the delegated officer shall record the details in the cheque register, on the relevant claim voucher and make the required adjustment in the Sub Ledger as set

---

out in Direction 4.4.6.4. This provides an audit trail that enables prompt payment if the money is subsequently claimed.

#### **4.5.13 Daily Advice Note to bank**

- 4.5.13.1 The delegated officer who prepares and dispatches the cheques shall also prepare a "Daily Advice Note" (form 4L) from the cheque register, once the cheque is signed by the cheque signatory officers and before it is dispatched to the payee.
- 4.5.13.2 The Daily Advice Note is prepared on a daily basis and shall include all cheque payments dispatched on that day.
- 4.5.13.3 The Daily Advice Note shall be sent to the designated bank branch by the officer at the end of that day, to arrive at bank by 9 am next working day.
- 4.5.13.4 A copy of the Daily Advice Note shall be sent to the Account Section on a daily basis.

**4.5.14 Recording, consolidation and reporting of expenditure flowchart**

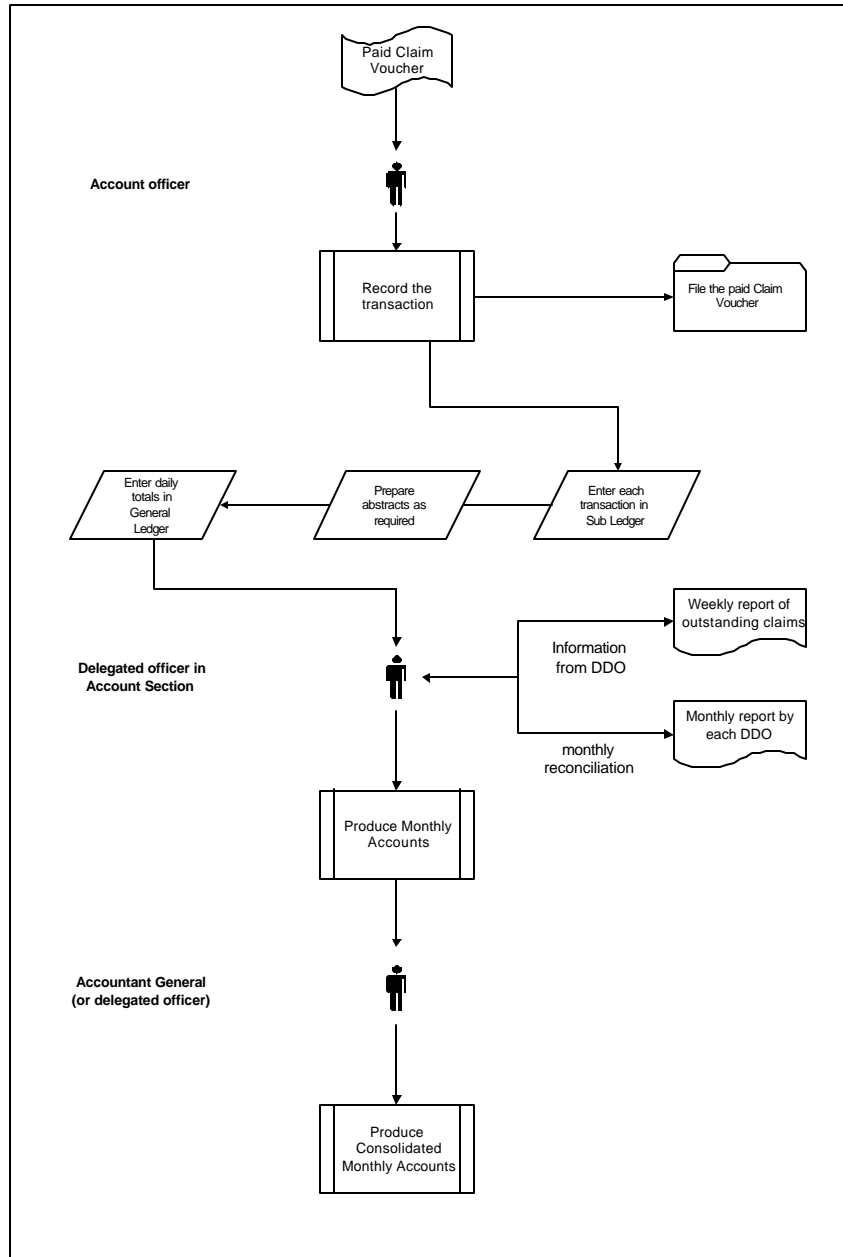



---

**4.5.15 Recording of expenditures**

- 4.5.15.1 Once a cheque is dispatched to the payee, the claim voucher shall be forwarded to the Account Section of the DAO/AG/AGPR office.
- 4.5.15.2 In the Account Section, the delegated accounts officer shall record details of expenditure, as stated on the claim voucher, in the Sub Ledger as per directions laid down in Section 4.4 “Accounting for Expenditures”.
- 4.5.15.3 Once an expenditure is recorded the claim voucher and all supporting documents shall be filed by the accounts officer.

**4.5.16 Consolidation of expenditures**

- 4.5.16.1 On the basis of the Sub Ledger, the accounts officer shall prepare an abstract (form 4GG) which gives daily totals of expenditure entered into the accounting system.
- 4.5.16.2 A delegated officer in the Account Section of the DAO/AG/AGPR office shall consolidate the expenditures, on a monthly basis, from the entries in the General Ledger and include them in the Monthly Accounts. Also refer to Section 4.4 “Accounting for Expenditures”.

**4.5.17 Reporting of expenditures**

- 4.5.17.1 The DAO/AG/AGPR office shall prepare a monthly report “Disbursement Confirmation Statement” (see section 4.2 of FRM) from the claim register for each DDO which gives detail of claims submitted by the DDO and payment made against the claims.
- 4.5.17.2 The DAO/AG/AGPR office shall prepare a weekly report of all outstanding claims and their status. Also refer to Chapter 7. ‘Financial Reporting Procedures’
- 4.5.17.3 All expenditures shall be reported to the Accountant General as part of the Monthly Accounts prepared by the District Accounts office/Self-accounting entities.
- 4.5.17.4 From the Monthly Accounts received from the District Accounts offices/Self-accounting entities, the Accountant General shall produce the Consolidated Monthly Accounts for the Provincial Government or the Federal Government, as the case may be.

**4.5.18 Reconciliation of expenditures**

- 4.5.18.1 The delegated officer in the Account Section shall agree the abstract’s daily totals with the daily totals as per DAN, on a daily basis.

- 
- 4.5.18.2 The delegated officer in the Account Section of the DAO/AG/AGPR office shall reconcile expenditure with each DDO on a monthly basis, based on the cheque register.
- 4.5.18.3 The Bank will send the “Bank Return” (along with paid cheques) to the Account Section, where a delegated officer shall check the Bank Return (and paid cheque) with the copy of the Daily Advice Note. The officer shall investigate any item which is on Bank Return but not on Daily Advice Note and vice versa.
- 4.5.18.4 The officer in the Account Section shall ensure that the Bank Returns are received from the banks on daily basis. If not, the officer shall report to the District Account Officer/Accountant General.
- 4.5.18.5 Items which are on Daily Advice Note but not on Bank Return usually represent “unpresented cheques” and form part of monthly bank reconciliation. These payments should be presented within the validity period for issued cheques. If not, these payments are transferred to unclaimed money account as laid down in Sections 4.2.13 and 4.5.12.
- 4.5.18.6 The delegated officer in the Account Section of the DAO/AG/AGPR office shall prepare a bank reconciliation as laid down in Chapter 6. The bank reconciliation will enable the DAO/AG/AGPR to reconcile expenditure payments with the bank.
- 4.5.18.7 Once the delegated officer in the Account Section is finished with the Bank Returns, they should be sent to the officer who prepared the cheque. This officer shall enter the details from the Bank Returns into the Cheque Register and reconcile the cheques issued by the office and cleared by the bank. A report of this reconciliation shall be sent to the Account Section which should also indicate those cheques which are not yet cleared by the bank.
- 4.5.18.8 The delegated officer shall compare the Cheque Register with the Authorisation Register to verify that the amount of cheques issued was in accordance with the authorisation.

---

## Procedures for Specific Types of Payments

### 4.6 Salaries and Wages

#### 4.6.1 Introduction

4.6.1.1 The following key internal controls must be observed in processing of payroll.

- employees shall be paid by direct credit into their bank account regardless of their grade level and may apply to be paid through the cheque system
- employees below grade V may elect to be paid in cash. In this case, payment shall be made in cash through the relevant DDO. See Section 4.6.13 “Payment in cash to employee below grade V”

4.6.1.2 The powers in relation to creation and continuation of posts, payment against such posts, allowing increment or reduction in employee’s salaries and regulating their perquisites are prescribed in the relevant financial and administrative rules.

#### 4.6.2 Due date

4.6.2.1 Monthly salaries and allowances of government employees shall be paid on the first working day of the following calendar month.

4.6.2.2 The exception to this rule is in relation to public and festival holidays (e.g. Eid holidays) for which reference shall be made to FTR (rules 217 and 219) and the relevant government notifications.

#### 4.6.3 Payment by direct credit

4.6.3.1 The normal method of payment of monthly salaries of all government employees shall be by credit transfer direct to a bank account nominated by the employee. This is the most secure and economical method of payment, and it automatically ensures that recipients have access to their salary on the due date. Moreover, direct credit has tangible advantages, over payment by cheque or cash, against risks of theft or fraud.

4.6.3.2 To enable payroll payments to be made by direct credit, an employee shall make an application (form 4X) to the DAO/AG/AGPR nominating the account with a bank to which pays may be credited. The application shall specify the name and branch of the bank, the full title of the nominated account and the account number.

---

**4.6.4 Payment by cheque**

4.6.4.1 If payment is made by cheque, it should be handed over to the employee against proper acknowledgement on the due date.

**4.6.5 Deductions from salaries and wages**

4.6.5.1 No deduction shall be made from salaries or wages unless prescribed by an Act or Statute or by any order of a Court of Law. The deductions shall be on the basis of rules or standing orders of the Government.

4.6.5.2 Deductions shall be made from employee's monthly pay in accordance with the rules and regulations of GP Fund. The monthly deduction is the same throughout a financial year. The GP Fund monthly deductions of a subscriber shall be reported to the GP Fund Section. Detailed procedures on GP Fund are covered in section 4.8 of this chapter.

4.6.5.3 Income tax deductions from the monthly pay shall be made strictly in accordance with the relevant provisions of the Income Tax Ordinance, 1979 as modified from time to time and the rules, orders and instructions issued from time to time by the Central Board of Revenue.

4.6.5.4 Other payroll deductions (e.g. house rent deductions, deductions for loan and advances) shall be made in accordance with the rules and regulations governing the deduction.

4.6.5.5 Any change in employees' allowances and deductions shall be notified through the change statement to the DAO/AG/AGPR.

**4.6.6 Transfers of employees to other departments/entities**

4.6.6.1 Where practical, transfers of staff should be made on a day immediately following the due date of payment.

4.6.6.2 When an employee is transferred, payment shall be charged to the first department only to the date of transfer and payment from this date shall be charged to the department to which the employee is transferred. The pay shall be allocated on the basis of working days in the month. This allocation will be processed through separate journal entry.

4.6.6.3 The first department/entity from which the employee is transferred shall immediately inform the relevant DAO/AG/AGPR office the details of transfer, including the date of transfer and to which department/entity the employee is being transferred.

---

4.6.6.4 The DAO/AG/AGPR office shall issue a “Last Pay Certificate” (form 4Y) to the employee and the delegated officer shall ensure that the employee has been removed from the employee’s payroll system.

4.6.6.5 The delegated officer shall send a copy of the last pay certificate to the relevant office of DAO/AG/AGPR from which the employee will withdraw his/her pay. This office shall ensure that the employee is entered onto their payroll system from the date of transfer.

4.6.6.6 In cases where an employee’s Last Pay Certificate is delayed, the Accountant General may authorise a ‘provisional payment of salary’ to the employee.

#### **4.6.7 Deputation**

4.6.7.1 Except as set out in direction 4.6.7.2, staff on deputation should be charged to the department or entity to which the staff have been provided.

4.6.7.2 Where the deputation of staff is of a purely casual or temporary nature and for a strictly limited period of time the parent department shall continue to bear the cost of the staff member’s salary without recovery. But such cases should be regarded as exceptional and in any event should not be allowed to continue for more than 3 months.

#### **4.6.8 Final payment**

4.6.8.1 The last payment of salary and allowances shall not be paid to employee leaving the service of the Government due to resignation, dismissal, or otherwise, until both the DDO and the Accountant General are satisfied that there is no outstanding amount due from the employee.

4.6.8.2 Where an employee is leaving the service of the Government due to retirement, the last payment of salary and allowances shall not be held up merely to verify that no outstanding amount is due from the employee. The employee shall agree in writing that any valid outstanding amount coming to notice within a period of one year from the date of retirement may be recovered from the pension payments.

#### **4.6.9 Payment of sums due at death**

4.6.9.1 On a death of a person to whom any sum is due in respect of pay, allowances, annuity or gratuity, payment can only be made either to a valid nomination made by the deceased or to a personal representative of the deceased on production of proof of entitlement in the form of Letters of Administration or other legal authority.

4.6.9.2 If any payment due is not claimed by the valid nomination made by the deceased or to a personal representative of the deceased, the amount shall be transferred to unclaimed money account as laid down in Sections 4.2.13 and 4.5.12.

#### **4.6.10 Leave Payment**

4.6.10.1 Payments in relation to earned leave, casual leave, sick leave, long service leave or other kinds of leave shall be made in accordance with the relevant rules and regulations issued by the Government and provided under the Fundamental and Supplementary Rules.

4.6.11 Payroll processing flowchart

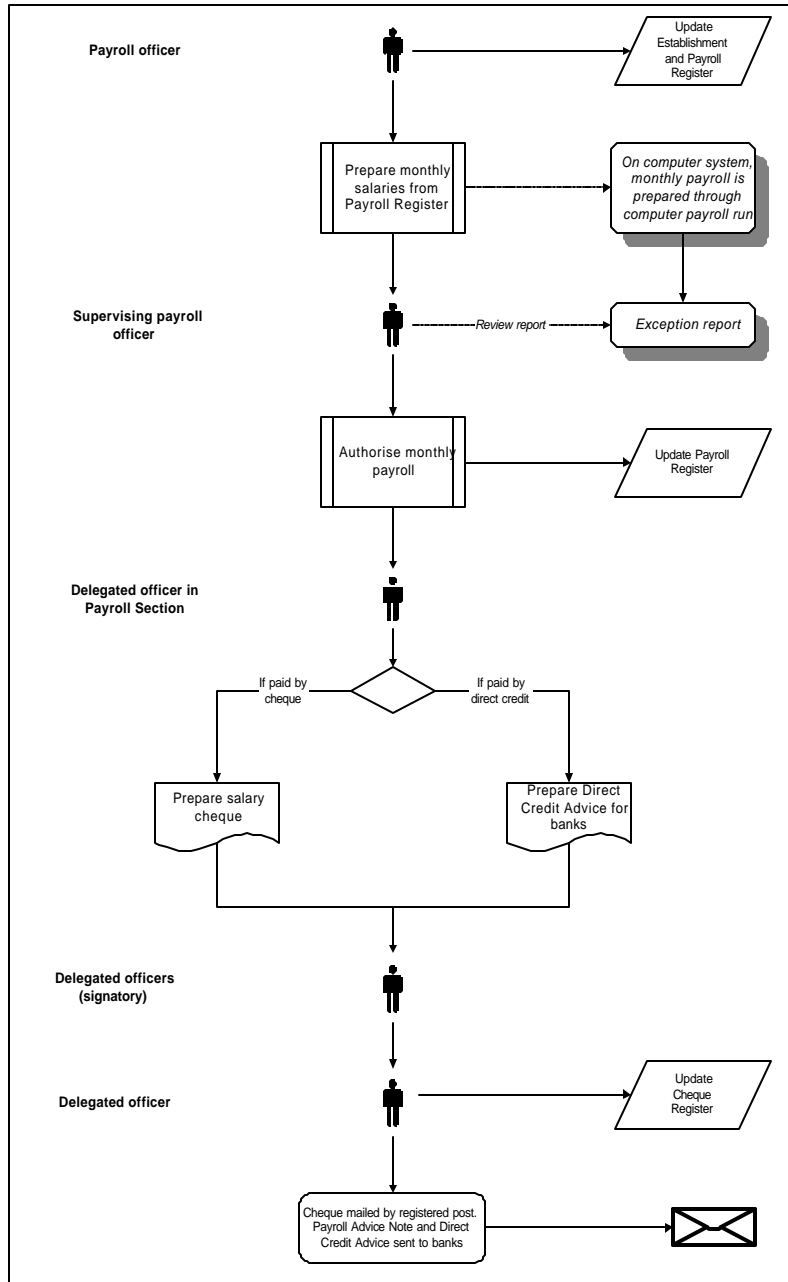

---

#### 4.6.12 Payroll processing

- 4.6.12.1 Any change in staffing structure of a department/entity whether due to transfer, deputation, secondment, appointment, resignation, dismissal, retirement, or death shall be immediately notified by the DDO of that department/entity to the Payroll Section of the relevant office of the DAO/AG/AGPR.
- 4.6.12.2 Any change in employee's pay scale shall be immediately notified by the concerned DDO or the Department/Division to the Payroll Section of the relevant office of the DAO/AG/AGPR and be applicable from the date indicated in the notification.
- 4.6.12.3 A delegated officer in the Payroll Section shall review the above notifications and authorise it for updating the "Establishment Register" (also see Section 4.14.2).
- 4.6.12.4 The payroll officer in the Payroll Section shall update the Establishment Register, as per the authorised notification, (manually or maintained on the computer system) and file the notification.
- 4.6.12.5 Any change in employee's allowances or deductions shall be immediately notified by the DDO to the Payroll Section of the relevant office of the DAO/AG/AGPR and be applicable from the date indicated in the notification.
- 4.6.12.6 A delegated officer in the Payroll Section shall review the above notification and authorise it for updating the "Payroll Register" (also see Section 4.14.3).
- 4.6.12.7 The payroll officer in the Payroll Section shall update the Payroll Register, as per the authorised notification, (manually or maintained on the computer system) and file the notification.
- 4.6.12.8 A payslip (an authorisation of any changes) is produced for an employee every time an employee's salary, allowances or deductions is changed. This payslip is sent by registered post (along with monthly salary cheque, where applicable) to the employee at the end of the month in which the change arises.
- 4.6.12.9 A Monthly Salary Statement will be produced by the computer section on a monthly basis for each employee on the payroll.
- 4.6.12.10 On the basis of the Payroll Register, the payroll officer shall prepare a monthly schedule of employees' salaries by 26th of each month. Any change notification received in relation to employee's salary or allowances after 25th of a month shall be adjusted in next month's payroll.



- 
- 4.6.12.11 Where a computerised system is used, the monthly schedule is automatically produced as part of the monthly payroll run. The computerised payroll system will also produce an exception report in relation to staff salaries (e.g. monthly salaries exceeding a set amount, variation between current month and last month).
- 4.6.12.12 The supervising payroll officer shall review and verify the monthly schedule of employees' salaries and authorise it for payment once he/she is satisfied with the payroll schedule. At the same time the officer shall update the Payroll Register.
- 4.6.12.13 The supervising payroll officer shall:
- Check that all amendments to payroll are accurate and there are no unauthorised amendments
  - compare current month payroll to last month and review any exceptions
  - compare manual payroll to computer payroll to ensure that no employee is paid twice.
- 4.6.12.14 Once the monthly payroll schedule is authorised for payment, a delegated officer (independent of payroll officer and supervising payroll officer) shall prepare the "Payroll Credit Advice" (form 4M) for direct credit payments.
- 4.6.12.15 Where salary payment is paid by cheque, the delegated officer shall prepare salary cheques as per directions laid down in Sections 4.2.9 and 4.5.8.
- 4.6.12.16 Two delegated officers (signatories) shall sign the Direct Credit Advice and the cheques.
- 4.6.12.17 The Direct Credit Advice shall be sent to the banks by a delegated officer 3 working days before the end of the month for direct credit into the employee's bank account on the 1st working day of the following month.
- 4.6.12.18 The relevant officer who prepares and dispatches the cheques shall also prepare the "Payroll Advice Note" (form 4L) once the cheque is signed by the cheque signatory officers and before it is dispatched to the payee. The Payroll Advice Note shall be sent to the bank on the last working day of the month.
- 4.6.12.19 The delegated officer who prepares the cheque shall enter the cheque details in the "Cheque Register" (form 4J).
- 4.6.12.20 A copy of the Direct Credit Advice and the Payroll Advice Note shall be sent to the Account Section.
-

---

4.6.12.21 Where an employee's salary payment is paid incorrectly, the adjustment shall be made in next month's salary payment.

#### **4.6.13 Payment in cash to employee below grade V**

4.6.13.1 Payroll payments in cash (i.e. through bearer cheque) shall only be allowed by the Accountant General in special circumstances and not for employees in grade V and above.

4.6.13.2 The PAO (through relevant DDO) responsible for the employees receiving cash pays shall give directions that provide for:

- adequate safeguarding of cash
- use of security for transportation and delivery of salaries having regard to the amount of the payroll and the inherent risks in conveying cash through public places
- preparation of pay envelopes by a delegated officer
- proof of payments to employee and payments to authorised representative
- actions to be undertaken in the event of losses and discrepancies.

4.6.13.3 It is the responsibility of the PAO (through relevant DDO) to ensure that arrangements for an employee's pay to be collected by or directed to someone other than the employee are backed up by proper departmental controls to mitigate the risk of theft or fraud.

4.6.13.4 Through the monthly payroll procedures as set out in Section 4.6.12 "Payroll processing", the Payroll Section shall issue the monthly salary cheque in the name of relevant DDO for those employees who exercise their option to be paid in cash and are below grade V.

4.6.13.5 Once the relevant DDO encashes the salary cheque, he/she shall disburse the pays to relevant employees as per departmental directions.

4.6.13.6 The DDO shall submit a monthly statement to the DAO/AG/AGPR office which certifies that either all relevant employees were paid in cash or state the name of employees not paid, the related amount and the reasons of non-payments.

#### **4.6.14 Recording of payroll expenditure**

4.6.14.1 In the Account Section the delegated officer shall record details of payroll, as stated on the authorised Payroll Advice Note and Payroll Credit Advice sent by the Payroll Section, in the Sub Ledger as per directions laid down in Section 4.4 "Accounting for Expenditures".

4.6.14.2 Once the payroll expenditure is recorded the Payroll Advice Note and Payroll Credit Advice shall be filed.

4.6.14.3 Where a salary cheque is not received by the employee or salary is not transferred to his/her bank account, the recovery action shall be carried out as per Section 4.2.12 "Stop payment and replacement cheque".

4.6.14.4 The following double entry shall be made to record the payroll transactions in the Sub-ledger at the time of payment of salary:

Dr	Salary account (gross pay)
Cr	Bank account (net pay)
	Revenue Head account (income tax)
	GP Fund account
	Other accounts

4.6.14.5 Also at the time of payment, the following double entry shall be made in the Appropriation Control Register to reduce the balance of available funds:

Update	Appropriation control (salaries) ( - )
Update	Funds available (salaries) ( - )

#### **4.6.15 Consolidation of payroll expenditure**

4.6.15.1 The delegated officer in the Account Section of the DAO/AG/AGPR office shall consolidate the expenditures, on a monthly basis, from the entries in the General Ledger and include them in the Monthly Accounts. Also refer to Section 4.4 "Accounting for Expenditures".

#### **4.6.16 Reporting of payroll expenditure**

4.6.16.1 The DAO/AG/AGPR office shall prepare a monthly report for each DDO. It gives details of salaries and wages paid for employees working in their department/entity.

4.6.16.2 Payroll expenditure will form part of the Monthly Accounts prepared by the District Accounts office which will be reported to the Accountant General each month.

4.6.16.3 From the Monthly Accounts received from the District Accounts offices, the Accountant General shall produce the Consolidated Monthly Accounts for the Provincial Government or the Federal Government, as the case may be.

---

**4.6.17 Recording, consolidation and reporting of payroll expenditure flowchart**

4.6.17.1 The flowchart as shown in Section 4.5.14 ‘Recording, consolidation and reporting of expenditure flowchart’ is also applicable in payroll expenditure. The main difference is that the Payroll Advice Note and Payroll Credit Advice replaces paid claim voucher as the source document for recording purpose.

**4.6.18 Reconciliation of payroll expenditure**

4.6.18.1 The Bank will send the ‘Bank Return’ to the Account Section, where a delegated officer shall check the Bank Return with the copy of the Payroll Advice Note and Payroll Credit Advice. In respect of the Payroll Credit Advice the total will be reconciled with the total appearing on the Bank Return. The officer shall investigate any item which is on the Bank Return but not on Payroll Advice Note and Payroll Credit Advice, and vice versa.

4.6.18.2 Items which are on the Payroll Advice Note and the Payroll Credit Advice, but not on the Bank Return usually represent ‘unpresented cheques’ due to timing differences and form part of monthly bank reconciliation. These payroll payments should normally be cleared during the next month.

4.6.18.3 Once the delegated officer in the Account Section is finished with the Bank Returns, these returns should be sent to the officer who prepare the cheque. This officer shall enter the details from the Bank Returns into the Cheque Register and reconcile the cheques issued by the office and cleared by the bank. A report/schedule of this reconciliation, that should also indicate those cheques that are not yet cleared by the bank, shall be sent to the Account Section.

---

## **4.7 Pension Payments**

### **4.7.1 Introduction**

- 4.7.1.1 Procedures described in the provisions of any rule contained in the Civil Service Regulations or of any departmental regulations issued by, or under the authority of, the President shall be applicable to pensions.
- 4.7.1.2 This Section covers the pension payments in relation to all ex-employees (past employees), who were in the civil service of the Federal and Provincial Government.

### **4.7.2 Due date**

- 4.7.2.1 The monthly pension shall be paid on the first working day of the following calendar month, being the due date of payment. Where an employee is retired during a month, the pension payment for that month is allocated on a working day basis.

### **4.7.3 Payment by direct credit**

- 4.7.3.1 The normal method of payment of pension shall be by credit transfer direct to a bank account nominated by the employee. This is the most secure and economical method of payment, and it automatically ensures that pensioners have access to their pension on the due date. Moreover, direct credit has tangible advantages, over payment by cheque, against risks of theft or fraud.
- 4.7.3.2 For the purpose of enabling pension payments to be made by direct credit, the pensioner shall furnish to DAO/AG/AGPR a payment authority nominating the account with a bank to which pension payment may be credited. The authority shall specify the name and branch of the bank, the full title of the nominated account and the account number.
- 4.7.3.3 Where a pension is paid through direct credit transfer, the pensioner shall personally visit the relevant DAO/AG/AGPR every three months and present his/her "Pension Book" and "National Identity Card". The delegated officer in the DAO/AG/AGPR shall certify that the pensioner is alive, and shall sign, date and stamp the Pension Book for the last three months. At the same time the officer shall update the pension records.

---

#### **4.7.4 Payment by cheque**

- 4.7.4.1 If the pensioner elects to be paid by cheque instead of payment by direct credit transfer, the pension cheque shall be mailed to the pensioner by registered post.
- 4.7.4.2 Where a pensioner is paid by cheque, he/she shall furnish to the DAO/AG/AGPR a payment authority nominating the address to which cheques may be posted.
- 4.7.4.3 The pension cheque shall be in the name of the pensioner and shall be crossed and marked "Not Negotiable".
- 4.7.4.4 Only official Government issued cheques shall be used for pension payments and shall be so marked. The pension cheque shall only be presented at the designated branch of the National Bank of Pakistan as agreed between the pensioner and the DAO/AG/AGPR office.
- 4.7.4.5 The pensioner shall personally present the pension cheque, along with his/her Pension Book and National Identity Card, at the designated branch of the National Bank of Pakistan. The bank officer shall cash the pension cheque after certifying the identity of the pensioner, and shall sign, date and stamp the Pension Book for the month.

#### **4.7.5 Pension Payment Order (Pension Book)**

- 4.7.5.1 The Pension Book shall be issued by the DAO (for non-gazetted staff) and by the Accountant General (for gazetted staff).
- 4.7.5.2 The Pension Book shall include:
- a specimen signature of the pensioner. For illiterate pensioners, his/her thumb impression from the left hand
  - the specimen signature and thumb impression shall be duly attested by the head of the office concerned or by some other delegated officer
  - a certified copy of the pensioner's photograph in passport size shall be laminated on the Pension Book.
- 4.7.5.3 The Pension Book shall state if pension payment is made by direct credit or by cheque (through a nominated bank).
- 4.7.5.4 On renewal of the Pension Book, the old Pension Book shall be retained by the Accountant General.

---

#### **4.7.6 Personal appearance of pensioner**

- 4.7.6.1 Where pension is paid through direct credit transfer, the pensioner shall personally visit the relevant DAO/AG/AGPR every three months. In the case of payment by cheque, he/she shall personally present the pension cheque at the designated bank branch.
- 4.7.6.2 The above rule can be relaxed by the Accountant General or his/her delegated authority where the pensioner is ill or disabled or for medical reason incapable of managing his/her own affairs. In such circumstances the pensioner shall receive his/her pension through a representative upon production of a life certificate signed by a delegated government officer.
- 4.7.6.3 A pensioner is exempted from personal appearance if he/she draws his/her pension through a representative agent who has executed a bond to refund overpayments and produce at least once a year a life certificate signed by a delegated government officer.
- 4.7.6.4 If a pensioner does not appear personally or produce a life certificate, as described in above Direction 4.7.6.1 to 4.7.6.3, his/her further pension payment shall be stopped by the DAO/AG/AGPR until such time the pensioner comply with the above Directions.

#### **4.7.7 Overseas pension payment**

- 4.7.7.1 Where a pensioner is resident in another country, the pension payment shall be made through the Foreign Mission concerned under such general or special orders as the Government may issue in this behalf.
- 4.7.7.2 A pensioner may also elect to draw his/her pension at designated bank branch of NBP through a duly authorised agent who must either produce a certificate signed by a delegated government officer on each occasion, that the pensioner was alive on the date to which his/her pension is claimed, or execute a bond to refund overpayments and produce such certificate at least once a year.

#### **4.7.8 Gratuities**

- 4.7.8.1 Gratuities shall only be paid on the authority received through the Accountant General, to whom the sanction is communicated in writing by the delegated authority.
- 4.7.8.2 Gratuities shall either be paid by direct credit or by cheque to the person on his/her personal appearance, as described in above Sections.

---

**4.7.9 Undrawn pensions and arrears**

- 4.7.9.1 Unless the Government by general or special orders directs otherwise, a pension remaining undrawn for more than one year shall cease to be payable. If the pensioner afterwards appears personally, with his/her Pension Book and National Identity Card, the DAO or the AG who authorised the pension payment in the first instance may make the payment after satisfying himself/herself that the pension is payable.
- 4.7.9.2 If a pension remains undrawn for three years, it cannot be paid without the authority of the Accountant General.
- 4.7.9.3 A gratuity payment order shall remain in force for one year only, from the date of its issue.

**4.7.10 Death of pensioner**

- 4.7.10.1 A pension can be drawn for the day of the pensioner's death.
- 4.7.10.2 On the death of a pensioner, payment of any arrears actually due may be made to his/her heirs, provided that they apply within one year of his/her death. They cannot be paid thereafter without the sanction of a delegated authority, to be obtained through the Accountant General.
- 4.7.10.3 If the arrears do not exceed Rs 5,000 and the case presents no peculiar features, the Accountant General may approve the arrears on his/her own authority.
- 4.7.10.4 Any person claiming as the heir of a deceased pensioner shall be required to produce the pensioner's Pension Book and the copy of the order in which the sanction to the pension was communicated to the heir.



4.7.11 Processing of pension application flowchart

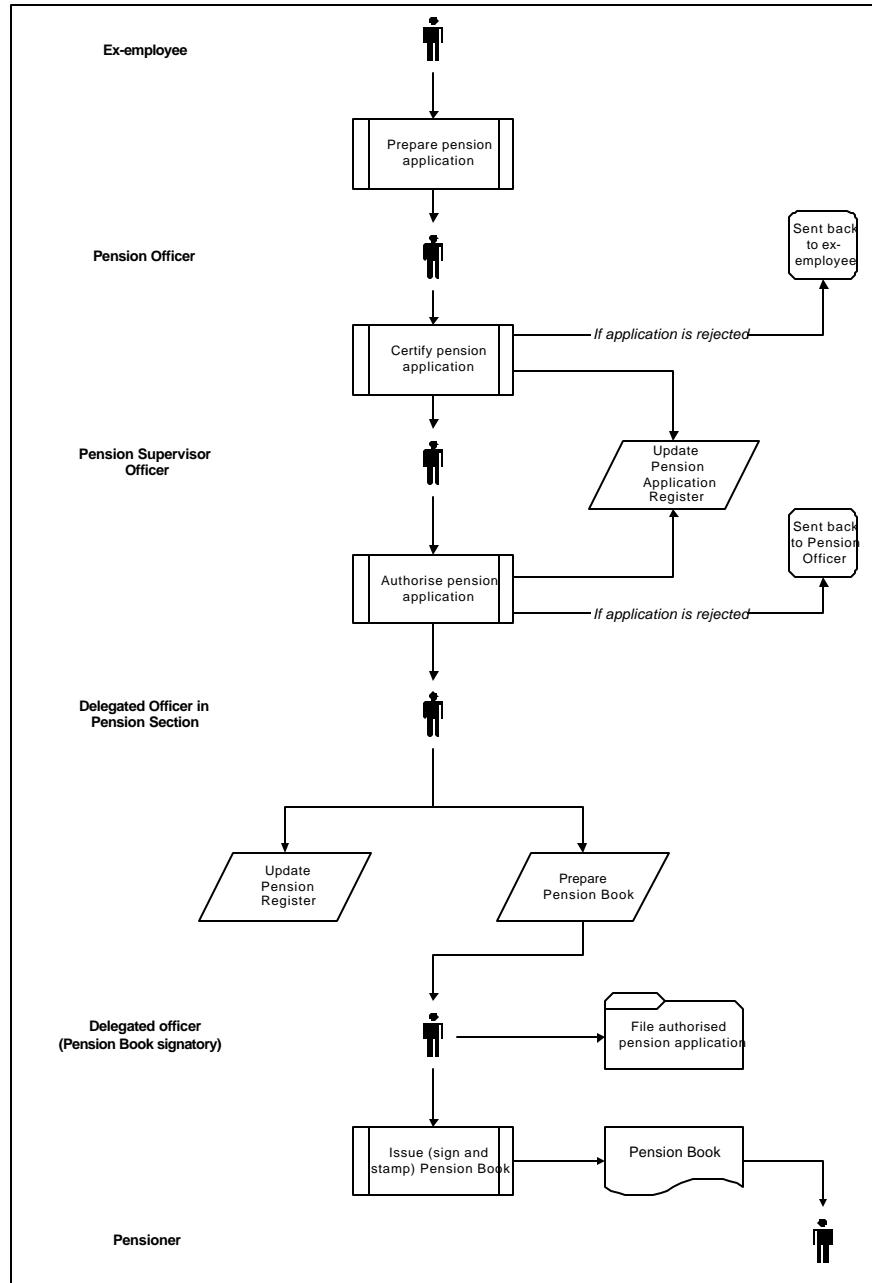

---

#### **4.7.12 Processing of pension application**

4.7.12.1 The concerned employee shall prepare the pension application, in prescribed form, (form 4N) and submit it to the Pension Section of the DAO/AG/AGPR office.

4.7.12.2 In the Pension Section, the pension officer shall record the pension application in the "Pension Application Register". The officer shall certify pension application and ensure that:

- the person who's pension application is submitted is eligible for pension payments
- the pension application has been sanctioned, is complete and duly signed by both the relevant authority and the ex-employee
- any supporting documents required with the application are attached and duly signed by both the relevant authority and the ex-employee
- calculation of pension payment is in accordance with the Government rules and regulations.

4.7.12.3 If the pension officer is not satisfied with the pension application, the officer shall not approve the application and refer the application to his/her next higher authority along with his/her specific observations.

4.7.12.4 On rejection the officer shall return the application and all supporting documents to the ex-employee who submitted the application, with written reasons for refusal.

4.7.12.5 Once the pension officer is satisfied with the application, he/she shall sign and date the application, update the Pension Application Register and pass on the application to the pension supervisor officer.

4.7.12.6 The pension supervisor officer shall authorise the pension application and ensure that:

- the previous phases of pension application preparation and certification were properly carried out
- the pension calculation satisfies government rules and regulations.

4.7.12.7 If the pension supervisor officer is not satisfied with the pension application, the officer shall not authorise the application and return the application and all supporting documents to the pension officer who certified the application, with written reasons for refusal.

4.7.12.8 If the pension officer is able to rectify the reasons for refusal, the officer shall rectify it and resubmit to the pension supervisor officer. If the pension officer is not in the position to rectify the reasons for

---

refusal, he/she shall return the application and all supporting documents to the ex-employee who originally submitted the application to the office, with written reasons for refusal.

- 4.7.12.9 Once the ex-employee rectifies the reasons for refusal, he/she shall re-submit the application to the office of the DAO/AG/AGPR.
- 4.7.12.10 Once the pension supervisor officer is satisfied with the application, he/she shall authorise the original application, sign and date the pension application and pass on the application to the relevant officer for preparation of "Pension Book". At the same time the authorised officer shall update the Pension Application Register.
- 4.7.12.11 On the basis of an authorised pension application, the delegated officer in the Pension Section shall update the "Pension Register" and prepare the Pension Book.
- 4.7.12.12 A delegated officer (Pension Book signatory) shall review the Pension Book, along with the authorised pension application, and, once satisfied, shall sign and stamp the Pension Book. The officer shall then file the authorised pension application.
- 4.7.12.13 The pensioner shall be notified about the issue of the Pension Book, which shall be personally collected by the pensioner. A copy of the notification is also sent to the relevant DDO who submitted the original pension application.

4.7.13 Processing of pension payment flowchart

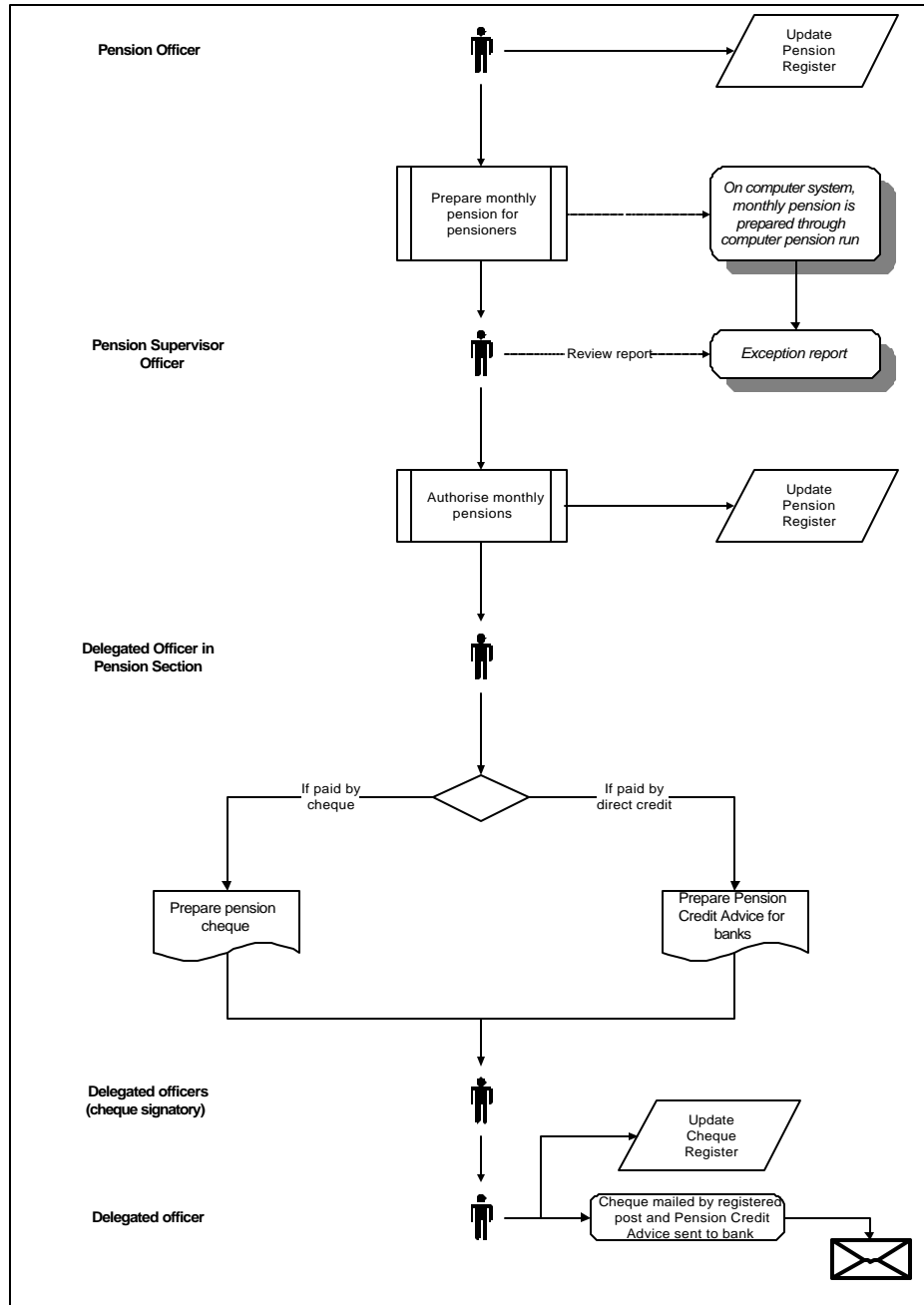

---

**4.7.14 Processing of pension payment**

- 4.7.14.1 On the basis of the Pension Register, the pension officer in the Pension Section of the DAO/AG/AGPR office shall prepare a monthly schedule of pensioner's payments by the 26<sup>th</sup> of a month.
- 4.7.14.2 Where a computerised system is used, the monthly schedule is automatically produced as part of the monthly pension run. The computerised pension system will also produce an exception report in relation to the pensioner's payment (e.g. monthly pension exceeding a set amount, variation between current month and last month).
- 4.7.14.3 The pension supervisor officer shall review and verify the monthly schedule of pensioner's payment and authorise it for payment once he/she is satisfied with the pension schedule. At the same time the officer shall update the Pension Register.
- 4.7.14.4 Once the monthly pension schedule is authorised for payment, a delegated officer (independent of the pension officer and the pension supervisor officer) shall prepare the "Pension Credit Advice" (form 4M) for direct credit payments.
- 4.7.14.5 Where pension payment is paid by cheque, the delegated officer shall prepare pension cheques as per Directions laid down in Sections 4.2.9, 4.5.8 and 4.7.4.
- 4.7.14.6 Two delegated officers (signatories) shall sign the Pension Credit Advice and the pension cheques.
- 4.7.14.7 The Pension Credit Advice shall be sent to the bank, by a delegated officer, on the last working day of the month for direct credit into the pensioner's bank account on the same day.
- 4.7.14.8 Where pension payment is made by cheque, it should either be despatched through registered post 2 working days before the due date or handed to the pensioner on the due date.
- 4.7.14.9 The relevant officer who prepares and dispatches the cheques shall also prepare the "Pension Advice Note" (form 4L) once the cheque is signed by the cheque signatory officers and before it is dispatched to the pensioner. The Pension Advice Note shall be sent to the bank on the last working day of the month.
- 4.7.14.10 The delegated officer who prepares the cheque shall enter the cheque details in the "Cheque Register" (form 4J).
- 4.7.14.11 A copy of the Pension Credit Advice and the Pension Advice Note shall be sent to the Account Section.

---

4.7.14.12 Where pension payment is paid incorrectly, the adjustment shall be made in next month's pension payment or as agreed with the Accountant General.

#### **4.7.15 Recording of pension expenditure**

4.7.15.1 In the Account Section the delegated officer shall record details of pensions, as stated on the authorised Pension Advice Note and Pension Credit Advice sent by the Pension Section, in the Sub Ledger and Appropriation Control Register as per directions laid down in Section 4.4 "Accounting for Expenditures".

4.7.15.2 Once the pension expenditure is recorded the Pension Advice Note and Pension Credit Advice shall be filed by the officer.

4.7.15.3 Where a pension cheque is not received by the pensioner or pension is not transferred to his/her bank account, the recovery action shall be carried out as per Section 4.2.12 "Stop payment and replacement cheque".

#### **4.7.16 Consolidation of pension expenditure**

4.7.16.1 The delegated officer in the Account Section of the DAO/AG/AGPR office shall consolidate the expenditures, on monthly basis, from the entries in the General Ledger and include them in the Monthly Accounts. Also refer to Section 4.4 "Accounting for Expenditures".

#### **4.7.17 Reporting of pension expenditure**

4.7.17.1 Pension expenditures shall be reported to the Accountant General as part of the Monthly Accounts prepared by the District Accounts office.

4.7.17.2 From the Monthly Accounts received from the District Accounts offices, the Accountant General shall produce the Consolidated Monthly Accounts for the Provincial Government or the Federal Government, as the case may be.

#### **4.7.18 Recording, consolidation and reporting of pension expenditure flowchart**

4.7.18.1 The flowchart as shown in Section 4.5.14 "Recording, consolidation and reporting of expenditure flowchart" is also applicable in pension expenditure. The main difference is that the Pension Advice Note and Pension Credit Advice replaces the paid claim voucher as the source document for recording purposes.

---

**4.7.19 Reconciliation of pension expenditure**

- 4.7.19.1 The Bank will send the “Bank Return” to the Account Section, where a delegated officer shall check the Bank Return with the copy of the Pension Advice Note and Pension Credit Advice. In respect of the Pension Credit Advice the total will be reconciled with the total appearing on the Bank Return. The officer shall investigate any item which is on the Bank Return but not on the Pension Advice Note and the Pension Credit Advice, and vice versa.
- 4.7.19.2 Items that are on the Pension Advice Note and the Pension Credit Advice but not on the Bank Return usually represent “unpresented cheques” due to timing differences and form part of monthly bank reconciliation. These pension payments should normally be cleared during next month.
- 4.7.19.3 Once the delegated officer in the Account Section is finished with the Bank Returns, these returns should be sent to the officer who prepared the cheque. This officer shall enter the details from the Bank Returns into the Cheque Register and reconcile the cheques issued by the office and cleared by the bank. A report/schedule of this reconciliation shall be sent to the Account Section. It should also indicate those cheques which are not yet cleared by the bank.

**4.7.20 Reporting on pensions**

- 4.7.20.1 When a pension payment is made by cheque, the designated branch of the National Bank of Pakistan at which the cheque is personally presented by the pensioner, shall send a monthly statement, together with their Bank Return to certify that all pensioners paid during the month were alive, and that all pensioner’s Pension Books were stamped for the month.
- 4.7.20.2 A monthly report will be produced by the DAO/AG/AGPR which includes the following information:
- number of pensioners added during the month
  - number of pensioners expired
  - total pension payable and actually paid.

---

## **4.8 General Provident Fund**

### **4.8.1 Introduction**

4.8.1.1 The procedures described in the following regulations shall be applicable to General Provident Fund (GP Fund).

- Provident Funds Act (XIX of 1925)
- General Provident Fund Rules (for Federal and Provincial civil employees).

4.8.1.2 This Section covers GP Fund payments (both advances and final payment) in relation to all employees of the Federal and Provincial Government who are subscribers to the Fund.

4.8.1.3 An employee is compulsory subscribed to the GP Fund from the date of his/her appointment. Monthly subscription is by deduction from the monthly payroll. For employees on foreign service, the monthly subscription is by way of a voucher.

4.8.1.4 A uniform rate of subscription, as advised by the Government, is used for a financial year.

4.8.1.5 Interest and bonus payment shall be regulated in accordance with the General Provident Fund Rules.

### **4.8.2 Advance from GP Fund**

4.8.2.1 A temporary advance from the GP Fund may be granted to a subscriber on certain conditions as laid down in the General Provident Fund Rules.

4.8.2.2 If the subscriber was given an advance from the GP Fund, any further advance may be allowed but only where the previous advance with interest has been repaid. This can be recovered from the amount of the second advance.

4.8.2.3 The advance is repayable in such equal monthly instalment as sanctioned by a delegated authority. The monthly instalment should not be less than 12 and more than 48.

4.8.2.4 A subscriber at his/her option may pay more than one instalment in a month.

4.8.2.5 Recovery may be postponed, on a subscriber's written request, by the delegated authority.



---

4.8.2.6 A non refundable advance may be granted where the subscriber's age is over a certain threshold, as laid down in the General Provident Fund Rules.

4.8.2.7 In all cases the amount of the advance shall not exceed 80% of the balance in the account of the subscriber on the date of application for the grant of advance.

### **4.8.3 Payment by direct credit**

4.8.3.1 All GP Fund payments (advances and final payment) shall be made by credit transfer direct to a bank account nominated by the subscriber. This is the most secure and economical method of payment, and it automatically ensures that subscribers have access to their money promptly. Moreover, direct credit has tangible advantages, over payment by cheque or cash, against risks of theft or fraud.

4.8.3.2 For the purpose of enabling GP Fund payments to be made by direct credit, the subscriber shall furnish to the DAO/AG/AGPR a payment authority nominating the account with a bank to which payment may be credited. The authority shall specify the name and branch of the bank, the full title of the nominated account and the account number. In most cases this bank account would be the same which is used for employee's salary payments.

### **4.8.4 GP Fund monthly deductions from salary**

4.8.4.1 A compulsory deduction, at a fixed rate (amount) set by the Government, shall be made from the monthly salary of an employee.

4.8.4.2 The Payroll Section shall ascertain the monthly deductions to be made (which should normally be the same throughout a financial year) from salary.

4.8.4.3 The GP Fund supervisor officer in the GP Fund Section shall update the "GP Fund Ledger" on the basis of the monthly deduction made from the salary.

4.8.5 Processing of GP Fund payment flowchart

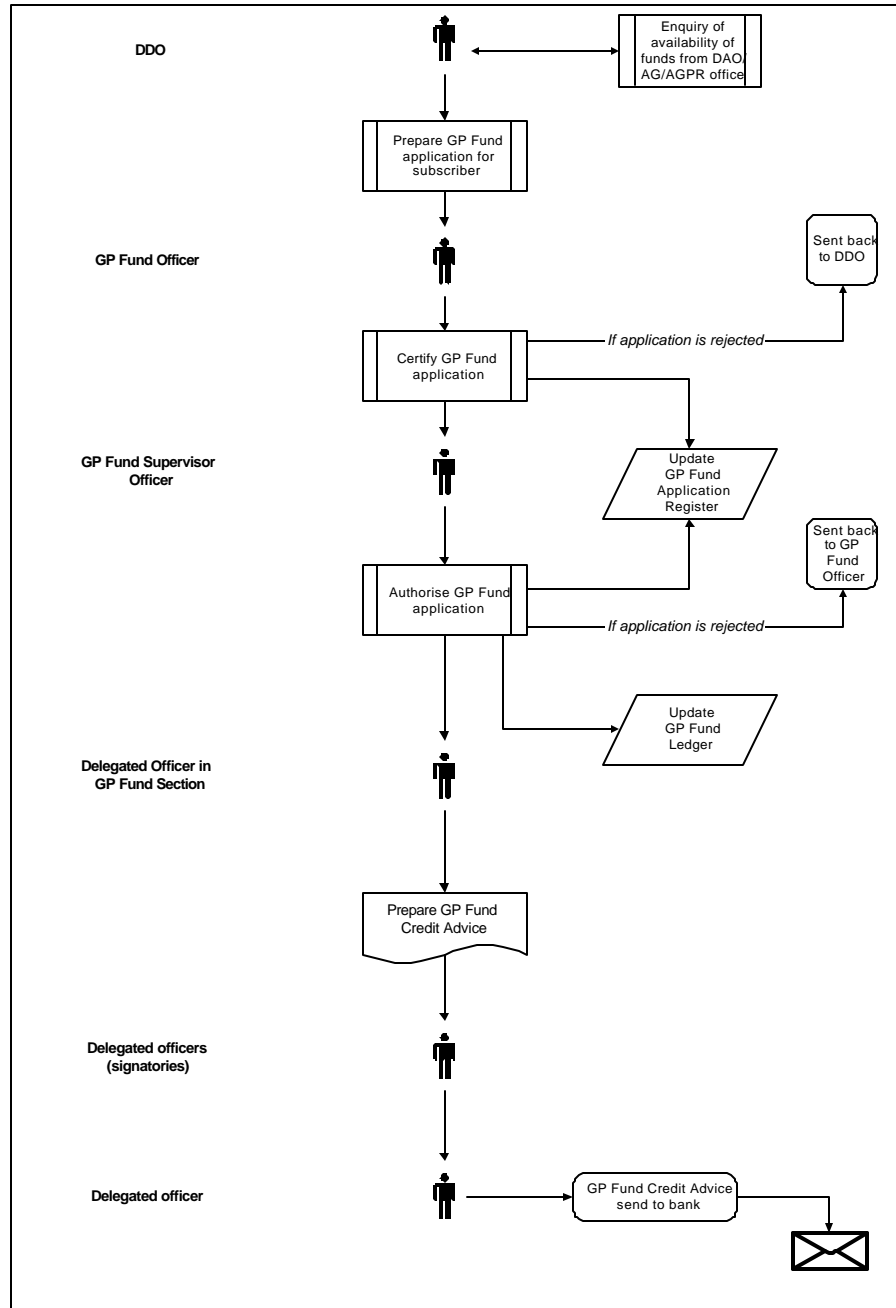

---

#### **4.8.6 Processing of GP Fund payment**

4.8.6.1 The relevant DDO shall check the available balance of the subscriber's GP Fund from his/her Monthly Salary Statement.

4.8.6.2 The relevant DDO shall prepare the GP Fund application of the subscriber, in prescribed form, on an application form (form 4O) and submit it to the GP Fund Section of the DAO/AG/AGPR office.

4.8.6.3 The application form shall have the words "GP Fund Advance Payment" or "GP Fund Final Payment" written or stamped prominently upon the face of the application.

4.8.6.4 Where the application is in relation to final payment and no GP Fund advances are outstanding, a certificate shall be produced by the subscriber that no advances are outstanding. This certificate shall be approved by the DDO by checking with the Last Pay Certificate of the employee.

4.8.6.5 In the GP Fund Section, the GP Fund officer shall record the GP Fund application in the "GP Fund Application Register" (form 4P) and shall state whether the application is in relation to an advance or a final payment. The officer shall verify the GP Fund application and ensure that:

- the subscriber whose GP Fund application is submitted is eligible for GP Fund payments (both for advance and final payment)
- for final payment, any advance already taken has been adjusted in the application
- the GP Fund application is complete and duly signed by both the relevant DDO and the subscriber
- any supporting documents required with the application are attached and duly signed by both the relevant DDO and the subscriber
- for advance payment, it meets the criteria set out in Section 4.8.2 "Advance from GP Fund"
- the calculation of GP Fund payment is in accordance with the Government rules and regulations.

4.8.6.6 If the GP Fund officer is not satisfied with the GP Fund application, the officer shall not approve the application and shall refer the application to his/her next higher authority along with his/her specific observations.

- 
- 4.8.6.7 On rejection the officer shall return the application and all supporting documents to the DDO who submitted the application, with written reasons for refusal.
- 4.8.6.8 Once the GP Fund officer is satisfied with the application, he/she shall sign and date the application, update the GP Fund Application Register and pass on the application to the GP Fund supervisor officer.
- 4.8.6.9 The GP Fund supervisor officer shall authorise the GP Fund application and ensure that:
- the amount (fund) is available in the subscriber's GP Fund account
  - the previous phases of GP Fund application preparation and certification were properly carried out
  - the GP Fund calculation conforms to government rules and regulations.
- 4.8.6.10 If the GP Fund supervisor officer is not satisfied with the GP Fund application, the officer shall not authorise the application and shall return the application and all supporting documents to the GP Fund officer who certified the application, with written reasons for refusal.
- 4.8.6.11 If the GP Fund officer is able to rectify the reasons for refusal, the officer shall rectify it and resubmit to the GP Fund supervisor officer. If the GP Fund officer is not in the position to rectify the reasons for refusal, he/she shall return the application and all supporting documents to the DDO who originally submitted the application to the office, with written reasons for refusal.
- 4.8.6.12 Once the DDO in the department/entity rectifies the reasons for refusal, he/she shall re-submit the application to the office of the DAO/AG/AGPR.
- 4.8.6.13 Once the GP Fund supervisor officer is satisfied with the application, he/she shall authorise the original application, sign and date the GP Fund application for payment. At the same time the GP Fund supervisor officer shall update the GP Fund Application Register and the "GP Fund Ledger".
- 4.8.6.14 Where final payment is authorised, the GP Fund supervisor officer shall close the GP Fund account of the subscriber in the GP Fund Ledger.
- 4.8.6.15 On the basis of an authorised GP Fund application, a delegated officer (independent of the GP Fund officer and the GP Fund supervisor officer) shall prepare the "GP Fund Credit Advice" (form 4M) for direct credit payments.
-

---

4.8.6.16 Two delegated officers (signatories) shall sign the GP Fund Credit Advice.

4.8.6.17 The GP Fund Credit Advice shall be sent to the bank by a delegated officer for direct credit into the subscriber's bank account.

4.8.6.18 A copy of the GP Fund Credit Advice shall be sent to the Account Section.

#### **4.8.7 Recording of GP Fund expenditure**

4.8.7.1 In the Account Section of the DAO/AG/AGPR office, the delegated officer shall record details of the GP Fund, as stated on the authorised GP Fund Credit Advice sent by the GP Fund Section, in the Sub Ledger as per the directions laid down in Section 4.4 "Accounting for Expenditures".

4.8.7.2 Once the GP Fund expenditure is recorded the GP Fund Credit Advice shall be filed by the officer.

4.8.7.3 Where the GP Fund is not transferred to a subscriber's bank account, the recovery action shall be carried out as per Section 4.2.12 "Stop payment and replacement cheque".

#### **4.8.8 Consolidation of GP Fund expenditure**

4.8.8.1 The delegated officer in the Account Section of the DAO/AG/AGPR office shall consolidate the expenditures, on a monthly basis, from the entries in the General Ledger and include them in the Monthly Accounts. Also refer to Section 4.4 "Accounting for Expenditures".

#### **4.8.9 Reporting of GP Fund expenditure**

4.8.9.1 GP Fund expenditure shall be reported to the Accountant General as part of the Monthly Accounts prepared by the District Accounts office.

4.8.9.2 From the Monthly Accounts received from the District Accounts offices, the Accountant General shall produce the Consolidated Monthly Accounts for the Provincial Government or the Federal Government, as the case may be.

4.8.9.3 The GP Fund Section shall produce an annual statement of GP Fund account of each subscriber. A copy of this annual statement shall be given to the subscriber by 31 August.

---

**4.8.10 Recording, consolidation and reporting of GP Fund expenditure flowchart**

4.8.10.1 The flowchart as shown in Section 4.5.14 ‘Recording, consolidation and reporting of expenditure flowchart’ is also applicable to GP Fund expenditure. The main difference is that the GP Fund Credit Advice replaces the paid claim voucher as the source document for recording purposes.

**4.8.11 Reconciliation of GP Fund expenditure**

4.8.11.1 The Bank will send the ‘Bank Return’ to the Account Section, where a delegated officer shall check the Bank Return with the copy of the GP Fund Credit Advice. The officer shall investigate any item which is on Bank Return but not on GP Fund Credit Advice, and vice versa.

4.8.11.2 Items that are on the GP Fund Credit Advice, but not on the Bank Return, usually represent ‘unpresented items’ due to timing differences and form part of monthly bank reconciliation. These GP Fund payments should normally be cleared during next month.

---

## 4.9 Contractor/Work Payments

### 4.9.1 Introduction

4.9.1.1 This section deals with payments specific to Public Works Department only.

4.9.1.2 Payments to contractors will cover payments in relation to Civil Work and Irrigation, Navigation, Embankment and Drainage Works under the administrative control of the Public Works Department.

4.9.1.3 All works and repairs to government buildings and works and repairs in connection with sanitary, water supply and electric installations to government buildings, shall be carried out by the Works Department, except in special cases under the order of the Government.

4.9.1.4 No work should be commenced or liability incurred until:

- administrative approval has been obtained from the authority appropriate in each case
- sanction, either special or general, of delegated authority has been obtained authorising the expenditure
- a detailed designed and estimate has been sanctioned by a delegated authority
- funds to cover the expenditure during the year have been provided.

4.9.1.5 The powers delegated to various authorities to accord administrative approval and sanction expenditure in relation to works are regulated by the orders contained in the Book of Financial Powers and other special orders contained in the respective departmental regulations.

4.9.1.6 Where work is to be carried in cases of emergency, the officer may proceed to carry out the necessary work, subject to the condition that he/she immediately inform the Executive Engineer and the Accountant General that he is incurring an unauthorised expenditure. He/she shall also state the reasons for the emergency and give an approximate amount of the expenditure which he/she is likely to incur.

4.9.1.7 To facilitate the preparation of estimates and to serve as a guide in setting rates in connection with contract agreements, a schedule of rates for each kind of work commonly undertaken shall be maintained in each locality and kept up to date. These rates shall be approved by a delegated authority.

4.9.1.8 Preparation of estimates for work shall be in accordance with the rules and instructions contained in the Central Public Works Account Code and rules and instructions issued by the Department.

4.9.1.9 The following key internal controls must be observed in processing of contractor/work payments.

- all bills shall be signed by the contractor
- all cheques shall be signed by the Executive Engineer and another delegated officer
- all cheques to contractors and Daily Advice Note to banks shall be sent by a delegated officer (on behalf of the Executive Engineer)
- bank returns from the banks shall be received by the Divisional Account Officer (on behalf of the Executive Engineer)

4.9.1.10 Also refer to Central Public Works Account (CPWA) code for works expenditures.

#### **4.9.2 Work done for other departments**

4.9.2.1 Where the Works Department undertakes work on behalf of another administrative department, the employing department shall inform the Works Department the sanctioned grant within which the expenditure is to be incurred. This is in order to ensure that the Works Department does not exceed the sanctioned funds without the written authority of the employing department.

4.9.2.2 The Works Department shall be responsible not only for seeing that the funds placed at its disposal is not exceeded but also that any anticipated savings are notified and surrendered in time.



4.9.3 Processing of payment to supplier and contractors flowchart

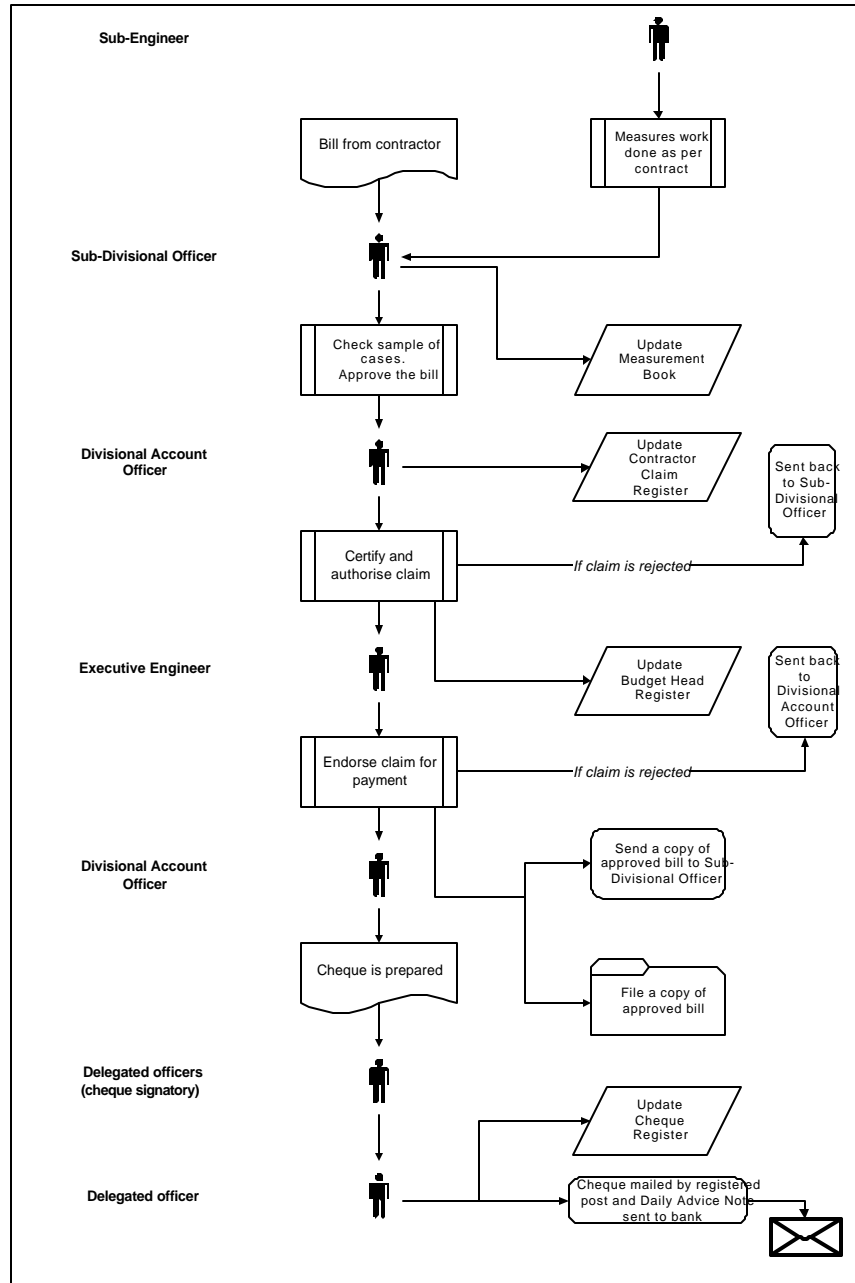

---

#### 4.9.4 Processing of payment to supplier and contractors

- 4.9.4.1 The Sub-Engineer shall measure all work done by the contractor and ensure that it is as per contract with the contractor and in accordance with the schedule of rates.
- 4.9.4.2 The Sub-Engineer shall also verify supplies received and ensure that it is as per contract with the supplier.
- 4.9.4.3 The Sub-Engineer shall submit the details of the supplies and the work done to the Sub-Divisional Officer on a weekly basis along with all supporting documents.
- 4.9.4.4 The Sub-Divisional Officer shall record the detail of all the work done into the "Measurement Book".
- 4.9.4.5 The Sub-Divisional Officer shall check a sample of the work done. The sample is selected according to the rules and guidance issued by the Department.
- 4.9.4.6 All bills shall be prepared on a "Contractor/Supplier Bill" (form 4Q), signed by the contractor and submitted to the Sub-Divisional Officer with all supporting documents.
- 4.9.4.7 The Sub-Divisional Officer shall check the bill against the Measurement Book and approve the bill. The officer shall ensure that:
- the supply or work has been received or performed
  - the bill is prepared on an authorised form, is correct, complete, signed by the contractor and supported by relevant documents
  - the budget against the relevant expenditure head is not exceeded.
- 4.9.4.8 The Sub-Divisional Officer shall enter on the bill the account number and the name of the expenditure head to which the expenditure is to be charged.
- 4.9.4.9 A duplicate bill shall not be issued except where the original has been lost or destroyed. A duplicate bill shall have the word "DUPLICATE" written or stamped prominently upon the face of the bill. Where a duplicate bill is raised, the Sub-Divisional Officer shall state the reasons for its issue.
- 4.9.4.10 Payment for supplies in advance shall be made as per directions laid down in Section 4.2.15 "Payment for supplies in advance". The bill must be prominently stamped "PAID IN ADVANCE" and the Sub-Divisional Officer shall state the nature or terms or conditions of the contract under which payment is to be made in advance.

- 
- 4.9.4.11 The Sub-Divisional Officer shall sign and date the bill and all supporting documents. Once the bill is approved, it shall be submitted to the Divisional Account Officer with all supporting documents.
- 4.9.4.12 The Divisional Account Officer shall record the claim submitted in the “Contractor Claim Register”.
- 4.9.4.13 The Divisional Account Officer shall certify and authorise the bill and ensure that:
- the payments which are claimed are for valid expenditure that has been duly approved and that there is no reason to believe that the bill should not be paid
  - administrative approval has been obtained (and attached) from the delegated authority
  - the bill is complete, duly approved and signed by the relevant Sub-Divisional Officer
  - supporting documents accompanying the bill are valid, duly approved and signed by the relevant Sub-Divisional Officer
  - the relevant Sub-Divisional Officer who has approved and signed the bill and supporting documents, is an officer authorised to approve such claims and has not exceeded his/her authority
  - the claim must not have been previously paid (specially in respect of claims issued on a duplicate bill) and must identify the head of expenditure to which the amount is chargeable
  - the funds are lawfully available to pay the bill.
- 4.9.4.14 If the Divisional Account Officer requires additional information or documents, he/she shall obtain them from the relevant Sub-Divisional Officer.
- 4.9.4.15 The Divisional Account Officer shall not authorise those claims which do not relate to his/her division or jurisdiction, or, for which a written direction has not been received from the Accountant General.
- 4.9.4.16 If the Divisional Account Officer is not satisfied with the claim, the officer shall not authorise the bill and shall return the bill and all supporting documents to the officer who submitted the claim, with written reasons for refusal.
- 4.9.4.17 Once the Divisional Account Officer is satisfied with the claim, he/she shall sign and date the original bill and pass on the bill to the Executive Engineer. At the same time he/she shall update the “Appropriation Control Register” and the “Contractor Claim Register”.
-

- 
- 4.9.4.18 The Executive Engineer shall review the claim both from a technical and an administrative viewpoint and ensure that the bill bears valid evidence that all phases of checking, approving, certification and authorisation have been properly carried out.
- 4.9.4.19 If the Executive Engineer is not satisfied with the claim, he/she shall not endorse the bill and shall return the bill and all supporting documents to the Divisional Account Officer, with written reasons for refusal.
- 4.9.4.20 If the Divisional Account Officer is able to rectify the reasons for refusal, the officer shall rectify it and resubmit to the Executive Engineer. If the Divisional Account Officer is not in the position to rectify the reasons for refusal, he/she shall return the bill and all supporting documents to the Sub -Divisional Officer who originally submitted the bill, with written reasons for refusal.
- 4.9.4.21 Once the relevant Sub-Divisional Officer rectifies the reasons for refusal, the officer shall re-submit the bill to the Divisional Account Officer.
- 4.9.4.22 Once the Executive Engineer is satisfied with the claim, he/she shall endorse the original bill for payment, sign and date the bill and pass on the original bill to the Divisional Account Officer for issue of cheque.
- 4.9.4.23 At the same time the Executive Engineer shall file a copy of endorsed bill and shall send another copy of the endorsed bill to the relevant Sub-Divisional Officer.
- 4.9.4.24 The Divisional Account Officer shall update the “Contractor Claim Register” and prepare the cheque on the basis of original bill and as per directions laid down in Section 4.2.9, ‘Issue of payment’.
- 4.9.4.25 The cheque signatory officers (Executive Engineer being one of two officers) shall sign the cheque as per directions laid down in Sections 4.2.9 and 4.5.8.
- 4.9.4.26 The Divisional Account Officer shall sent the cheque to the relevant DAO/AG/AGPR. The DAO/AG/AGPR will maintain an appropriation register and will check and enter the cheque amount against the relevant budget grant. The DAO/AG/AGPR will not endorse the cheque which exceeds the budget grant.
- 4.9.4.27 Once the cheque is endorsed the DAO/AG/AGPR shall return the endorsed cheque to the Divisional Account Officer.
- 4.9.4.28 A delegated officer (independent of the Divisional Account Officer) shall mail the signed cheque to the payee by registered post.
-

---

The officer shall also prepare the "Daily Advice Note" (form 4L) once the cheque is signed but before it is dispatched to the payee. The Daily Advice Note shall be sent to the bank.

4.9.4.29 The delegated officer who prepares the cheque shall enter the cheque details in the "Cheque Register" (form 4J).

4.9.4.30 A copy of the Daily Advice Note shall also be sent to the Divisional Account Officer.

#### **4.9.5 Payments for works done through Local Bodies**

4.9.5.1 When the maintenance of any Government buildings or roads is entrusted to the Local Body, the payment processes and procedures shall be the same as for work done by a contractor and described in previous Section.

4.9.5.2 If lump sum payments have been agreed with the Local Body, each payment must be supported by a certificate from the Sub-Divisional Officer that the work has been done in accordance with the rules and conditions agreed with the Local Body.

#### **4.9.6 Recording of contractors expenditure**

4.9.6.1 An account officer (where practicable, independent of the Divisional Account Officer) shall record details of expenditure, as per endorsed original bill, in the Sub Ledger in accordance with directions laid down in Section 4.4.6

4.9.6.2 The Divisional Accounts Officer shall perform the required entries in the Appropriation Control Register, including the reversal of any previously established commitments in accordance with the Directions laid down in Section 4.4.2.

4.9.6.3 Once an expenditure is recorded the original bill and all supporting documents shall be filed by account officer.

#### **4.9.7 Consolidation of contractors expenditure**

4.9.7.1 The Divisional Account Officer shall consolidate the expenditures, on a monthly basis, from the entries in the General Ledger and include them in the Monthly Accounts. Also refer to Section 4.4 "Accounting for Expenditures".

#### **4.9.8 Reporting of contractors expenditure**

4.9.8.1 The Divisional Account Officer shall send the Monthly Accounts to the relevant DAO office or the AG office. A copy of the Monthly Accounts is also sent to the Director of Accounts (Works).

---

4.9.8.2 Where the DAO office receive the monthly accounts, the expenditures are incorporated in the Monthly Accounts prepared for the District Accounts office.

4.9.8.3 From the Monthly Accounts received from the District Accounts office/Divisional Account Officer, the Accountant General shall produce the Consolidated Monthly Accounts for the Provincial Government or the Federal Government, as the case may be.

#### **4.9.9 Recording, consolidation and reporting of contractors expenditure flowchart**

4.9.9.1 The flowchart as shown in Section 4.5.14 “Recording, consolidation and reporting of expenditure flowchart” is also applicable in contractors expenditure.

#### **4.9.10 Reconciliation of contractors expenditure**

4.9.10.1 The Divisional Account Officer shall prepare a bank reconciliation as laid down in Chapter 6. The bank reconciliation will enable to reconcile expenditure payments with the bank.

4.9.10.2 The Bank will send the “Bank Return” to the Divisional Account Officer who shall check the Bank Return with the copy of the Daily Advice Note. The officer shall investigate any item which is on the Bank Return but not on the Daily Advice Note, and vice versa.

4.9.10.3 Items that are on the Daily Advice Note but not on the Bank Return usually represent “unpresented cheques” due to timing differences and form part of a monthly bank reconciliation.

4.9.10.4 Once the Divisional Account Officer is finished with the Bank Returns, these returns should be sent to the officer who prepares the cheque. This officer shall enter the details from the Bank Returns into the Cheque Register and reconcile the cheques issued by the office and cleared by the bank. A report/schedule of this reconciliation, which should also indicate those cheques that are not yet cleared by the bank, shall be sent to the Divisional Account Officer.

---

## **4.10 Loans And Advances**

### **4.10.1 Introduction**

- 4.10.1.1 Loans and advances made by the Government are classified according to the items included under 'Loans and Advances' in the chart of accounts. These include both long-term loan and advances and short-term loan and advances.
- 4.10.1.2 Long term loans in the Federal Government include interest bearing loans to Provincial Governments, local bodies and other public sector organisations and individuals. These also include interest bearing and non-interest bearing loans and advances to government employees. Short term interest free advances are available to government employees on tour or transfer, or at times, treatment abroad. The provincial loans and advances are also divided in a similar manner.
- 4.10.1.3 The total budget grant of all interest bearing loans and advances requires the approval of the Government. The financial delegations in relation to loans and advances is set out in the 'Delegation of Financial Powers'.
- 4.10.1.4 Where the conditions for repayment of loans and advances are set out by special Acts or rules of the Government, then those conditions shall apply (e.g. loans to Provincial Governments, advances to cultivators). Borrowers are required to adhere strictly to the terms settled for the loans and advances made to them.
- 4.10.1.5 Interest rates and the basis of interest calculation shall be determined by the Government for any particular loan or class of loans. Unless otherwise specified, simple interest shall be used. Loans shall bear interest from (and including) the date of advance, up to (but not including) the date of repayment.

### **4.10.2 Loan and advances to Provincial Governments**

- 4.10.2.1 Recoveries of loans granted to Provincial Governments are governed by special orders of the Government which must specify the terms and conditions under which loans are to be granted and repaid.

### **4.10.3 Loans and advances to Government employees**

- 4.10.3.1 Unless otherwise specified, loans and advances may be granted to Government employees who are permanent, and in special cases, to temporary Government employees as prescribed in GFR.

---

4.10.3.2 The approval of a loans and advances to a Government employee shall only be given by a delegated authority, independent to the applicant.

4.10.3.3 Simple interest, at a rate determined by the Government, shall apply to all loans and advances made to Government employees, unless specific exemption is provided by the Government. Interest shall be calculated on the outstanding balance of the loan or advance on the last day of each month. If an advance is drawn in more than one instalment then the interest rate used will be the rate prevailing on the date of the first instalment.

4.10.3.4 If a Government employee transfers into the jurisdiction of another DAO/AG/AGPR then the loans and advances and monthly instalments specified in the employee's last pay certificate shall be communicated by the DAO/AG/AGPR office to the DAO/AG/AGPR office to which the employee has transferred.

4.10.3.5 Advances made out of a Government employee's General Provident Fund are referred to in Section 4.8.2 of this Chapter.

4.10.3.6 If a Government employee elects not to claim interest on the GP fund he/she is entitled to interest free advances for the purchase of a house or a motor vehicle.

#### **4.10.4 Housing advances to Government employees**

4.10.4.1 This section applies to advances given to Government employees for the construction of new houses, purchase of a house or apartment or renovation of a house or apartment already owned by the Government employee.

4.10.4.2 Applications for housing advances by Government employees may be approved by delegated authorities established within each of the ministries, subject to the delegations set out in the "Delegation of Financial Powers" and after obtaining the Fund Availability Certificate. The Government employee must satisfy the delegated authority that he/she has legal title to the land upon which the house is, or will be, built.

4.10.4.3 A delegated authority may grant housing advances to Government employees subject to the following conditions:

- a certificate is produced by the Principal Accounting Officer or delegate to the effect that a disciplinary inquiry is not underway for that applicant
- in the case of temporary officers, at least 10 years of continuous service has been attained and security is provided by two



---

permanent Government employees, released when the house has been constructed and mortgaged to the Government

- where the land has already been acquired by the Government employee, that the land be mortgaged to the Government with the house
- that the applicant proves, by way of certificate from an appropriate authority (e.g. house building society, CDA) that the land has been allotted to him/her
- that the Government employee is not likely to retire before full recovery of the amount can be made.

4.10.4.4 For advances given for the purchase of houses or apartments, the Government employee shall execute and register the mortgage deed/lease in the prescribed form, within 3 months of purchase, as security for repayment of the advance.

4.10.4.5 In the case of purchase of an apartment, the Government employee shall obtain surety or other legally binding proof of ownership, from the concerned construction agency.

4.10.4.6 Repayments of housing advances shall commence from 4th month of pay after the payment of the final instalment by the Government. Repayments shall be of such amount to ensure recovery of the advance is made before retirement age. Unless otherwise specified in the loan agreement, repayments shall be made over the following periods:

- 10 years (120 instalments) for gazetted Government employees
- 20 years (240 instalments) for non-gazetted Government employees

4.10.4.7 The amount advanced to a Government employee shall not exceed the equivalent of 36 months of his/her substantive pay.

4.10.4.8 Housing advances shall be recovered by deduction in monthly instalments from the Government employees salary. Where the Government employee would reach retirement before the standard 10 or 20 year interval, monthly repayments must be of such an amount as to ensure full recovery is affected by the date of retirement.

4.10.4.9 Monthly repayments shall cover both the principal and interest amounts due. Interest will not be recovered separately at the end of the repayment period.

---

4.10.4.10 No Government employee shall receive a housing advance in addition to any housing advances that already been given to that employee and are not fully repaid.

#### **4.10.5 Vehicle advances to Government employees**

4.10.5.1 This section applies to advances given to Government employees for the purchase of motor vehicles, including cars and motorcycles.

4.10.5.2 Applications for vehicle advances by Government employees may be approved by delegated authorities established within each of the ministries, subject to the financial delegations set out in the “Book of Financial Powers” and after obtaining the Fund Availability Certificate.

4.10.5.3 The delegated authority may approve a motor car advance of up to the prescribed limit, provided:

- the Government employee draws pay up to the prescribed limit or above
- they are satisfied that it is in the interest of the Government and the employee’s capacity to work that a vehicle be obtained.

4.10.5.4 The delegated authority may approve a motorcycle advance of up to the prescribed limit, provided:

- the Government employee draws pay up to the prescribed limit
- they are satisfied that it is in the interest of the Government and the employee’s capacity to work that a motorcycle be obtained.

4.10.5.5 At the time of drawing the vehicle advance, the Government employee shall execute a mortgage/sales bond (form 4S), providing security for the advance. A copy of this form, signed by the employee, shall be passed on to the Accountant General by the delegated authority. The delegated approving authority, shall keep the mortgage/sales bond in safe custody.

4.10.5.6 The Government employee receiving advance shall complete the acquisition and payment of the vehicle within one month after drawing the advance. If this does not take place, the full amount of the advance, with interest, shall be repaid to the Government.

4.10.5.7 The motor vehicle must be insured against accident, fire and theft.

4.10.5.8 Recovery of the vehicle advance will be made by equal monthly deductions from the employee’s salary, and will commence on the first monthly pay after the advance is drawn. The amount shall be recovered within 60 months or, if nominated by the applicant, a shorter period.

---

4.10.5.9 Monthly repayments shall cover both the principal and interest amounts due. Interest will not be recovered separately at the end of the repayment period.

4.10.5.10 Where the Government employee wishes to sell the motor vehicle, under which advance was given, the approval of the delegated authority who originally approved the advance must first be obtained. Sale proceeds obtained must be used to pay off the balance of the principal owing on the vehicle advance. This direction also applies to cases where the employee is instructed to sell the vehicle (e.g. employee is on long-term leave, retires from service or transfers to a position where possession of a vehicle is not considered necessary).

4.10.5.11 If the Government employee wishes to sell the vehicle and use the sale proceeds to purchase a replacement vehicle, it may be approved by the delegated authority provided:

- the amount outstanding on the advance does not exceed the cost of the replacement vehicle
- the amount outstanding on the advance will be continued to be repaid at the rate previously fixed
- the replacement vehicle will be mortgaged and insured to the Government.

#### **4.10.6 Bicycle advances to Government employees**

4.10.6.1 Advances for bicycles may be granted by a delegated authority within the department/entity of up to Rs 2,000 for Government employees who are either permanent or temporary, provided:

- the employee draws pay not exceeding Rs 1,950
- if the applicant is a temporary employee surety is provided by a permanent employee
- the delegated authority is satisfied the employee will remain in service until recovery of the advance is obtained and the advance will be utilised in the purchase of a bicycle
- a second advance will not be drawn until three years after the expiry of the previous advance.

#### **4.10.7 Interest free advances to Government employees**

4.10.7.1 Interest-free advances may be given to Government employees, upon approval of a delegated authority, in respect of the following:

- upon transfer of the employee, and amount not exceeding one months pay plus travelling allowance

- 
- upon return to Pakistan from an overseas deputation, an amount not exceeding two months pay
  - to Government employees travelling on official duties, an amount sufficient to cover their personal travelling expenses, as provided under the Supplementary Rules and departmental personnel regulations
  - other advances to Government employees for departmental purposes, as regulated by special orders of the Government.

#### **4.10.8 Permanent advances**

4.10.8.1 These are advances granted to officers who are required to make payments before funds are made available to them. Permanent advances are intended to provide to the officer responsible for the advance, sums required for minor contingent expenditures. Refer to Section 4.4 on the procedures applicable to contingent forms of expenditure.

4.10.8.2 The Principal Accounting Officer or delegated authority may approve the granting of permanent advances to officers within the ministry or department, up to an amount advised by the Accountant General.

#### **4.10.9 Recording of loans and advances**

4.10.9.1 Detailed accounts of all loans and advances granted by the Government shall be maintained by the Accountant General, who will monitor their balances and identify any breaches in the terms and conditions of these loans.

4.10.9.2 The delegated officer in Accountant General's office shall record payments and recoveries of loans and advances in the relevant account heads under "Loans and Advances" in the Sub Ledger in accordance with directions laid down in Section 4.4 "Accounting for Expenditures". Also these loans and advances shall be recorded in the Financial Register.

#### **4.10.10 Consolidation of loans and advances**

4.10.10.1 A delegated officer in the Account Section of the DAO/AG/AGPR office shall consolidate the expenditures and recoveries in respect of loans and advances, on a monthly basis, from the entries in the General Ledger and include them in the Monthly Accounts. Also refer to Section 4.4 "Accounting for Expenditures".

---

**4.10.11 Reporting of loans and advances**

- 4.10.11.1 An annual statement showing details of all loan balances, and amounts paid and received under the head “Loans and Advances” shall be prepared by the Accountant General, in accordance with the timetable set down in Chapter 7, “Financial Reporting Procedures”.
- 4.10.11.2 Any default in repayment (either in principal or interest) shall be promptly reported by the Accountant General to the delegated authority who shall then take steps to recover the amount in default.

## **4.11 Overseas Payments**

### **4.11.1 Introduction**

4.11.1.1 The Ministry of Foreign Affairs is a self-accounting entity (also refer to chapter 9) operating an assignment account (also refer to chapter 17) with the National Bank of Pakistan. It is responsible for handling all payments made from foreign missions abroad, including overseas payments incurred by other ministries and departments of the Government.

4.11.1.2 The Financial Advisors of the concerned ministries and departments shall make budgetary provision within the circle of the Ministry of Foreign Affairs for those expenditures their ministry or department will expect to incur in the forthcoming year, including pay, and contingent purchases. These funds (including the relevant foreign exchange component) will then be released by AGPR into the assignment account of the Ministry of Foreign Affairs.

4.11.1.3 At times various ministries/divisions make special overseas payments (other than regular expenditures) which are made through the Ministry of Foreign Affairs.

4.11.1.4 Payments made by missions abroad will be adjusted against the assignment account of the Ministry of Foreign Affairs, and expenditures recorded in ledgers maintained by the Ministry of Foreign Affairs. A monthly set of accounts will be forwarded by the Ministry of Foreign Affairs to the AGPR. Relevant expenditure relating to the various ministries would also be communicated to those ministries.

4.11.1.5 Unless otherwise specified the accounting policies set out in this chapter shall also apply to payments made overseas. Detailed procedures for processing overseas payments and maintaining accounts in relation to overseas payments are regulated by the Ministry of Foreign Affairs.

---

## 4.12 Grants-in-aid, Contributions etc.

### 4.12.1 Introduction

- 4.12.1.1 Grants-in-aid and contributions refer to monies given by the Government to various public bodies and institutions for which no exchange of goods and services is required. These bodies typically include educational institutions, charities, welfare bodies and health institutions. Unless specifically exempted by the Government all grants-in-aid and contributions are provided to fulfil a defined objective or purpose.
- 4.12.1.2 The delegations required for payment of grants-in-aid or contributions to public bodies and other institutions is regulated under the “Delegation of Financial Powers”, GFR and detailed rules as set out by ministries, departments and local administrations under the powers vested in them. The following guidelines shall apply in the approval of grants-in-aid.
- 4.12.1.3 The delegated authority shall only approve grants in relation to those payments to be made in the current financial year. In addition, grant monies shall not be drawn unless expenditure is about to be incurred or reimbursement is required for expenditures previously incurred by the recipient. Grants in aid may be provided on a recurring (e.g. payment in monthly instalments over a fixed time period) or non-recurring basis (e.g. one-off payment).
- 4.12.1.4 Before approval of a grant, the delegated authority must obtain an audited financial statement from the recipient body, to justify the requirement for the grant and to ensure any previous grants have been spent for the purpose intended. When approving the grant, the delegated authority must indicate that an audited financial statement was received and the criteria for providing the grant was met (or, for any reason, was exempted from providing an audited financial statement). The purpose of the grant, and any conditions attached to it, must clearly be indicated by the delegating authority in any grant agreements as well as to the Accountant General.
- 4.12.1.5 Once approved by the delegated authority, a claim for payment, accompanied by the relevant documentation (e.g. grant agreement, financial clearance) shall be submitted to the DAO/AG/AGPR office for certification, authorisation and payment.
- 4.12.1.6 Where conditions have been attached to the utilisation of grant money, the delegated authority who approved the grant is responsible for ensuring the conditions have been met. This may require, where necessary, the provision of regular reports by the grant recipient or

audited financial statements by an independent auditor to the delegated authority. Where grant monies are provided on a reimbursement basis, signed copies of the relevant bills and vouchers of the recipient should also be obtained. The timing and regularity of such reports and disclosures shall be set out in the grant agreement between the delegated authority and the grant recipient.

4.12.1.7 Where the grant is to be provided by a series of recurring payments a separate claim shall be approved and submitted by the delegated authority, for each payment, along with the necessary documentation to show the conditions of grant have been met. The delegated authority who approved the grant shall maintain a schedule of payments made for each grant made under his/her authority.

4.12.1.8 Unless specifically exempted by the Government, the conditions of all grant agreements shall provide for:

- the time limit in which the utilisation of the grant applies
- the surrender of grant monies not spent at the end of the financial year
- the financial and other disclosures required of the grant recipient
- the cancellation or postponement of further grant payments by the paying authority, should the conditions attached to the grant be breached (e.g. if the required reports are not furnished).

#### 4.12.2 Accounting Entries

4.12.2.1 The following double entry shall be made to record the transaction relating to grants-in-aid and contributions.

Dr		Grants and subsidies account
	Cr	Cheque clearing account

[to record the amount charged to the relevant detailed expenditure head under grants and subsidies. This entry shall be recorded in the General Ledger on the date the cheque is issued.]

Dr		Cheque clearing account
	Cr	Bank account

[to record the amount cleared from the bank account. This will be the date as per the Bank Return.]



**4.13 Assignment Account and Personal Ledger Account**

- 4.13.1.1 Refer to Chapter 17 “Assignment Accounts and Personal Ledger Accounts” for procedures on assignment account and personal ledger account.

---

## 4.14 Maintenance of Permanent Accounting Records

### 4.14.1 Introduction

4.14.1.1 Proper controls shall be followed in the maintenance of permanent accounting records associated with the payroll, GP fund and pension payment processes described in this chapter. These permanent accounting records shall be updated on an as required basis. The following key controls shall apply to permanent accounting records:

- all amendments must be approved by a delegated authority before they are processed
- checks must be in place to ensure all amendments to permanent accounting records entered into the system or manual registers are complete and accurate
- proper physical/system controls shall be in place to ensure only those authorised to make amendments have access to these records
- permanent accounting records shall be monitored on a regular basis to identify irregularities and report them to the concerned authority.

4.14.1.2 Permanent accounting records consist of the following registers. In the case of a computerised system, these records will be represented in a database:

- Establishment Register(form 4T)
- Payroll Register(form 4U)
- Pension Register(form 4V)
- GP fund Ledger(form 4W).

4.14.1.3 All permanent accounting records maintained on a manual basis will be entered in a date-wise order. As new records are required to be added, the next available page number will be used. Permanent records maintained on a computerised basis will be available in a variety of views, including alphabetically, employee ID-wise and date-wise. The key record (element) in all payroll, establishment and GP fund records shall be the employee identifier, which will be unique within all of Pakistan.

### 4.14.2 Establishment Register

4.14.2.1 This register is a control device which shall maintain all details of sanctioned posts within each unit of establishment. This includes records of both permanent and temporary posts, and filled and unfilled

---

posts. This register shall be used for budgeting and managing the strength of the particular unit of establishment (e.g. office, school, hospital). This register shall be maintained by each DAO/AG/AGPR.

4.14.2.2 The following permanent records shall be maintained for each unit of establishment:

- Establishment unit ID (DDO reference)
- Responsible ministry, division or department
- Number of posts (permanent and temporary) in total and by grade
- Number of posts filled
- History (e.g. posts filled last year)
- All position numbers with the unit of establishment, classified by grade and post type (permanent or temporary)
- Unit type (federal, provincial etc.).

#### **4.14.3 Payroll Register**

4.14.3.1 The register shall be maintained to record payroll records of each employee, for the purposes of payroll processing.

4.14.3.2 The Payroll Register shall be maintained by the Payroll Sections of each DAO/AG/AGPR office and must be updated prior to the preparation of the monthly pay bills.

4.14.3.3 The information contained in the Payroll Register shall contain:

- Employee ID (unique across all of Pakistan)
- Employee name
- Employee's fathers name (or employee's husband name)
- Address (temporary and permanent address)
- Contact phone number
- Marital status
- Date of birth
- Bank account details (for security reasons this may be controlled and accessed by a separate officer)
- Status (e.g. on leave, on deputation etc.)
- Current position number
- Current establishment id (DDO reference) \*
- Current grade \*
- Date of appointment to most current grade

- 
- Date of appointment into service
  - Current basis salary \*
  - Current allowances, classified by allowance type
  - Current deductions, classified by deduction type
  - Service history (e.g. previous positions and grades held, with dates of appointment)
  - Leave history.

4.14.3.4 It should be noted that in a computerised system those fields marked (\*) above, would be linked to other sources (such as the Establishment Register), and therefore would not require separate data entry.

4.14.3.5 Also in the Payroll Register, the following information should be maintained for each month and on a year-to-date basis for each employee:

- Base salary paid
- Each allowance paid, and in total
- Each deduction, including income tax, advances and GP fund deductions, and in total.

4.14.3.6 Once the financial year is complete, the monthly and annual payroll information shall be maintained for 10 years.

#### **4.14.4 Pension Register**

4.14.4.1 The Pension Register is a record of pension payments made as well as details of pensioners drawing payment.

4.14.4.2 The Pension Register is maintained by the Pension Sections of each DAO/AG/AGPR office and shall be updated whenever pensioners are added, amended or removed from the system.

4.14.4.3 The following information shall be maintained for each person receiving pension payment:

- Pensioners name
- Pensioners father's name (or husbands name)
- Identification number (i.e. National Identity Card number)
- Pensioner's address
- Contact phone number
- Date of birth

- 
- Date of retirement
  - Grade at retirement
  - Monthly pension amount
  - Mode of payment
  - Bank account details (for security reasons this may be controlled and accessed by a separate officer)
  - Pensioner type (federal, provincial)
  - Record of each pension payment made, date, amount and accumulated balance
  - Last date of pensioner status verification.

#### **4.14.5 GP Fund Ledger**

- 4.14.5.1 The GP Fund Ledger is used to maintain records relating to each employee's GP Fund contributions, advances drawn from the GP Fund and final payment from the GP Fund.
- 4.14.5.2 The GP Fund Ledger shall be maintained by the GP Fund Sections of each DAO/AG/AGPR office, and updated each month.
- 4.14.5.3 The following information shall be maintained for each employee within the GP Fund:
- Employee ID
  - Employee name \*
  - Current position number \*
  - Current grade \*
  - GP Fund type (e.g. Federal, provincial)
  - Date of entry into GP Fund
  - Monthly contribution to GP Fund from salary \*
  - Net accumulated GP Fund balance
  - Accumulated interest earned
  - Accumulated bonus earned
  - Advances drawn against GP Fund (individual amounts and dates drawn, and in total).
- 4.14.5.4 Upon an employee's retirement, the following information shall be added to the GP Fund Ledger before closure of the account:
- Date of retirement

- 
- Final payment amount, cheque (or direct credit) number and date of payment.

4.14.5.5 It should be noted that in a computerised system those fields marked (\*) above, would be linked to other sources (such as the Payroll Register), and therefore would not require separate data entry.

4.14.5.6 The GP Fund nomination form and records of any other significant events relating to an employees GP Fund shall be filed.

4.14.5.7 After retirement of the employee, GP Fund Ledger records shall be maintained for 10 years.

---

## Appendix to Chapter 4

### Commitment Accounting Alternative Treatment

This approach to recording commitments is an alternative to that provided in Section 4.4.3 of this Chapter. Whilst the end result is the same in terms of reporting, the accounting and other entries are different. It would only be practical to establish this alternative model in a computerised environment. It should be noted that the specific details of commitment accounting processes will be determined by the chosen accounting system.

#### 4.14.6 Commitment accounting records

4.14.6.1 **General Ledger** - Commitments will be maintained within the General Ledger, by a delegated officer in the DAO/AGPR/AG office. On receiving the commitment advice form from the DDO, this officer must record the commitment in the General Ledger.

4.14.6.2 When the claim voucher relating to a commitment previously entered into by the department/entity is received by the authorising officer, he/she must reverse the original commitment entry in the General Ledger upon authorising payment.

4.14.6.3 The fundamental difference with this approach to that shown in the text of the manual is that it records expenditures in the GL when commitments are entered into. This has two implications:

- adjusting entries are required in the GL for any variation that occurs after a commitment is established until it gets finally paid
- commitment accounts must be established in the GL for each budget head to be monitored

4.14.6.4 The balance of the commitment account represents those commitments still outstanding against the budget head.

#### 4.14.7 Recording of expenditure (General Ledger)

4.14.7.1 **Expenditure with commitment** - The following shall be recorded, where a commitment is established:

Dr		Expenditure head
	Cr	Commitment account

[to record the setting up of commitment]

Dr		Commitment account
	Cr	Cheque clearing account

[to record the actual expenditure and reversing of commitment, upon issue of payment]

Dr	Cheque clearing account
Cr	Bank account

[to record clearance of the payment]

4.14.7.2 **Expenditure without commitment** - the following entries shall be recorded, where a commitment has not been established:

Dr	Detailed expenditure head
Cr	Cheque clearing account

[to record the actual expenditure, upon issue of payment]

Dr	Cheque clearing account
Cr	Bank account

[to record clearance of the payment]

4.14.7.3 **Cancellation of issued payment (no commitment)**- where a issued payment has been stopped and cancelled, the following entry will be made:

Dr	Cheque clearing account
Cr	Detailed expenditure head account

[to record re-establishment of available funds where cheque has been issued and subsequently cancelled].

4.14.7.4 **Cancellation of issued payment (with commitment)** - If the cancelled payment related to a prior commitment, then the entry shall be:

Dr	Cheque clearing account
Cr	Commitment account

[to re-establish the commitment]



#### 4.14.8 Budget/funds control entries

4.14.8.1 The following entries shall be made to reflect the correct level of funds available in the Appropriation Control Register (manual system) or funds control module (computer system) whenever budgets are released, commitments established and payments made against a given budget head:

Budget head entries	Appropriation Control (cash available)	Funds Available
1) Establish funds	↑	↑
2) Enter commitment		↓
3) Make payment (with prior commitment)	↓	
4) Make payment (without prior commitment)	↓	↓

# 5 Receipts

---

## Table of Contents

<b>5.1</b>	<b>Introduction</b>	<b>5.3</b>
<b>5.2</b>	<b>General Policies</b>	<b>5.4</b>
5.2.1	General classification of receipts	5.4
5.2.2	Receipt of public money	5.4
5.2.3	Responsibilities	5.5
<b>5.3</b>	<b>Accounting Policies</b>	<b>5.7</b>
5.3.1	Currency	5.7
5.3.2	Recognition of revenue	5.7
5.3.3	Acceptable forms of receipt	5.7
5.3.4	Repayment and refund of expenditure	5.8
5.3.5	Receipts arising from recovery of inter-departmental services	5.9
5.3.6	Granting of discounts	5.9
<b>5.4</b>	<b>Accounting for receipts</b>	<b>5.10</b>
5.4.1	Manual accounting records	5.10
5.4.2	Computerised accounting records	5.10
5.4.3	Accounting entries for receipts	5.11
<b>5.5</b>	<b>Detailed Procedures</b>	<b>5.12</b>
5.5.1	Introduction	5.12
5.5.2	Flow diagram overview - receipt of public money through the Bank	5.13
5.5.3	Receipt of money by banks	5.14
5.5.4	Receipt of money by Post Offices	5.15
5.5.5	Receipt of money by other Government entities	5.16
5.5.6	Flow diagram overview - recording, consolidation and reconciliation of receipts	5.17
5.5.7	Recording of receipts in accounting offices	5.18
5.5.8	Consolidation of Receipts	5.19
5.5.9	Reconciliation of receipts	5.19
5.5.10	Receipt adjustments	5.19
<b>5.6</b>	<b>Treatment of specific classes of receipt</b>	<b>5.21</b>
5.6.2	Consolidated Fund	5.21
5.6.3	Public Account	5.23

## 5.1 Introduction

- 5.1.1.1 This chapter deals with policies, accounting treatment and procedures in relation to receipts.
- 5.1.1.2 The policies include both general policies for receipts and accounting policies.
- 5.1.1.3 The accounting treatment details the records which need to be maintained for complete and accurate recording of receipts and the appropriate double entries for recording the transactions in the General Ledger.
- 5.1.1.4 The procedures cover the collection, recording, consolidation of receipts generally. Additionally there are further procedures for specific classes of receipt. The objective of the procedures is to ensure the proper application control of receipts, and the provision of reliable and complete revenue information for Government monitoring purposes.

---

## **5.2 General Policies**

### **5.2.1 General classification of receipts**

- 5.2.1.1 Receipts collected by the Government belong to either the Consolidated Fund or the Public Account of the respective Federal and Provincial Governments of Pakistan.
- 5.2.1.2 All monies collected and accounted for as revenue of the Government shall form part of the Consolidated Fund and therefore are available for annual appropriation. Both capital receipts (receipts sourced from financing activities) and revenue receipts (receipts sourced from government operations) belong to the Consolidated Fund. Also refer to Article 24 of the Account Code, Volume 1 and Article 78 (1) of the Constitution.
- 5.2.1.3 Public Account receipts are monies collected by the Government on behalf of other parties or held in trust for a special purpose and are therefore not available for annual appropriation.

### **5.2.2 Receipt of public money**

- 5.2.2.1 All monies received as revenue of the Government, must be banked in the name of the Government without delay and included in the Consolidated Fund of the respective Federal or Provincial Government.
- 5.2.2.2 Public Account receipts, other than revenue, must be banked in the name of the Government without delay and included in the Public Account of the respective Federal or Provincial Government.
- 5.2.2.3 All receipts should be identified in accordance with the Chart of Accounts specification.
- 5.2.2.4 Amounts due to the Government should only be tendered at branches of the State Bank of Pakistan or at branches of the National Bank of Pakistan, acting as an agent for the State Bank of Pakistan, unless otherwise authorised by the Government.
- 5.2.2.5 Officers receiving public money will be held accountable for all public monies received by them and must maintain a proper record of receipts.
- 5.2.2.6 All amounts to be deposited into the Government's bank account must be accompanied by a receipt voucher.

- 
- 5.2.2.7 Any person making a payment to the Government is entitled to receive proof of payment, through the issue of an official receipt drawn and signed by the receiving officer.
- 5.2.2.8 Collection of public monies must not be mixed with collection of private monies. For example, no private monies should be kept in official safes or bank accounts.
- 5.2.2.9 Public monies may be collected at a post office for specified classes of receipt, as determined by the Government.
- 5.2.2.10 Public monies received in cash, cheque or any other form of payment will not be accepted by Government entities at their own offices, unless specifically authorised by the Government. In cases where receipting at Government offices is permitted, the Principal Accounting Officer of the concerned entity must ensure proper control and that record of receipts is maintained and public monies are promptly deposited into the Government's bank account.
- 5.2.2.11 Any public monies received by a Government office, where permitted under the above direction are not revenues on the part of the collecting entity. No public monies received by a Government office will be retained to meet departmental or other forms of expenditure unless otherwise permitted by the Government.

### **5.2.3 Responsibilities**

- 5.2.3.1 The Principal Accounting Officers of those entities responsible for administering revenue collections (such as tax authorities) must ensure that all sums due to the Government are promptly realised, banked and credited to the Consolidated Fund. The Principal Accounting Officers of these entities must also ensure that:
- public monies credited to the Consolidated Fund as reported by the Accountant General, are reconciled/verified with their own records, at least on a monthly basis
  - procedures for the generation, control and assessment of bills and demand notices as required under departmental regulations are followed.
- 5.2.3.2 The overall responsibility for the accounting of receipts rests with the Auditor-General, under the following administrative arrangements:
- Provincial and Federal Government receipts will be recorded by the respective Accountants General in each of the Provinces through the District Account Offices and Treasury Offices.
  - Federal Government receipts will also be recorded by the Federal Treasury Office, and where authorised by the Government with the

consent of the Auditor-General, at special purpose treasuries (e.g. Customs treasury).

- Provincial Government receipts will be consolidated by the Accountant General's office in the respective Provincial capitals
- Federal Government receipts will be consolidated initially by the AGPR sub-offices located in each Provincial capital, and finally at the AGPR.

5.2.3.3 The following diagram is a representation of the overall flow of information from the bank to the Government:

### Flow of receipt information from bank to DAO/AG/AGPR

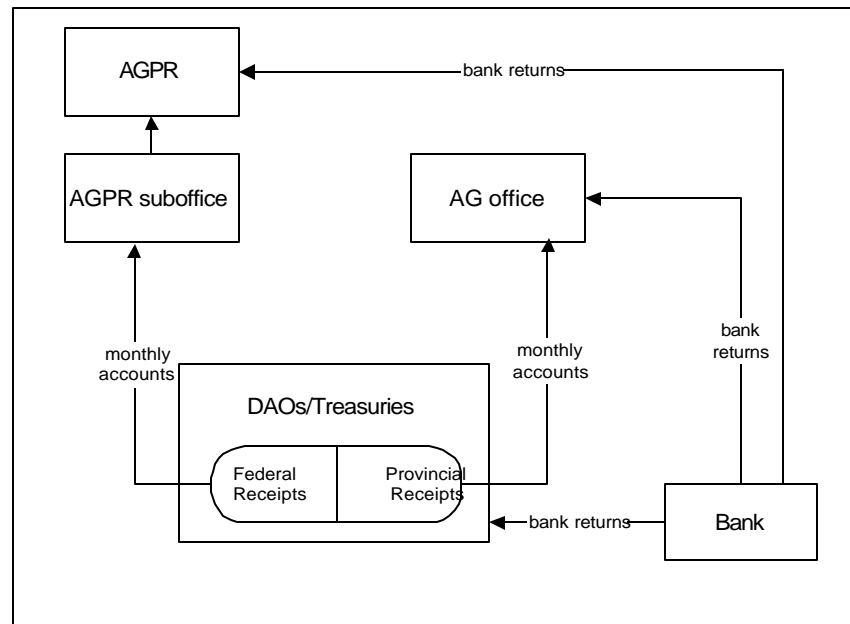

---

### **5.3 Accounting Policies**

#### **5.3.1 Currency**

5.3.1.1 All receipts must be accounted for in Pakistani Rupees.

#### **5.3.2 Recognition of revenue**

5.3.2.1 Recognition of revenue occurs after the receipt of the money by the bank or clearance of the cheque. This will be reflected in the accounting records when the bank scroll is received by the AG, AGPR, DAO or Treasury Office.

5.3.2.2 In the case of receipts arising from borrowings, revenue must be recognised and recorded in the accounts on the date that the funds are received at the bank.

5.3.2.3 Where receipts are collected at a department/entity, the revenue will be recognised in the accounts of the Government after the money is deposited at the bank by the concerned entity.

5.3.2.4 Receipts shall be recorded on a gross basis, that is, at the full amount received from the payer. Receipts will not be recorded net of any related costs, such as commissions or fees. Such costs are to be recorded separately as expenditures, under the relevant expenditure head. Refer to example shown in Direction 5.4.3.3

#### **5.3.3 Acceptable forms of receipt**

5.3.3.1 Sums due to the Government may be paid in cash, cheque, bank draft, postal order and other forms as authorised by the Government. If payment is received by cheque then the following conditions must be met:

- the cheque must be marked and crossed as 'not negotiable' and made payable to the Federal Government or Provincial Government as the case may be. If this has not been done then it should be completed by the bank teller
- the cheque must have printed on it the amount in words as well as figures
- under no circumstances should change be given to the payer.

5.3.3.2 Amounts received by cheque will only be recognised and recorded in the accounts when the cheque is cleared by the bank. The receipt voucher will not be stamped by the bank and issued to the payer until the cheque has been cleared.



- 
- 5.3.3.3 If a cheque is dishonoured by the drawer's bank, the payer's indebtedness to the Government is retained and appropriate recovery action will be taken, including notification by the bank to the concerned administrative department.
  - 5.3.3.4 Persons required to pay the Government by a fixed date must take steps to ensure that their payment reaches the bank by the due date for payment. In the case of cheque payment, at least 2 days margin needs to be given in order to clear the cheque.
  - 5.3.3.5 Post-dated cheques should not be accepted. Whilst a post dated cheque is a valid instrument, it will not be honoured by the bank it is drawn on until the date on the cheque is reached. Therefore when a person tenders a post-dated cheque, no payment is considered to be made, and no receipt can be issued, until the date of the cheque is reached.
  - 5.3.3.6 Payment by credit card or direct deposit facilities will not be accepted unless approved by the Government.

#### **5.3.4 Repayment and refund of expenditure**

- 5.3.4.1 Public monies collected as a result of an overpayment previously made by the Government in the same financial year must be adjusted to reflect the correct level of expenditure that was originally incurred. Such receipts must not be treated as revenue.
- 5.3.4.2 A refund received by the Government for goods and services purchased represents a reduction in the original expenditure incurred by the Government. Refunds received must not be considered as revenue.
- 5.3.4.3 It is permissible in cases where the original expenditure head used is not immediately known, for the repayment/refund to be charged to an appropriate suspense account. This account must be reviewed and cleared on a monthly basis.
- 5.3.4.4 Repayments of expenditure from annual appropriation, occurring in a subsequent financial year to the original transaction must be credited to revenue.
- 5.3.4.5 Repayments of expenditure from Public Account heads must be credited to the same head regardless of when the original expenditure was incurred.

---

**5.3.5 Receipts arising from recovery of inter-departmental services**

5.3.5.1 Recoveries arise when goods and services are purchased in one department and are passed on to another department within the same Government.

5.3.5.2 Recoveries made by charging departments for inter-departmental goods and services are not to be recognised as receipts, as they are internal to the Government concerned, and will not to be processed through the banking system. These recoveries are to be recorded as a contra-entry to the original expenditure incurred by the charging department. Refer to Chapter 12, 'Transactions between Government entities'.

**5.3.6 Granting of discounts**

5.3.6.1 Discounts for negotiation of early payment will not be provided to payers, unless authorised by the Government. Where a discount has been given the amount of discount must be indicated on the receipt voucher.

---

## 5.4 Accounting for receipts

### 5.4.1 Manual accounting records

5.4.1.1 The following primary books of account must be maintained by the accounts section of the District Account office and the Accountant General office. All such records must be maintained in Pakistani Rupee.

5.4.1.2 **Sub-ledger** - once the bank return is received, the receipt transaction must be recorded in the Sub-ledger in date order. The delegated officer must enter the following details of receipt in the Sub-Ledger:

- date of receipt (not the date the scroll was received)
- receipt reference (e.g. receipt number)
- receipt description
- account code (detailed receipt head)
- department reference (if applicable)
- amount in Rupees.

The delegated officer must total this Sub-ledger up at the end of each day and post the daily totals, by account code, to the General Ledger.

5.4.1.3 **General Ledger** - the General Ledger will record balances of receipts and expenditures on a daily total basis. The daily totals of receipt, by account code) must be entered into this ledger. Details should include:

- date
- account as per Chart of Accounts
- account description
- amount in Rupees.

5.4.1.4 **Abstract** - In a manual accounting system, it is necessary to prepare an abstract as a supplement to these ledgers, in order to obtain details from the Sub-ledger or General Ledger in an alternative order, or to consolidate information for reporting purposes.

### 5.4.2 Computerised accounting records

5.4.2.1 The computerised system will automatically post the entries from the Sub-ledger to the General Ledger, by account code, and be capable of producing the necessary views and consolidation points for reporting purposes.

5.4.2.2 In the computerised system the delegated officer in the accounts section of the District Accounts Office or the Accountant General Office will enter receipt details into the Sub-ledger equivalent of the computerised system.

### 5.4.3 Accounting entries for receipts

5.4.3.1 The double entry required for the recognition of revenue generally is:

Dr		Bank account	
	Cr		Revenue account (detailed head)

[to record receipts or advances collected, and placed into the Consolidated Fund]

5.4.3.2 The double entry required for recovery of overpayment or refund of payment, within the current financial year is:

Dr		Bank account	
	Cr		Relevant expenditure head

5.4.3.3 The double entry required for receipt consisting of cash amount and an associated expense (such as a commission). For example, cash of Rs 900 received, commission paid of Rs 100:

Dr		Bank account	Rs 1000
	Cr	Revenue	Rs 1000

and

Dr		Commission expense	Rs 100
	Cr	Bank account	Rs 100

5.4.3.4 Where a discount has been given by the Government, the discount shall be recognised as an expense. For example, cash received Rs 500, discount given Rs 50:

Dr		Bank Account	Rs 550
	Cr	Revenue	Rs 550

and

Dr		Discounts given	Rs 50
	Cr	Bank Account	Rs 50

## **5.5 Detailed Procedures**

### **5.5.1 Introduction**

5.5.1.1 The processing of receipts must comply with the directions laid out in previous sections of this chapter and observe the following internal controls:

- all monies received for the Government must be receipted
- the officers receiving money must be different to officers raising demands and bills for payment
- the officers receiving money and recording the receipt in the accounting records must be different
- accounting records of receipts must be reconciled to the tax authority receipt records on a regular basis by a delegated authority, independently of the officer recording the transaction
- a regular bank reconciliation must be performed (Chapter 6)
- monthly financial reports must be produced and monitored by a delegated authority (Chapter 7).

**5.5.2 Flow diagram overview - receipt of public money through the Bank**

5.5.2.1 The following flow diagram is a representation of the receipting process, for public monies received by the State Bank of Pakistan or National Bank of Pakistan.

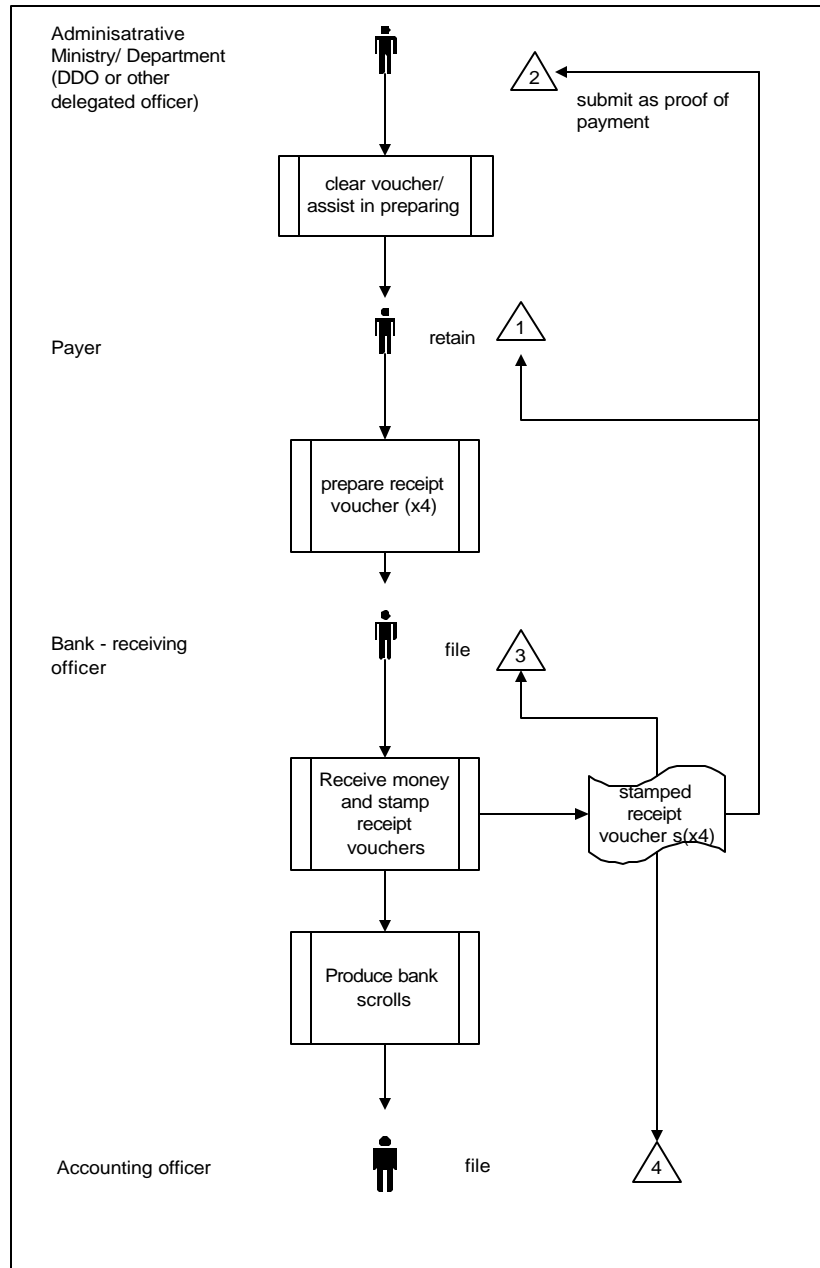

---

### 5.5.3 Receipt of money by banks

5.5.3.1 The directions laid down in Section 5.2.2, 'Receipt of Public Money' applies to the receipt of public money by the branches of the State Bank and National Bank of Pakistan.

5.5.3.2 The receiving officer at the bank must ensure that the person submitting payment to the Government has prepared a receipt voucher (form 5A) , specifying:

- their name
- the nature of receipt
- amount tendered
- place of deposit.

5.5.3.3 Four copies of the receipt voucher must be completely and accurately prepared. The payer may seek assistance from the concerned administrative department in obtaining and preparing the receipt vouchers, where necessary.

5.5.3.4 The receipt voucher must be presented, with the money, to a branch of the State Bank or National Bank of Pakistan. Upon receipt of money, all copies of the receipt voucher must be date -stamped and signed by the receiving officer at the bank.

5.5.3.5 The stamped receipt vouchers must be distributed as follows:

- the original copy is retained by the payer
- the second copy is presented to the administrative department as proof of payment (where required)
- the third and fourth copies are retained by the bank.

5.5.3.6 The person making payment is entitled to receive an official receipt from the bank (Direction 5.2.2.7). This requirement is met by the stamping and signing of the receipt voucher (Direction 5.5.3.4). Furthermore:

- no additional copies of receipt voucher will be provided in the event of loss of the original. If requested by the payer, a letter may be provided giving particulars of the receipt voucher that was issued
- a unique, sequential receipt reference number must also be stamped on all copies of the receipt voucher by the receiving officer. The receiving officer must keep a record of this number series and account for any gaps to their supervising officer.

- 
- 5.5.3.7 When payment is received in the form of cheque, the policy specified in Directions 5.3.3.1 to 5.3.3.5 should be followed. These directions apply equally to other forms of legal tender, such as bank draft and postal order.
- 5.5.3.8 The government bank account to be used will be determined by the nature of the receipt. The relevant government bank account should be clearly marked on the receipt voucher. The Government to which the receipt is attributable must be also clearly identified on the receipt voucher.
- 5.5.3.9 At the end of each day, the bank will balance the amounts received to the receipt vouchers. These transactions are then to be incorporated into the daily bank scrolls (form 6A) prepared for each government bank account maintained at that branch. These scrolls will then be passed to the relevant District Accounts Office or Treasury Office as the case may be, along with the fourth copy of the receipt voucher.

#### **5.5.4 Receipt of money by Post Offices**

- 5.5.4.1 Public monies received at the Post Office, acting as an agent of the Government, include collections of motor vehicle tax and various licence fees. The Post Office also conducts savings bank activities.
- 5.5.4.2 Public monies received by the Post Office must only be conducted at the 'Postal Bank' facility of the Post Office. Where public monies are received by Post Offices, the general policies set out Section 5.2.2 must apply.
- 5.5.4.3 Amounts tendered to the Post Office, where it is acting as an agent of the Government, must be accompanied by a complete and accurate receipt voucher. Upon receipt of the money, the Postal Bank officer shall date-stamp and sign all copies of the receipt voucher and return a copy to the payer. This officer must also stamp any other relevant documents (e.g. licence or passbook).
- 5.5.4.4 The procedures laid down in Directions 5.5.3.6 to 5.5.3.8 also apply to the Post Office performing receipting functions.
- 5.5.4.5 The delegated authority within the Post Office must compile the total daily collections for each type of receipt and authorise deposit into the Government's bank account.
- 5.5.4.6 A monthly account will be compiled by the Post Office, including all receipts it has collected on behalf of the Government and pass onto the relevant accounting office. Where applicable, the Post Office shall



---

also furnish monthly reports to the relevant administrative ministries and departments, with signed copies of receipt vouchers.

5.5.4.7 The commission due to the Post Office for performing an agency for the Government is recovered through the monthly exchange process. (refer Chapter 12, 'Transactions between Government Entities'). The rates of commission will be determined by agreement between the Post Office and the Government.

### **5.5.5 Receipt of money by other Government entities**

5.5.5.1 Where Government entities are permitted to receive public money in their own offices, the general policies set out in Section 5.2.2 also apply.

5.5.5.2 The collection office of an entity authorised to receive public monies must be a secure area.

5.5.5.3 Amounts tendered to a Government entity must be supported by a receipt voucher as set out in Directions 5.5.3.2. Upon receipt of money, all copies of the receipt voucher are to be date-stamped and signed by the receiving officer of the entity.

5.5.5.4 The stamped receipt vouchers must be distributed as follows:

- the original copy is retained by the payer
- the second copy is kept by the entity as proof of payment
- the third and fourth copies are to be passed on to the bank, when the daily collections are banked by the receiving officer.

5.5.5.5 The procedures laid down in Directions 5.5.3.6 to 5.5.3.8 also apply to Government entities performing receiving functions.

5.5.5.6 An officer, independent of the receiving officer must maintain a cashbook containing a date-wise record of all receipts collected. This officer must verify that the deposit slip from the bank, agrees with the receiving officer's receipt vouchers for that day.

5.5.5.7 Amounts exceeding Rs 1,000 should be banked on the same day received by the entity. If such an amount is received by the entity after the bank has closed for the day, it must be held in the entity's safe and banked immediately the following day.

5.5.5.8 Receiving officers handling Government money should not also handle non-Government money in their official capacity.

**5.5.6 Flow diagram overview - recording, consolidation and reconciliation of receipts**

5.5.6.1 The following flow diagram is a representation of the receipt recording, consolidation and reconciliation process.

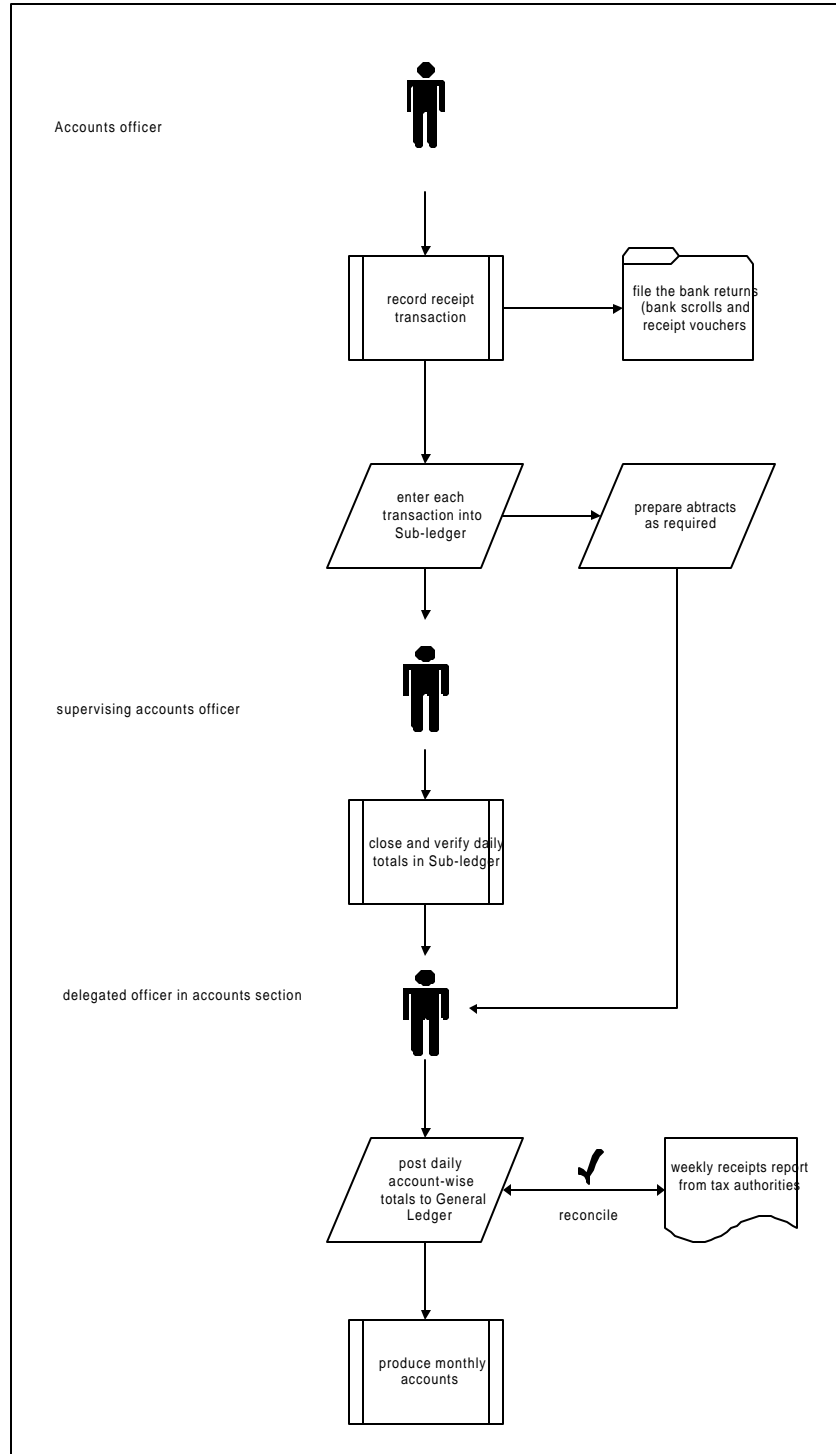

---

### 5.5.7 Recording of receipts in accounting offices

- 5.5.7.1 It is the responsibility of the Accountant General to ensure that all government receipts are transmitted to the SBP as soon as possible. He/she must ensure that the arrangements for distribution of daily bank returns (scrolls and supporting receipt vouchers) to the respective accounting offices are in place, and that all bank branches receiving public money are regularly submitting returns. The following procedures are applicable to each accounting office receiving bank returns for receipts.
- 5.5.7.2 An accounting office is defined here as the accounts sections of any of the following organisations:
- AGPR/AG
  - District Treasury
  - District Accounts Office.
- 5.5.7.3 Once bank scrolls are received in an accounting office, the scroll number, date received, total amount and transaction count must be recorded in a control sheet. Each scroll entry should be checked to ensure they match to an attached receipt voucher.
- 5.5.7.4 It is the responsibility of the accounting officer to ensure the classifications made in respect of each receipt are correct. If not already done, the appropriate receipt head must be written on the receipt voucher by the accounting officer. If in doubt, the concerned administrative department should be contacted for clarification on the proper receipt head to be used.
- 5.5.7.5 From the scroll and the supporting receipt vouchers, the accounting officer must then record each of these transactions in the Sub-ledger. This must include the amount, particulars, receipt head and receipt number of each transaction, in date order.
- 5.5.7.6 If necessary for compilation and reporting purposes, other receipt registers may be maintained. For example a register may be maintained to record DDO-wise and head-wise receipts. All such subsidiary registers must reconcile on a monthly basis to the Sub-ledger.
- 5.5.7.7 The daily total of receipts recorded in the Sub-ledger must reconcile to the control totals of all bank scrolls received for that day. At the end of each day, the Sub-ledger must be closed, verified and signed off by a delegated authority.

5.5.7.8 After the receipts have been recorded in the Sub-ledger and the General Ledger, the receipt vouchers and bank scrolls shall be filed in the accounting office.

### 5.5.8 Consolidation of Receipts

5.5.8.1 The daily totals for each receipt head from the Sub-ledger must be posted to the General Ledger at the end of each day. Under a manual system this may require an account-wise abstraction from the Sub-ledger.

### 5.5.9 Reconciliation of receipts

5.5.9.1 The monthly reconciliation of the General Ledger will be performed as set out in Chapter 6 'Bank Reconciliation'. Receipts recorded by the bank/accounting office must be reconciled on a monthly basis to the collections recorded by tax and other revenue administration authorities.

5.5.9.2 Where entities maintain their own cashbooks, a reconciliation must be performed at the end of each month with the relevant amounts recorded in the Sub-Ledger. For this exercise, it will be necessary for the accounting office to abstract the relevant entity-wise amounts from the Sub-ledger.

5.5.9.3 The Accountant General and the tax collecting agencies will be jointly responsible for reconciliation of tax revenues, in the manner prescribed by the Auditor-General.

### 5.5.10 Receipt adjustments

5.5.10.1 If a cheque is received which is subsequently dishonoured by the bank, it will not appear in the bank scroll (Direction 5.3.3.2) and therefore does not require an adjustment by the accounting office. However, the administrative entity must be advised to ensure appropriate follow up action to be taken with the payer.

5.5.10.2 If an error is identified in the classification or amount of receipt then an adjusting entry is required. The original entry in the Sub-ledger must be reversed as a separate entry in the Sub-ledger and cross referenced to the original entry. The correcting entry is then made, as a separate line in the Sub-ledger. The correction must be initialled by a delegated authority in the accounting office. For example if an amount of Rs 500 to receipt head 1, should have been made as Rs 750 to receipt head 2, then the required entries are:

Dr	Receipt head 1	500
	Cr	
	Bank account	500

---

and

Dr		Bank Account	750
	Cr	Receipt head 2	750

---

## 5.6 Treatment of specific classes of receipt

5.6.1.1 This section outlines some of the specific classes of receipt in relation to their accounting treatment and any specific accounting procedures. It is not intended to be an exhaustive list of all receipts, as this may be obtained from the Chart of Accounts.

### 5.6.2 Consolidated Fund

#### 5.6.2.1 Revenue receipts - direct taxes

- *income tax* - includes personal and company income taxes. The procedures for income tax assessment and collection, are regulated under the Income Tax Ordinance, 1979. Income tax receipts, shall be deposited at the State or National Bank of Pakistan, as set out in Section 5.5.2. Tax instalments deducted from employees' salaries shall be paid by the employer into the State or National Bank, with receipt voucher, in accordance with the Income Tax Ordinance.
- *property and wealth tax* - includes taxes on wealth, capital value tax and tax on immovable property and land. The procedures for property and wealth taxes are regulated under the Wealth Tax Act, 1963. Similarly these amounts shall be deposited, with receipt voucher at the State or National Bank of Pakistan.

#### 5.6.2.2 Revenue receipts - indirect taxes

- *customs duty and excise* - includes customs duty imposed on imports and exports and customs related fines, fees and penalties. These receipts are normally recorded by Customs Treasuries. Excises include Federal and Provincial excise duties on a range of products, commodities and services. The procedures relating to customs duty and excises are regulated by the Customs Act, 1969. In all cases the amount of duty or excise shall be deposited, with a receipt voucher, at the State or National Bank (or Post Office, as the case may be).
- *sales tax* - applies to goods imported, exported or produced in Pakistan. Specific procedures, levies and exemptions in relation to sales tax is regulated by the Sales Tax Act, 1990.
- *withholding tax* - withholding tax on interest earned in bank accounts shall be deducted by bank, transferred to the Government bank account and included in the daily bank scroll. Where withholding tax payable by contractors is deducted at source, this amount shall be deposited by the employer into the State or National Bank in accordance the regulations set out in the Income Tax Ordinance, 1979.

---

#### 5.6.2.3 Revenue receipts - other income

- *income from trading enterprises* - the Government may obtain income from trading enterprises that it owns, other than dividends. These include proceeds of excess wheat and other commodities, recoveries, subsidies (where realised in cash) and receipts from the sale/privatisation of trading enterprises.
- *interest received* - interest received is to be treated as Consolidated Fund revenue, at the time loans and advances are repaid, or upon encashment of Government investments.
- *dividends received* - where the Government receives a dividend from any trading enterprises in which it is a shareholder, this will be recognised as Consolidated Fund revenue when the interim or final dividend is received.
- *proceeds from sale of stores and assets* - proceeds from the sale of stores and surplus assets are to be treated as Consolidated Fund revenue, where the initial purchase was made from the Consolidated Fund. If initial purchase was made from the Public Account the amount should be credited back to the relevant Public Account head. Sale proceeds should not be shown net of selling costs.
- *grants and contributions received* - any grants or contributions received by the Government, which results in an inflow of cash or cash equivalent, is to be treated as Consolidated Fund revenue. However, if the Federal Government receives grant monies on behalf of a Provincial Government or other bodies, these monies shall not be treated as revenue in the hands of the Federal Government. (and vice versa).
- *judicial receipts* - refers to any fees, fines or penalties levied by the civil and criminal courts, arising from the judicial process. These receipts shall be distinguished from judicial deposits (which are placed into Public Account) and judicial stamp duties which are classified under indirect taxes.

#### 5.6.2.4 Capital receipts

- *recoveries of investment* - refers to recoveries (either from charging or from sale proceeds) made from various capital works, including drainage and irrigation works. It also includes recoveries from investments in financial institutions.
- *recoveries of loans and advances* - where the Government provides loans to Provinces, local bodies or other institutions, the recovery of principal is recorded as a capital receipt. Where Government servants take out an advance, such as a house or motor vehicle advance, the recovery is also a capital receipt and

---

will be recognised when repayments are made by salary deduction.

- *public debt* - receipts arising from all forms of public debt, including internal and external borrowings, are placed into the Consolidated Fund under this head. The receipt is recognised when advised by those entities managing public debt.

### 5.6.3 Public Account

#### 5.6.3.1 Savings schemes

- *savings bank deposits* - these are deposits made into various savings accounts operated by the Government such as Savings Bank accounts, National deposit accounts and Khaas Deposit Accounts. These accounts are normally maintained with Post Offices and National Savings Centres.
- *federal savings and deposit certificates* - these are deposits made for savings and deposit certificates (bonds) issued and guaranteed by the Government. Includes Defence Savings Certificates, Premium Savings Certificates and National Deposit Certificates.

#### 5.6.3.2 Departmental and judicial deposits

- *revenue deposits* - these are deposits made in Revenue Courts or in relation to revenue administration, such as customs deposits, guarantees, earnest deposits and security deposits.
- *civil and criminal court deposits* - these are deposits received by the courts, including the High Court and Small Cause Courts, pending settlement. which will be either refunded to the payer or transferred to the Consolidated Fund, depending on the outcome. These amounts, when received are to be deposited at the bank.
- *personal deposits* - personal deposits are funds dedicated to a particular purpose, for which a separate account is kept by the Treasury Office. Contributions into these funds are made by payment from the Consolidated Fund or payments by other bodies. These include famine relief, flood relief, emergency relief etc.
- *deposits of self-accounting entities* - each self-accounting entity normally maintains separate accounts for deposits received under their own rules and regulations.
- *deposits of local fund* - these are deposits made to local bodies under the general control of Government or with regard to specific matters only. Monies shall not be placed into these funds without approval by a delegated authority in the Government. The balances



---

of each local fund are to be verified by the Accountant General at the end of each financial year.

# 6 Bank Reconciliation

---

## Table of Contents

<b>6.1 Introduction</b>	<b>6.3</b>
<b>6.2 Overview</b>	<b>6.4</b>
<b>6.3 General Policies</b>	<b>6.5</b>
6.3.1 Relationship with bank	6.5
6.3.2 Daily returns by Main Designated Branch	6.5
6.3.3 Cash balance and cash reporting	6.6
6.3.4 Monthly reconciliation	6.7
6.3.5 Monthly reconciliation statement	6.7
<b>6.4 Daily Procedures</b>	<b>6.9</b>
6.4.1 Daily procedures flowchart	6.9
6.4.2 Daily procedures by bank	6.10
6.4.3 Daily procedures by DAO/AG/AGPR	6.11
<b>6.5 Monthly Procedures</b>	<b>6.12</b>
6.5.1 Monthly procedures flowchart	6.12
6.5.2 Monthly procedures by bank	6.13
6.5.3 Monthly procedures by DAO/AG/AGPR	6.14
6.5.4 Summary of bank reconciliation by Accountant General	6.15

## 6.1 Introduction

- 6.1.1.1 This chapter covers the accounting policies and procedures applicable to the bank reconciliation.
- 6.1.1.2 This chapter lays down processes to be followed by both the Bank and the Accountant General in order to perform daily and monthly reconciliation functions.
- 6.1.1.3 The State Bank of Pakistan and the National Bank of Pakistan, acting as an agent for the State Bank of Pakistan, shall be the Government's banker, unless otherwise authorised by the Government.
- 6.1.1.4 This chapter does not address the procedures and internal controls operative within the State or National Bank.
- 6.1.1.5 For the purpose of this chapter branches of the National Bank are describe as follow:
- **Category A branch** - these are main branches of the NBP and are normally situated in urban areas
  - **Category B & C branch** - these branches are normally situated in rural and remote areas.
- 6.1.1.6 The following key internal controls must be observed in the bank reconciliation processes:
- there shall be a one-to-one relationship between the DAO/AG/AGPR and a designated branch of either SBP or NBP referred to as the Main Designated Branch
  - all receipt vouchers shall be sequentially numbered by the bank
  - the DAO/AG/AGPR shall check the bank scroll with the payment advice note on a daily basis
  - the DAO shall prepare a monthly reconciliation statement for receipts and expenditures
  - the Accountant General shall prepare a consolidated monthly reconciliation statement for each government bank account.

6.2 Overview

The following is a summary of the relationship between the DAO/AG/AGPR, the bank and the payee/payer.

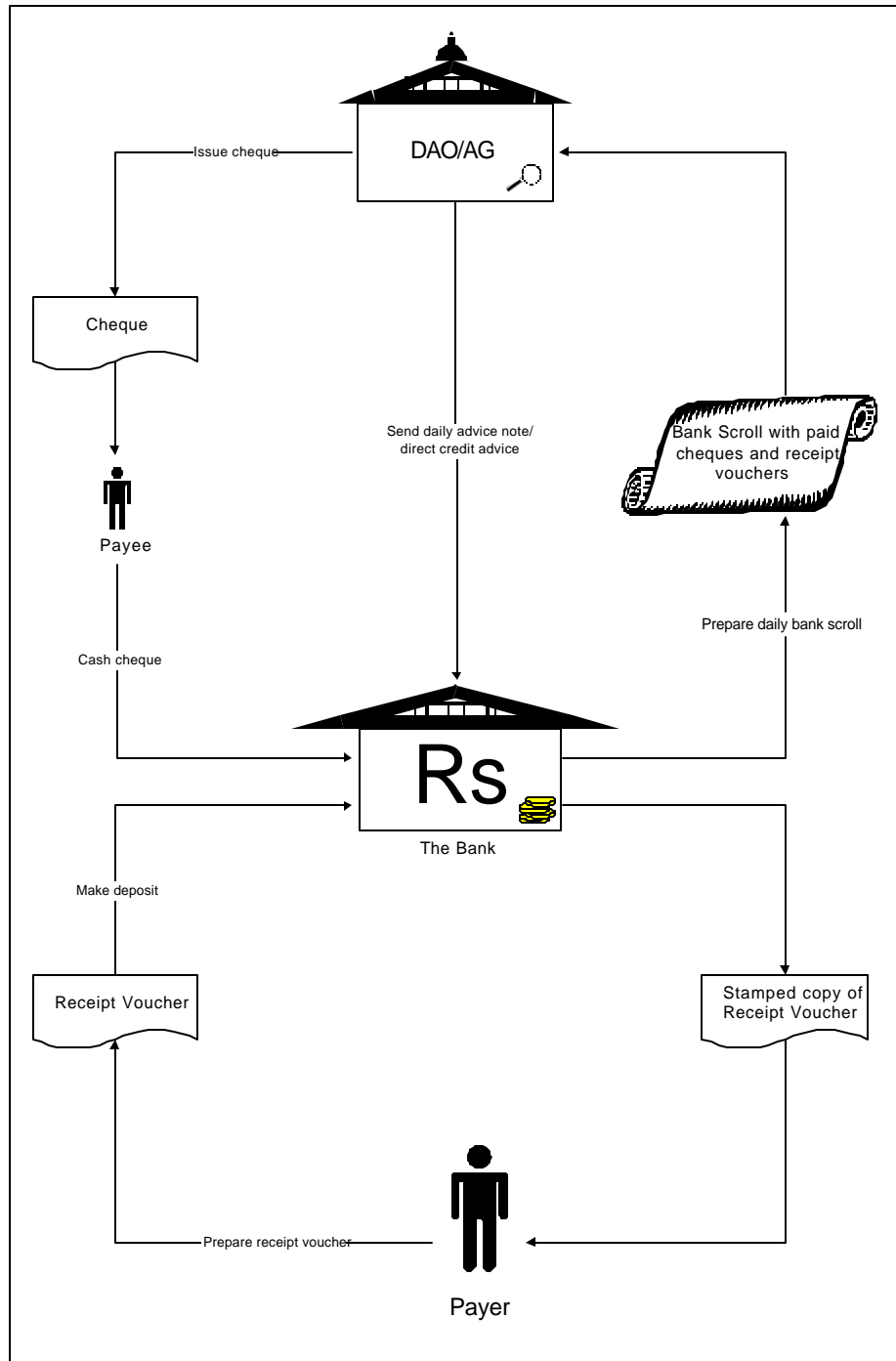

---

## **6.3 General Policies**

### **6.3.1 Relationship with bank**

- 6.3.1.1 For payment purposes, the DAO (and AG/AGPR making payments) shall only deal with one designated branch of either SBP or NBP in their jurisdiction and this shall be deemed as the Main Designated Branch.
- 6.3.1.2 Where a SBP branch exists, the DAO/AG/AGPR shall deal with that SBP branch. Where a SBP branch is not in the jurisdiction, the DAO/AG/AGPR shall deal with the designated category A branch of the NBP. Where neither an SBP branch nor a category A branch of the NBP exists, the DAO/AG/AGPR shall deal with the designated category B branch of the NBP.
- 6.3.1.3 Cheques issued by the DAO/AG/AGPR can be presented at any bank branch by payee and shall only be cleared at the Main Designated Branch through the bank clearing system.
- 6.3.1.4 The Main Designated Branch shall only clear cheques which are listed on an advice note sent by the concerned DAO/AG/AGPR.
- 6.3.1.5 For receipt purposes, government revenue can be deposited at any branch of SBP or NBP authorised to collect government revenue.
- 6.3.1.6 The adjustments to government bank accounts shall be performed by the SBP as authorised by the AG/AGPR.

### **6.3.2 Daily returns by Main Designated Branch**

- 6.3.2.1 The Main Designated Branch shall submit a daily return to the concerned DAO/AG/AGPR in the form prescribed by the Auditor-General. The daily return shall include the following:
- bank scroll (form 6A)
  - paid cheques
  - receipt vouchers
  - transfer advices.
- 6.3.2.2 When a receipt voucher is deposited at a bank branch, that branch shall allocate a sequential number to it. Where the bank branch receiving the receipt voucher is not the Main Designated Branch reporting to the DAO/AG/AGPR, that branch shall forward all receipt vouchers to the designated main branch at the end of the day. The Main Designated Branch shall then allocate its own unique sequential

---

number when reporting, along with the bank scroll, to the DAO/AG/AGPR.

6.3.2.3 The Main Designated Branch shall submit a separate daily return for each government bank account and for:

- expenditure - federal government
- expenditure - provincial government
- receipts - federal government
- receipts - provincial government
- adjustments between government departments
- adjustments between different governments.

6.3.2.4 The two main government bank accounts (separate for each government) are:

- Non-food Account (I) relating to other than food transactions
- Food Account (II) relating to food transactions.

6.3.2.5 The Main Designated Branch shall report on a monthly basis to the relevant DAO/AG/AGPR through the Monthly Main Designated Branch Statement (MMDBS).

### **6.3.3 Cash balance and cash reporting**

6.3.3.1 The head office of SBP shall report cash balances of each government bank account on a daily basis and in the form prescribed by the Auditor-General to the following, as applicable to each government:

- Ministry of Finance, Islamabad
- Department of Finance, Punjab
- Department of Finance, Sindh
- Department of Finance, N.W.F.P.
- Department of Finance, Balochistan
- AGPR, Islamabad
- AG, Punjab
- AG, Sindh
- AG, N.W.F.P.
- AG, Balochistan.

---

### 6.3.4 Monthly reconciliation

- 6.3.4.1 A monthly reconciliation of bank accounts is a necessary part of financial management and is also an effective measure for detecting and deterring fraud and irregularities.
- 6.3.4.2 Every DAO shall prepare a monthly reconciliation statement for expenditures and receipts, as set out in direction 6.3.5.1.
- 6.3.4.3 The respective Accountant General shall prepare a consolidated monthly reconciliation statement for each government bank account, as set out in direction 6.3.5.2.

### 6.3.5 Monthly reconciliation statement

- 6.3.5.1 Each DAO will prepare and provide the following monthly reconciliation statement to the Accountant General.

#### Outline of DAO Monthly Reconciliation Statement

##### Expenditure

Total expenditure as per DAO's General Ledger	X
Less: Unpresented (uncleared) cheques/payments:	
Item 1	
Item 2	
Sub-total	X
Add: Payments or transfers in bank statement/ schedule but not in DAO's General Ledger:	
Item 1	
Item 2	
Sub-total	<u>X</u>
Adjusted total expenditure of DAO's General Ledger	X
Total expenditure as per MMDBS	<u>X</u>

##### Receipt

Total receipts as per DAO's General Ledger	Y
Add: Receipts or transfers in bank statement/ schedule but not in DAO's General Ledger:	



---

Item 1		
Item 2		
Sub-total		Y <hr/>
Adjusted total receipts of DAO's General Ledger		Y <hr/>
Total receipts as per MMDBS	Y	<hr/>

6.3.5.2 The Accountant General (AG and AGPR) will prepare a consolidated monthly reconciliation in the following format for each of the government's bank account with the SBP under their jurisdiction.

**Outline of AG Monthly Reconciliation Statement  
for account -----**

Cash balance as per Accountant General	X
Add: Unpresented (uncleared) cheque/payments:	
Item 1	
Item 2	
Sub-total	X
Receipts in bank statement but not in AG record:	
Item 1	
Item 2	
Sub-total	X
Less: Payments in bank statement but not in AG record:	
Item 1	
Item 2	
Sub-total	X <hr/>
Adjusted cash balance as per Accountant General	<hr/>
Cash balance as per bank statement	<hr/>

6.4 Daily Procedures

6.4.1 Daily procedures flowchart

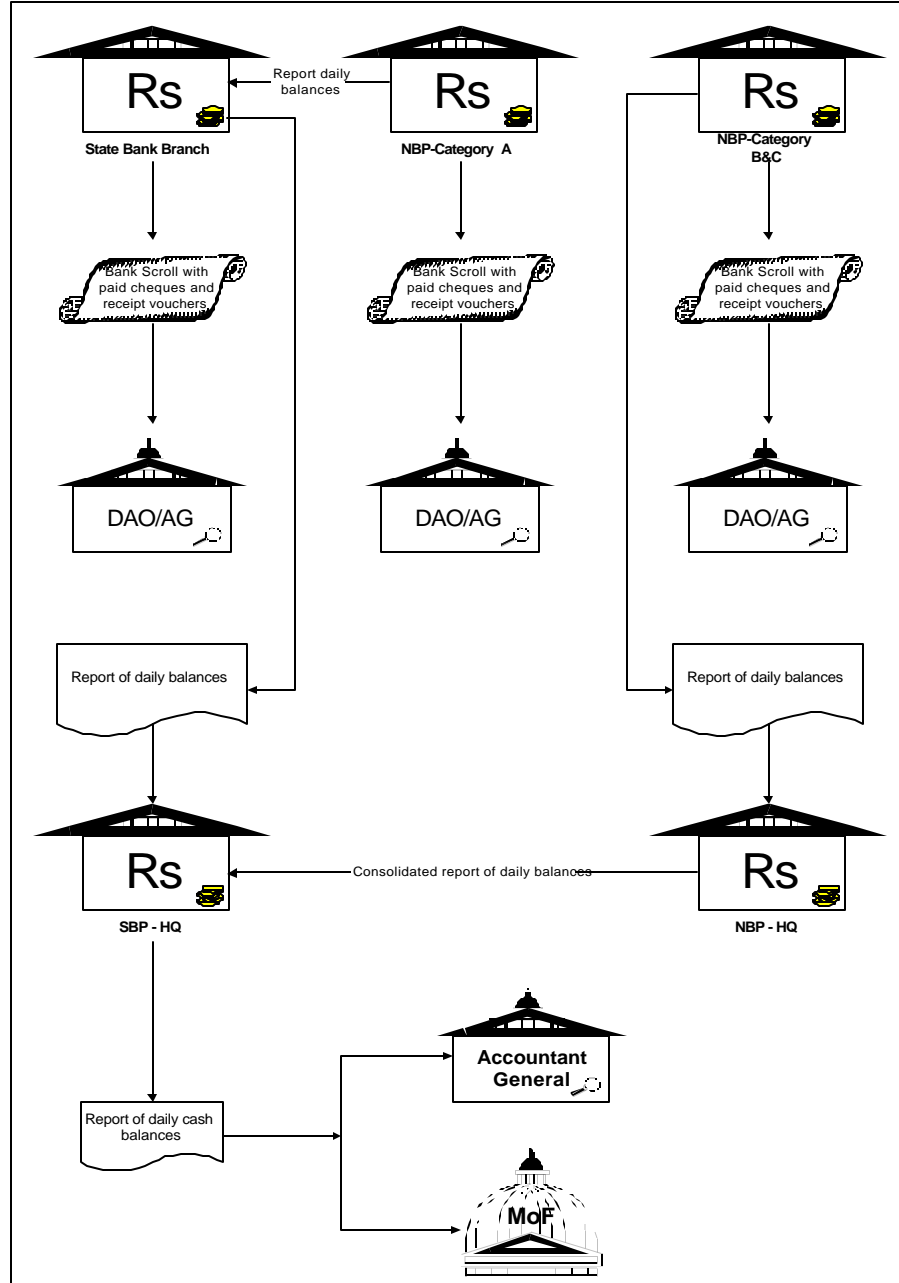

---

**6.4.2 Daily procedures by bank**

- 6.4.2.1 The Main Designated Branch (SBP branch or NBP category A branch or NBP category B branch) shall submit a daily bank return to the concerned DAO/AG/AGPR as set out in section 6.3.2.
- 6.4.2.2 The daily bank return shall include all transactions for the day and shall reach the concerned DAO/AG/AGPR by 10 a.m. next working day.
- 6.4.2.3 The Main Designated Branch shall obtain proof of delivery of the daily bank return. Where the daily bank return is personally delivered to the office of the DAO/AG/AGPR, the signature and official stamp of the officer shall be obtained. If the Main Designated Branch uses a courier service, proof of postage as per courier service voucher shall be kept.
- 6.4.2.4 Each category B and C branch of the NBP shall report (internally) the daily balances to the NBP - HQ (Head Quarter).
- 6.4.2.5 The NBP - HQ shall consolidate the daily balances received from category B and C branches and submit a consolidated report, in the prescribed form, of daily balances to the SBP - HQ.
- 6.4.2.6 The NBP - HQ shall place such internal checks and controls as necessary to ensure that all category B and C branches have submitted the daily report and shall keep a record of those branches which have not reported. The NBP - HQ shall take follow-up actions to receive daily report from such branches.
- 6.4.2.7 Each category A branch of the NBP shall report (internally) the daily balances to the designated SBP branch.
- 6.4.2.8 Each SBP branch shall submit a daily report in the prescribed form, of daily balances (including the daily balances of category A branch) to the SBP - HQ.
- 6.4.2.9 The SBP - HQ shall consolidate the information received from the NBP - HQ and SBP branches and report the daily cash balances to Accountant General and Finance Department as set out in section 6.3.3.
- 6.4.2.10 The SBP - HQ shall place such internal checks and controls as necessary to ensure that all SBP branches and the NBP - HQ have submitted the daily report on time and shall keep a record of those SBP branches which have not reported. The SBP - HQ shall take follow-up actions to receive daily report from such branches.

**6.4.3 Daily procedures by DAO/AG/AGPR**

- 6.4.3.1 At the end of each day the DAO/AG/AGPR office shall send payment advice notes (as laid down in Chapter 4) to the Main Designated Branch of the bank it deals with.
- 6.4.3.2 On receiving the daily bank returns from the Main Designated Branch, the delegated officer in the Account Section of the DAO/AG/AGPR shall carry out the following checks:
- supporting documents detail (i.e. paid cheques, receipt vouchers, transfer advice) agrees with the bank scroll
  - bank scroll entry agrees with a payment advice note entry previously sent to the Main Designated Branch of the bank.
- 6.4.3.3 Where there are any discrepancies in the bank scroll, the officer shall immediately inform the Main Designated Branch and resolve any differences in writing.
- 6.4.3.4 The delegated officer shall make note of those payments which have not yet been cleared by the bank and check these payments against the daily bank returns until they are cleared or have passed their encashment time limit.
- 6.4.3.5 The delegated officer in the DAO/AG/AGPR office shall also update the cheque register as laid down in Chapter 4.

6.5 Monthly Procedures

6.5.1 Monthly procedures flowchart

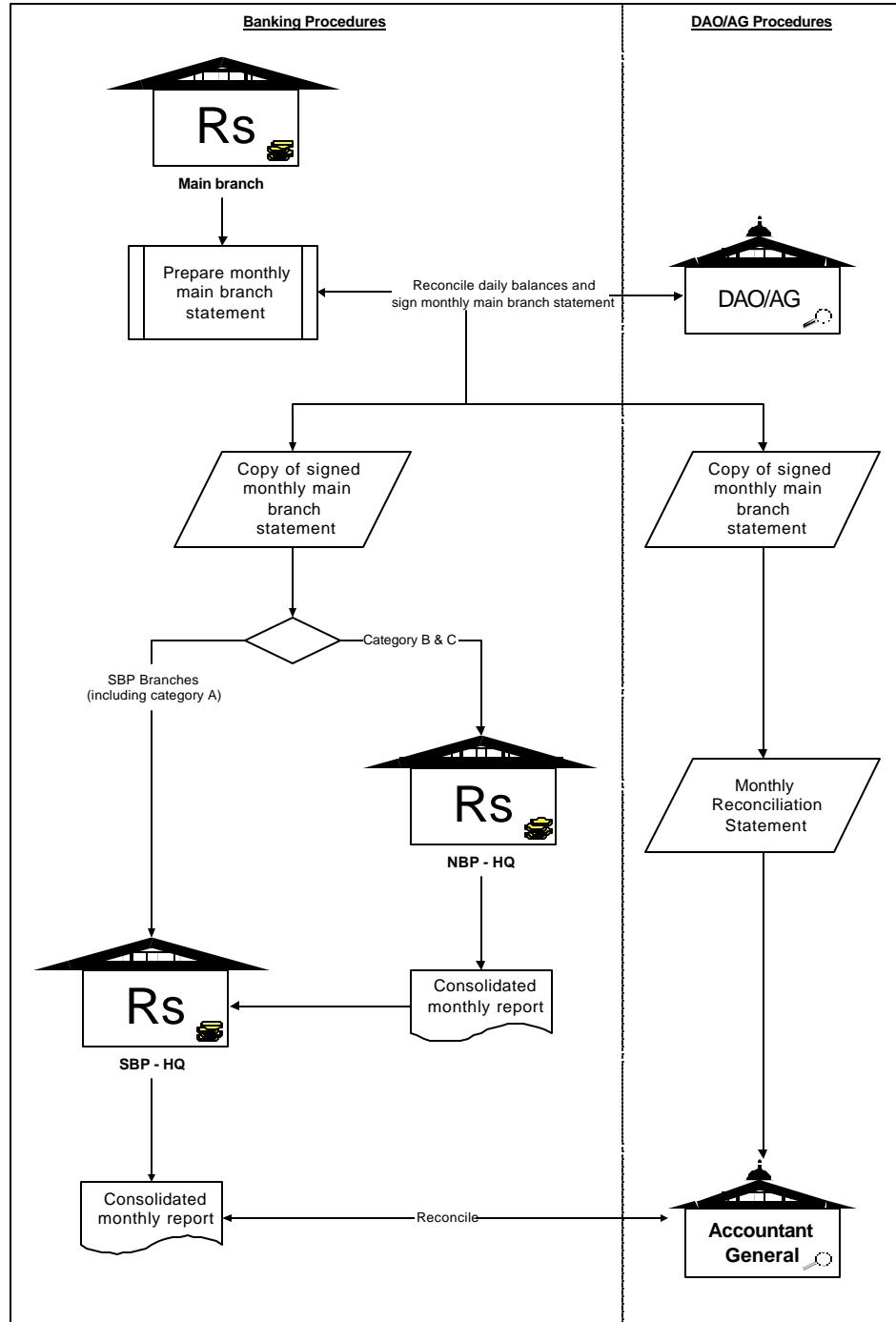

---

## 6.5.2 Monthly procedures by bank

- 6.5.2.1 The Main Designated Branch (SBP branch or NBP category A branch or NBP category B branch) shall prepare a “Monthly Main Designated Branch Statement” (form 6B) of daily balances of receipts and expenditures for each government bank account.
- 6.5.2.2 The Monthly Main Designated Branch Statement shall be sent to the concerned DAO/AG/AGPR by 2<sup>nd</sup> of the following month. The delegated officer in the DAO/AG/AGPR shall sign and stamp the statement once he/she agrees with the daily balances and send a copy back to the Main Designated Branch within 2 working days of receiving the statement.
- 6.5.2.3 Where the NBP category A (Main Designated Branch) uses NBP category B & C branches then the NBP category B & C branches will report to the Main Designated Branch.
- 6.5.2.4 The category A branch of the NBP shall send a signed copy of the Monthly Main Designated Branch Statement to the designated SBP branch.
- 6.5.2.5 The SBP branch shall agree the daily balances reported in this statement with the daily balances received earlier during the month from that category A branch.
- 6.5.2.6 Once the daily balances are verified, the SBP branch shall submit a monthly report in the prescribed form, of daily balances (including the balances of category A branch) to the SBP - HQ by 6<sup>th</sup> of the following month.
- 6.5.2.7 The SBP - HQ shall consolidate the information received from the NBP - HQ and SBP branches and shall submit a “SBP Consolidated Monthly Report” in the prescribed form (form 6C) , of daily balances to the concerned Accountant General by 8<sup>th</sup> of the following month.
- 6.5.2.8 The SBP - HQ shall place such internal checks and controls as necessary to ensure that all SBP branches and the NBP - HQ have submitted the monthly report on time. The SBP - HQ shall take follow-up actions to receive the monthly report from such branches and from the NBP - HQ.
- 6.5.2.9 The SBP - HQ shall obtain proof of delivery of the monthly report to the Accountant General. Where the monthly report is personally delivered to the office of the Accountant General, the signature and official stamp of the officer shall be obtained. If the SBP - HQ use a courier service, proof of postage as per courier service voucher shall be kept.

---

**6.5.3 Monthly procedures by DAO/AG/AGPR**

- 6.5.3.1 On receiving the Monthly Main Designated Branch Statement from the Main Designated Branch, the delegated officer in the Account Section of the DAO/AG/AGPR shall reconcile the daily balances of receipts and expenditures with its own records (Sub Ledger/General Ledger), including the daily balances as reported on the daily bank scrolls.
- 6.5.3.2 The delegated officer shall investigate individual items only where the daily balances do not agree and shall take into account the main reasons of any differences (e.g. misclassification).
- 6.5.3.3 Where differences arise the delegated officer shall compare the daily transactions on the General Ledger with the MDMBS and identify those entries which are on the General Ledger but not on the MDMBS and visa versa. The entries found on one record but not on the other will constitute the differences and form part of the reconciling items for the bank reconciliation purpose.
- 6.5.3.4 The delegated officer shall sign and stamp the statement once he/she agrees with the daily balances and shall send a copy back to the Main Designated Branch within 2 working days of receiving the statement.
- 6.5.3.5 On the basis of the Monthly Main Designated Branch Statement/General Ledger, the DAO shall prepare and sign a “DAO Monthly Reconciliation Statement”, as outlined in section 6.3.5.1, for receipts and expenditures and shall submit this statement to the Accountant General by 7<sup>th</sup> of the following month along with the monthly accounts of the DAO office.
- 6.5.3.6 A signed copy of the Monthly Main Designated Branch Statement (signed by both the Main Designated Branch manager and the DAO/AG/AGPR) shall be sent to the Accountant General with the DAO Monthly Reconciliation Statement and along with any supporting schedule to indicate exceptions in daily balances.
- 6.5.3.7 The Accountant General shall consolidate the information received from the DAOs and prepare an “AG Consolidated Monthly Report” (form 6E) of total balances of expenditures and receipts.
- 6.5.3.8 The delegated officer in the office of the Accountant General shall agree the SBP Consolidated Monthly Report, sent by the SBP - HQ, to the AG Consolidated Monthly Report prepared by his/her office.
- 6.5.3.9 The delegated officer in the office of the Accountant General shall investigate daily figures only if monthly balances do not agree. The officer shall prepare a “Daily Balances Exception List” (form 6F)

which lists down daily balances reported in the AG Consolidated Monthly Report but not in the SBP Consolidated Monthly Report, or vice versa.

6.5.3.10 The delegated officer shall send a copy of the Daily Balances Exception List to the SBP - HQ in order to reconcile the differences, and shall take the necessary follow-up actions in consultation with the Accountant General.

6.5.3.11 On the basis of the AG Consolidated Monthly Report, the delegated officer shall prepare an “AG Monthly Reconciliation Statement”, as outlined in section 6.3.5.2, for each government bank account.

**6.5.4 Summary of bank reconciliation by Accountant General**

6.5.4.1 The following diagram summarises the bank reconciliation process carried out by the Accountant General.

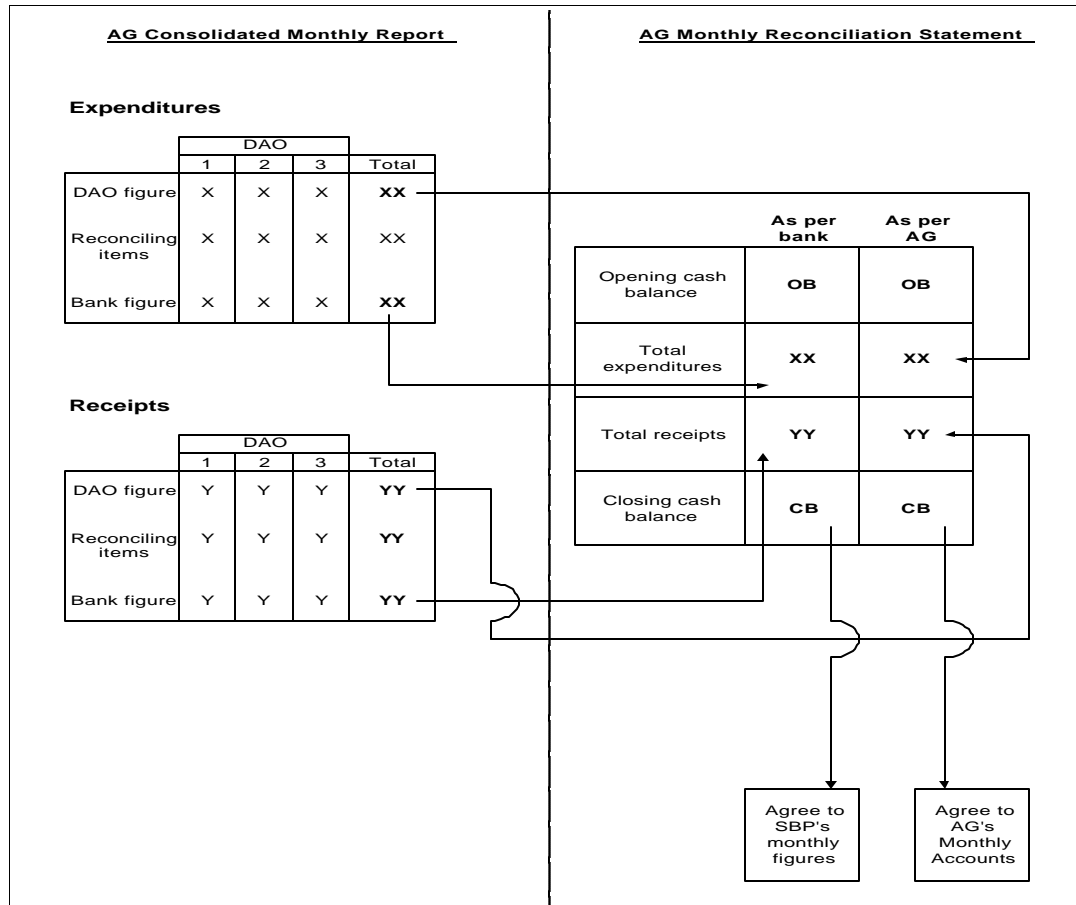



# **7 Financial Reporting Procedures**

---

## Table of Contents

<b>7.1</b>	<b>Introduction</b>	<b>7.3</b>
<b>7.2</b>	<b>General Policies</b>	<b>7.4</b>
7.2.1	Overview	7.4
7.2.2	Production of Monthly Accounts	7.5
7.2.3	Production of Consolidated Monthly Accounts	7.6
7.2.4	Production of Annual Accounts	7.6
7.2.5	Production of Combined Annual Accounts of the Federation	7.7
7.2.6	Production of Annual Appropriation Accounts	7.7
7.2.7	Production of other financial reports	7.8
<b>7.3</b>	<b>Year-end accounting policies</b>	<b>7.9</b>
7.3.1	Closure of accounts	7.9
7.3.2	Rectification of errors	7.10
<b>7.4</b>	<b>Detailed Procedure</b>	<b>7.11</b>
7.4.1	Introduction	7.11
7.4.2	Production of Monthly Accounts	7.13
7.4.3	Year-end adjustments	7.15
7.4.4	Production of Annual Accounts	7.15
7.4.5	Production of Combined Annual Accounts of the Federation	7.16
7.4.6	Production of Annual Appropriation Accounts	7.17

## **7.1 Introduction**

- 7.1.1.1 This chapter covers the procedures to be followed in the production of financial reports in accounting offices, including the Auditor-General's office, Provincial AG offices, AGPR and DAOs.
- 7.1.1.2 Centralised Accounting Entities are required to produce (through DAO/AG/AGPR) their financial reports in accordance with the procedures set out in this chapter and the format specified in the Financial Reporting Manual.
- 7.1.1.3 Self Accounting Entities are required to produce their final reports as specified in the Financial Reporting Manual. Procedures by way of guidelines are set out in Chapter 9 in respect of Self Accounting Entities.
- 7.1.1.4 Centralised Accounting Entities and Self Accounting Entities will both adhere to the same format as specified in the Financial Reporting Manual.
- 7.1.1.5 Exempt Entities will be required to report key financial information as prescribed in the Manual of External Reporting Requirements.

7.2 General Policies

7.2.1 Overview

7.2.1.1 The following diagram represents the consolidation and reporting process undertaken by the various accounting offices, including AG, AGPR and DAOs.

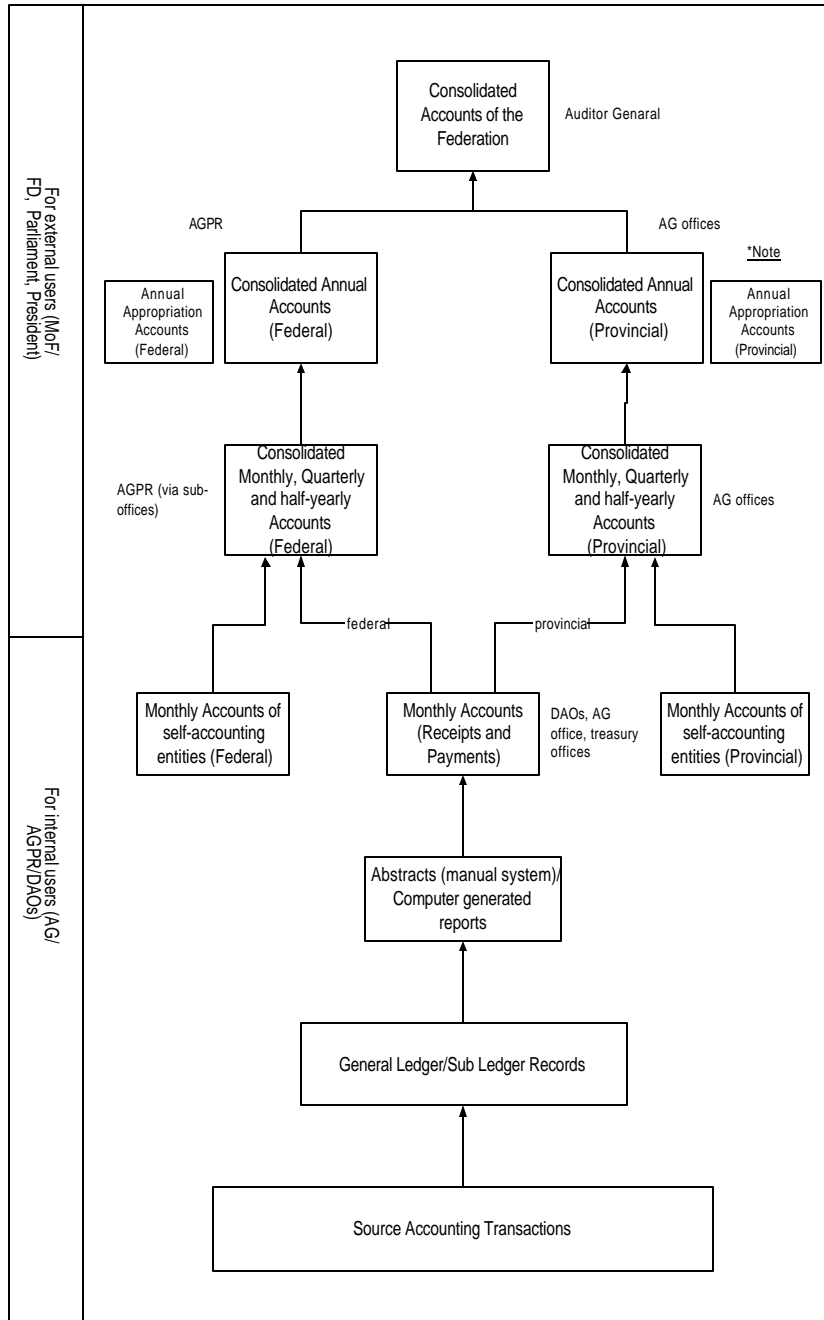

\*Note: This would include reporting (as an appendix) by Exempt Entities as stated in 7.1

---

7.2.1.2 The previous diagram represents the overall reporting framework, in which source transactions recorded at DAOs/AG/AGPR level are consolidated to produce:

- Monthly, Quarterly and Half-yearly Accounts - used to provide balances of receipts and payments for the Federal and each of the Provincial Governments
- Annual Accounts - used to provide annual statements of receipts and payments, assets and liabilities of the Federal and each of the Provincial Governments
- Combined Annual Accounts - used to provide consolidated statements of receipts and payments, assets and liabilities for the Federation as a whole, incorporating the Federal Government and each of the Provincial Government's figures.

## **7.2.2 Production of Monthly Accounts**

7.2.2.1 A separate Monthly Account shall be produced by the DAO for the Consolidated Fund and the Public Account for both the Federal and Provincial Governments.

7.2.2.2 The Monthly Accounts submitted by DAOs and self-accounting entities shall be a statement of receipts and payments by entity and object, recorded in that month, according to the chart of accounts classifications. The format for the Monthly Accounts is shown in Section 2.3 of the Financial Reporting Manual.

7.2.2.3 The timetable for the submission of the Monthly Accounts will be determined by the Accountant General/AGPR. Any delays should be reported to the Accountant General as soon as possible with valid reasons, in writing, of such delays and the date on which the accounts are expected to be submitted.

7.2.2.4 Where the due date for submitting the Monthly Accounts falls on a public holiday, the accounts are to be submitted on the following working day.

7.2.2.5 The submission of Monthly Accounts by DAOs and self-accounting entities by the prescribed date shall not be achieved by early closure of the books in that office prior the last working day of the month.

7.2.2.6 Certain General Ledger accounts are required to be cleared on a monthly basis, including suspense accounts, settlement accounts, and exchange accounts. This is referred to in chapter 16 of this Manual, 'General Accounting Procedures' and chapter 12, 'Transactions between Government Entities'.

---

### **7.2.3 Production of Consolidated Monthly Accounts**

7.2.3.1 The Accountant General's offices (including AGPR) are responsible for consolidating the accounts submitted by DAOs and self-accounting entities, into the 'Consolidated Monthly Accounts'. These accounts shall be submitted to the Auditor-General and to the respective Finance Division/ Department by 15th of the following month.

7.2.3.2 The format for the Consolidated Monthly Accounts is shown in Section 2.2 of the Financial Reporting Manual.

### **7.2.4 Production of Annual Accounts**

7.2.4.1 Under Article 9 (4) of the Audit and Accounts Order 1973, the Annual Accounts of the Federal Government and each of the Provincial Government shall be produced by the Auditor-General (through the respective Accountant General's offices).

7.2.4.2 The Accountant Generals offices shall produce the Annual Accounts by consolidating the Monthly Accounts submitted by DAOs and self-accounting entities and its own accounts and incorporating adjustments and other financial information as required by the AG.

7.2.4.3 The Annual Accounts is an annual summary of the overall financial position of each Government as at the end of the financial year. This shall include, for each Government:

- a statement of assets and liabilities. This will include comparison with last years actuals.
- a statement of receipts and payments for each fund (ie. consolidated fund, public account)
- a statement of cashflows
- a statement of receipts and payments for each of the trust accounts included under the Public Account
- notes to the Accounts.

7.2.4.4 Each year, the Accountant General will issue instructions which set out the detailed arrangements for closure of the accounts for the year. These instructions will include cut-off times for lodgement of final accounts, adjustments and other information required to compile the Annual Accounts.

7.2.4.5 The Accountant General will issue instructions to the banks (NBP/SBP) to ensure that all receipts collected and payments made in the current financial year are promptly reported to the concerned accounting offices by the prescribed date, prior to the closure of the accounts.

---

7.2.4.6 The Annual Accounts shall be submitted by the Auditor- General to the National Assembly, with a copy to Finance Division by 20<sup>th</sup> August following the close of the financial year. In the case of Provincial Government, Annual Accounts are submitted to the Provincial Assembly, with a copy to the respective Finance Department, as prescribed in the GFR regulations.

7.2.4.7 The formats required for the Annual Accounts is shown in Chapter 3 of the Financial Reporting Manual.

## **7.2.5 Production of Combined Annual Accounts of the Federation**

7.2.5.1 Under Article 10 of the Audit and Accounts Order 1973, the Auditor-General shall produce a General Financial Statement, consisting of a summary of the information from the Annual Accounts of the Federal Government and each of the Provincial Governments. This statement is referred to the Combined Annual Accounts of the Federation.

7.2.5.2 The formats required for the Combined Annual Accounts of the Federation is shown in Chapter 3 of the Financial Reporting Manual.

7.2.5.3 The Combined Annual Accounts of the Federation shall be submitted by the Auditor-General to the President, with a copy to Finance Division by 30<sup>th</sup> September following the close of the financial year.

## **7.2.6 Production of Annual Appropriation Accounts**

7.2.6.1 Under Article 9 (4) of the Audit and Accounts Order 1973, the Annual Appropriation Accounts of the Federal Government and each of the Provincial Governments shall be produced by the Auditor-General (through the respective Accountant Generals/AGPR).

7.2.6.2 The Annual Appropriation Accounts is a comparative summary of annual expenditures against budget for each grant as specified in the Schedule of Authorised Expenditure. For detail format and contents of the annual accounts refer to chapter 3 of the FRM.

7.2.6.3 The Annual Appropriation Accounts shall identify significant variations from budget and include explanations for these variances, given by the concerned spending entities.

7.2.6.4 The Annual Appropriation Accounts shall be submitted by the Auditor-General to the President, with a copy to Finance Division by 30<sup>th</sup> September following the close of the financial year. In the case of Provincial Government, Appropriation Accounts are submitted to the Governor, with a copy to the respective Finance Department.

7.2.6.5 Self-accounting entities shall prepare their own Annual Appropriation Accounts, however their summarised balances shall be included in the Annual Appropriation Accounts produced by the AG/AGPR.

7.2.6.6 The format for the Annual Appropriation Accounts is shown in Chapter 3 of the Financial Reporting Manual.

### **7.2.7 Production of other financial reports**

7.2.7.1 Other reports are required to be produced by the accounting offices (AG/AGPR/DAOs) at various intervals. These reports are specified in the Financial Reporting Manual and include the following:

- revenue confirmation statement
- disbursement confirmation statement
- division/department statement
- exchange and settlement control account
- debt report
- losses report.



---

## 7.3 Year-end accounting policies

### 7.3.1 Closure of accounts

- 7.3.1.1 The accounts of each year will be formally closed at the close of business on 30th June. No adjustments for a prior financial year will be permitted unless they are for:
- receipts collected at the bank prior to 30 June, but not received on the bank scrolls until after 30 June
  - payments made prior to 30 June but not entered into the accounts
  - inter-entity adjustments between departments and Governments relating to the previous year, as indicated in Chapter 12 of this Manual 'Transactions between Government Entities'
  - adjustments to asset and liabilities amounts, relating to the previous year
  - any other adjustments so authorised by the Accountant General.
- 7.3.1.2 At the close of the financial year, the balances contained in the General Ledger accounts for revenue expenditures and revenue receipts of the Consolidated Fund shall be closed to the revenue surplus/deficit account. Any subsequent adjustments made to these accounts of that year shall also require a closing journal entry.
- 7.3.1.3 Public Account balances are carried forward into the following, financial year, however any adjustments relating to a previous financial year shall be made through journal entry.
- 7.3.1.4 The Accountant General will formally advise Ministries and Departments of the cut-off date for the lodgement of claim vouchers for payment processing at the DAO/AG/AGPR in the current financial year. No claim voucher submitted after this date will be admitted unless approved by the Accountant General.
- 7.3.1.5 Should a claim voucher be received at the DAO/AG/AGPR in which payment is not due until the new financial year (ie. after 1 July), the payment will not be issued, and therefore recognised in the accounts, until the new financial year.
- 7.3.1.6 As provided for in Chapter 4 of this Manual, all outstanding commitments made during that year shall be duly scrutinised by the MoF/AG, and provision made in next year's appropriation to allow for the reinstatement of valid commitments in the next financial year (Direction 4.3.3.8).

---

7.3.1.7 The unspent balance of all advances, with the exception of the following advances, as advised by the MoF, must be repaid before 30 June each year:

- petty cash advances (these must be reimbursed as at 30 June)
- advances of salary, travelling allowances etc.
- mobilisation advances
- secured advances
- contractual advances.

### **7.3.2 Rectification of errors**

7.3.2.1 Errors or omissions found prior to the cut-off date for production of the Annual Accounts may be made by way of journal entry, submitted to the respective AG/AGPR offices for approval. Such errors or omissions typically include:

- mis-classification of accounts, usually requiring an adjustment between heads
- failure to record a receipt, payment or adjustment in the accounts during the year, as identified in the bank reconciliation

7.3.2.2 In interpreting the above Direction, an error or omission is considered to be material if:

- it exceeds 10% of the reported expenditure or revenue reported against a particular head
- it affects the opening cash balance of the entity/government.

7.3.2.3 Where the error affects the opening cash balance of the entity/government, the opening cash balance in the new financial year will be adjusted and the following information disclosed in the Annual Accounts and the Combined Annual Accounts of the Federation (as the case may be) of the new financial year in which the adjustment was made:

- a description of each material error and the financial effect of the error
- description of the accounts which has been adjusted due to that errors
- opening cash balance before (as reported in last year's accounts) and after the adjustment
- a statement that the error was found after last year's accounts were closed and published.

## **7.4 Detailed Procedure**

### **7.4.1 Introduction**

7.4.1.1 This section describes the procedures to be followed for producing monthly and annual reports in the AG/AGPR offices.

7.4.1.2 Procedures for consolidation of financial information laid out in this section are largely based on manual operations. In a fully computerised environment the consolidation process is facilitated by computer generated reporting.

7.4.1.3 The recording of accounting transactions, such as receipts, payments and inter-entity adjustments is covered in the respective chapters of this Manual.

7.4.1.4 The key controls to be followed in the production of financial reports are as follows:

- accounts must be submitted to the AG/AGPR in the prescribed format, by the date set by the Accountant General.
- proper review of financial information at DAO level must take place prior to the consolidation and reporting of monthly accounts. This includes reconciliation of accounting records with other sources (eg. banks, DDOs) and internal verification of accounting records and totals.
- the Consolidated Monthly Accounts, Annual Accounts and the Combined Annual Accounts shall maintain a proper audit trail, in which summarised balances can be traced to general ledger and source transaction details.

7.4.1.5 The following diagram shows how the elements of the chart of accounts are summarised through the monthly consolidation and reporting process.

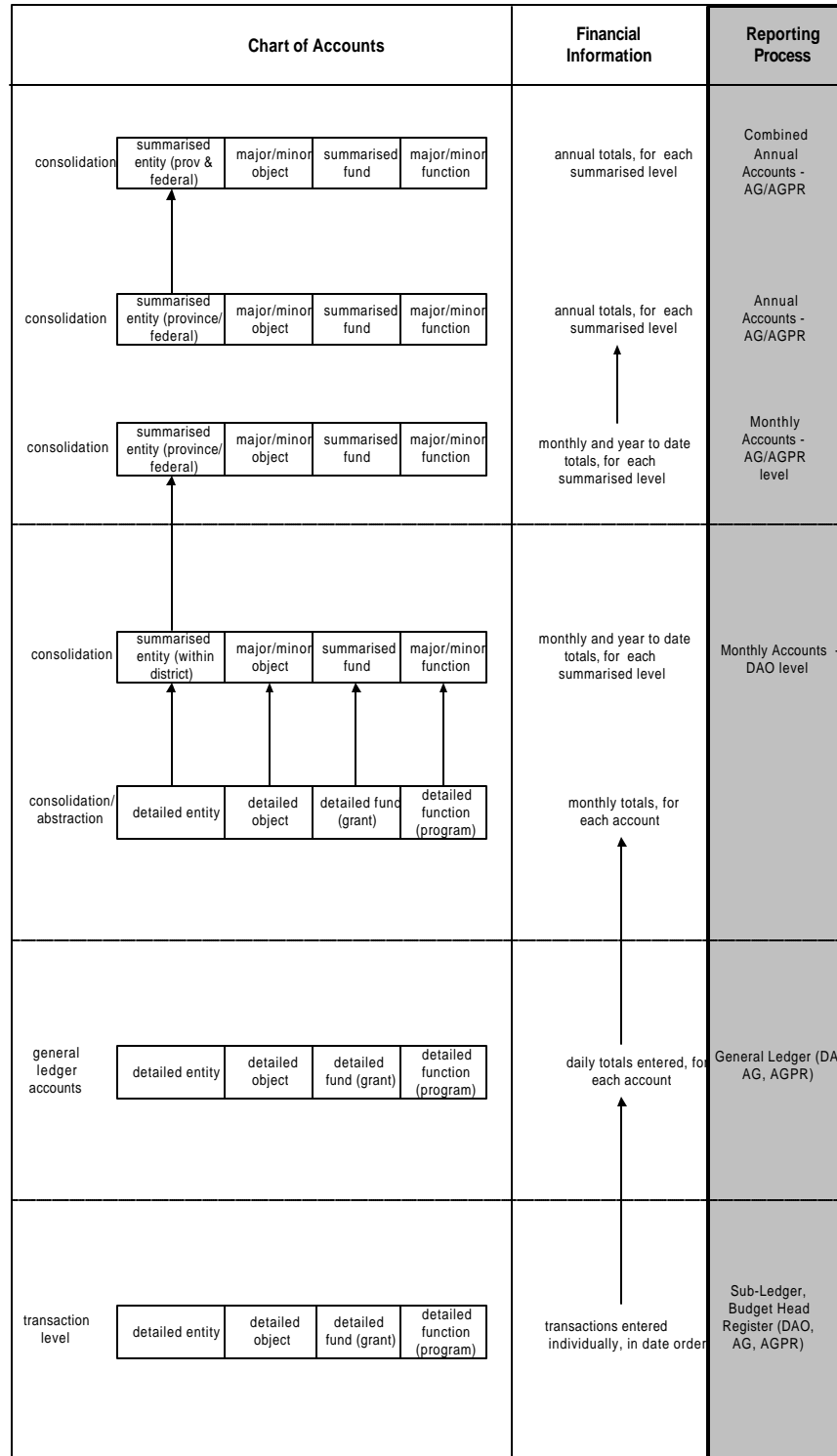

---

## 7.4.2 Production of Monthly Accounts

- 7.4.2.1 **DAO level** - Each DAO shall produce Monthly Accounts in accordance with Section 7.2.1.2 of this Chapter. This also applies to accounting offices at Federal and Provincial head quarter level (i.e. AGPR and AG own offices).
- 7.4.2.2 The Monthly Accounts prepared by DAO/AG/AGPR is a summarised entity-cum-object classification of expenditures and receipts, by minor heads of accounts, recorded during the month in that office, in accordance with the format set out in the Financial Reporting Manual.
- 7.4.2.3 Where the DAO is operating computerised accounts, the Monthly Accounts shall be obtained from a computer generated report of General Ledger balances for the relevant month. These reports will then be submitted to AG/AGPR via electronic media.
- 7.4.2.4 Where the DAO operates a manual system, the Monthly Accounts shall be obtained from consolidation of the records contained in the General Ledger of the DAO. The date-wise account totals in the General Ledger shall be consolidated into monthly totals and then summarised by entity and object code, as prescribed in section 2.3 of the Financial Reporting Manual.
- 7.4.2.5 Where the AG/AGPR office requires multiple element views (i.e. power to request additional information) of the monthly financial information from DAOs, in addition to the entity by object view identified in Direction 7.4.2.2, the manually operated DAOs/SAEs shall prepare a detailed abstract of account balances by entity, object, fund and function at the required level, and submit this to the AG/AGPR.
- 7.4.2.6 The DAO shall not submit their Monthly Accounts to the respective AG/AGPR office unless it has first undertaken the following checks:
- entity-wise receipts and expenditure records in the Payments summary (consolidated from the General Ledger) agrees with DDO -expenditure records signed-off with the respective spending departments/DDOs
  - daily balances of receipts and expenditures for the month (as recorded in the Sub-ledger) reconciles with the monthly main branch statement received from the bank branch dealing with the DAO
  - the totals produced from consolidation have been independently checked with the General Ledger and source records

- 
- the debits and credits in the General Ledger of the DAO are in balance, and agree with the Sub-ledger.

7.4.2.7 **AG/AGPR level** - Each AG office and AGPR shall produce a Consolidated Monthly Account in accordance with Section 7.2.3 of this Chapter. The AG/AGPR shall consolidate the following:

- Monthly Accounts submitted by DAOs (in the case of AGPR, via the AGPR sub-offices), either in manual or computer-generated format. Those Monthly Accounts received from manual DAO sites shall be keyed into the AG/AGPR computer system to ensure complete consolidation of balances.
- Monthly Accounts relating to the AG/AGPR own office
- Monthly Accounts submitted by self-accounting entities
- inter-Government adjustments

7.4.2.8 The AG/AGPR shall consolidate the entity information from district level to Province/Federal level. For example the consolidated report will provide object-wise analysis for a particular Ministry or Department, and a similar analysis for each of the attached Departments of a Ministry. The Consolidated Monthly Accounts shall include year to date analysis of actual receipts and expenditures. The consolidation shall occur at two levels, initially at sub office level (AGPR Islamabad / Pre audit is treated as a sub office) and subsequently at AGPR level.

7.4.2.9 The AG/AGPR office shall perform the following checks when producing Consolidated Monthly Accounts:

- the Monthly Accounts submitted by DAOs and equivalent offices are accompanied by a signed DAO Monthly Reconciliation Statement (as provided in Chapter 6 of this Manual, 'Bank Reconciliation') plus any other supporting documents required by the AG/AGPR
- the AG/AGPR must produce the AG Monthly Reconciliation Statement (as provided in Chapter 6 of this Manual, 'Bank Reconciliation') prior to the production of Monthly Consolidated Accounts
- the amounts consolidated by the AG/AGPR are independently verified with the Monthly Accounts submitted to that office
- all Monthly Accounts submitted by DAOs and self-accounting entities are in the required format and at the required level of detail, as laid down in the Financial Reporting Manual
- independent confirmation of balances is obtained from those Divisions whose accounts have been consolidated

- independent confirmation of revenues has been obtained from Central Board of Revenue (CBR)

7.4.2.10 Where the consolidation of Monthly Accounts in AG/AGPR is computerised, the information submitted by DAOs and self-accounting entities into the computer system by an authorised officer in the AG/AGPR. This data entry shall be checked by a independent officer. Where the DAO is also computerised, the Monthly Accounts information may be transferred electronic ally.

### **7.4.3 Year-end adjustments**

7.4.3.1 Year end adjustments will be made in accordance with the policy laid down in Section 7.3 of this chapter ‘Year-end accounting policies’.

7.4.3.2 Where a year end adjustment is identified, after the close of the financial year, but prior to the production of Annual Accounts, this shall be communicated formally to the AG/AGPR by the relevant DAO or self-accounting entity requesting the adjustment.

7.4.3.3 The journal entry associated with each year end adjustment shall be prepared using Form 4F by the requesting officer in the DAO/self-accounting entity. This form will indicate the double entry journal required to recognise the adjustment in the accounts. The completed journal entry form shall be sent to the respective AG/AGPR prior to the cut-off date set by the Accountant General.

7.4.3.4 All year-end adjustments must be approved by the Accountant General prior to entry into the books of account or computerised system (as the case may be). The requesting officer shall be advised by the AG/AGPR office when the journal entry has been approved and entered, (or rejected, with reasons for refusal).

7.4.3.5 The AG/AGPR shall maintain a register of year end adjustments performed, with each adjustment represented by a unique sequential journal entry number for that office.

### **7.4.4 Production of Annual Accounts**

7.4.4.1 Each AG office and AGPR shall produce the Annual Accounts for the respective Provincial and Federal Governments in accordance with the policy laid down in Section 7.2.4 of this Chapter.

7.4.4.2 The Annual Accounts shall not be produced until the accounts have been closed for the financial year, all end-of-year adjustments have been made and all Monthly Accounts received by DAOs and self-accounting entities. The AG/AGPR must also produce the

---

Consolidated Monthly Accounts for June before producing the Annual Accounts.

7.4.4.3 The general procedure for each of the main components of the Annual Accounts is provided below:

7.4.4.4 **Statement of Receipts and Payments** - The information required for this statement shall be obtained from the year-to-date information provided in the Consolidated Monthly Accounts, and then classified according to the format set down in the Financial Reporting Manual.

7.4.4.5 **Statement of Assets and Liabilities** - This report shall be produced by consolidating the cumulative balances held in the various assets and liabilities accounts into the required classification and format, as set down in the Financial Reporting Manual.

7.4.4.6 Separate statements of Assets and Liabilities will be produced for Government of Pakistan (or Provincial Government as the case may be), and the various trust heads and special deposit accounts held in the Public Account of each Government.

7.4.4.7 A trial balance report shall be produced, indicating the closing balances of all asset and liability accounts, at detail level for the Federal or Provincial Government (as the case may be).

7.4.4.8 The trial balance report shall be reviewed by the Accountant General, and if satisfied that no further adjustments are required, shall authorise the consolidated statement of assets and liabilities to be produced.

7.4.4.9 **Cashflow Statement** - this report shall be derived from the Statement of Receipts and Payments, and presented in the format prescribed in Chapter 3 of the Financial Reporting Manual.

#### **7.4.5 Production of Combined Annual Accounts of the Federation**

7.4.5.1 The Auditor-General's office shall prepare this report by consolidating the financial information contained in each of the Annual Accounts prepared for the Federal Government and each of the Provincial Governments.

7.4.5.2 This report shall include a consolidated statement of receipts and payments and a consolidated statement of assets and liabilities, both in the required classification and format, as set down in the Financial Reporting Manual. These statements shall show, for each line item, the balances for each Government individually as well as the total.



**7.4.6 Production of Annual Appropriation Accounts**

7.4.6.1 The AGPR and each AG office shall produce Annual Appropriation Accounts in accordance with the policy laid down in Section 7.2.6 of this Chapter.

7.4.6.2 The Annual Appropriation Accounts shall show separately:

- the Schedule of Authorised Expenditure for the year (both Original and Supplementary)
- a summarised statement showing for each grant, the original, supplementary and final budgets, the annual expenditure and variance against final budget
- an appropriation statement for voted expenditures

7.4.6.3 The AG/AGPR shall only prepare the Appropriation Accounts once the Annual Accounts have been finalised. The figures used for actual expenditures shall be drawn from the Annual Accounts. The budget figures used shall be confirmed by the respective Finance Division/ Department

7.4.6.4 The Annual Appropriation Accounts shall be signed-off by the Auditor-General, once satisfied that proper audit has been carried out on these Accounts.

# **8 Loss and Recoveries of Public Money**

---

## Table of Contents

<b>8.1</b>	<b>Introduction</b>	<b>8.3</b>
<b>8.2</b>	<b>General Policies</b>	<b>8.4</b>
8.2.1	Loss of or deficiency in public monies	8.4
8.2.2	Reporting of losses and deficiencies	8.4
8.2.3	Responsibility for losses and deficiencies	8.5
8.2.4	Write-off and waiver of losses	8.5
8.2.5	Overpayments	8.6
8.2.6	Recovery of loans and advances	8.6
<b>8.3</b>	<b>Accounting for Losses and Recoveries</b>	<b>8.7</b>
8.3.1	Recording overpayments	8.7
8.3.2	Recording losses and deficiencies	8.7
8.3.3	Accounting treatment where recoveries are certain	8.7
8.3.4	Accounting treatment where recoveries are uncertain	8.7
8.3.5	Accounting treatment where recoveries are received in following or subsequent financial year	8.8
8.3.6	Accounting treatment where recoveries are received more than the loss amount	8.8
8.3.7	Accounting entries	8.8

**8.1 Introduction**

8.1.1.1 This chapter covers the accounting policies and procedures applicable to write-offs and recoveries of public money.

8.1.1.2 This chapter also sets out policies for recovery of amounts owed on account of outstanding loans and advances given to the Provincial Governments, local bodies and government employees.

8.1.1.3 This chapter should also be read in conjunction with chapter 11 Accounting for Liabilities.

## **8.2 General Policies**

### **8.2.1 Loss of or deficiency in public monies**

8.2.1.1 A loss of or deficiency in public monies is a physical loss, caused by any reason, of any government asset or cash, or cash equivalent which is readily convertible to cash.

8.2.1.2 A loss of or deficiency in money could be due to:

- a loan becomes doubtful (e.g. due to death of an employee or bankruptcy of an entity)
- theft/misappropriation/fraud
- fire, theft or robbery
- overpayment or less recovery established as a result of audit/management review
- overpayment due to incorrect interpretation of rules
- negligence of government employee
- transit losses in commodity trade
- any other reason.

### **8.2.2 Reporting of losses and deficiencies**

8.2.2.1 Any loss of or deficiency in public monies caused by theft or otherwise, shall be immediately reported by the officer concerned (the custodian of public monies) to his/her superior officer as well as to the officer who has authority to write-off losses.

8.2.2.2 Such loss of or deficiency in public monies shall also be reported by the officer concerned to the Accountant General (apart from the following exceptions).

8.2.2.3 The exceptions are:

- in the case of Customs Revenue, mistakes in assessments or under assessments which are discovered too late to allow a supplementary claim being made
- petty cases, involving losses below Rs 1,000 each.

The above exceptions need not be reported to the Accountant General unless there are important features which merit detailed investigation and consideration.

8.2.2.4 The following action shall be taken in reporting losses of or deficiencies in public monies, known or suspected to be the result of theft, robbery or fraud committed by an officer.

- the PAO of the concerned Division/Department shall advise the Department of Finance of all such losses and deficiencies as soon as they become known
- the PAO shall also, as soon as practicable, provide the Department of Finance with a detailed report of such losses
- the Accountant General shall be advised, by the PAO, as soon as possible of a loss or deficiency where there are implications that the loss was caused or facilitated by a breakdown or weakness in accounting or control systems operating within the Division/Department.

8.2.2.5 The reporting to the Accountant General shall be carried out even when the loss or deficiency has been made good (i.e. when it is not a loss any more).

### **8.2.3 Responsibility for losses and deficiencies**

8.2.3.1 Government employees shall be held personally responsible for any loss or deficiency sustained by the Government through their theft, robbery, fraud or negligence.

8.2.3.2 Government employees shall also be held personally responsible for any loss or deficiency arising from theft, robbery, fraud or negligence on the part of any other government officer, to the extent to which it may be shown that the officer concerned contributed to the loss or deficiency by his/her own action or negligence.

### **8.2.4 Write-off and waiver of losses**

8.2.4.1 Subject to the limits and conditions specified in the Delegation of Financial Powers, a delegated officer may approve the write-off or waiver of irrecoverable public money lost by fraud, mistake, negligence of individuals or other causes, provided that:

- the loss does not disclose a defect of system, the amendment of which requires the orders of higher authority, and
- there has not been any serious negligence on the part of some government officer or officers which may possibly call for disciplinary action requiring the orders of higher authority.

In the case of above, the delegated officer can only approve the write-off or waiver once the orders of higher authority are received or

the officers found responsible for negligence have been proceeded against.

8.2.4.2 All approvals to the write-off or waiver of public monies will be communicated in writing to the Accountant General.

### **8.2.5 Overpayments**

8.2.5.1 All overpayments, immediately they are discovered, shall be informed to the delegated authority and will be communicated in writing to the Accountant General.

### **8.2.6 Recovery of loans and advances**

8.2.6.1 Recoveries of loans and advances from the Federal Governments to the Provincial Governments and local bodies are governed by special orders of the Government which must specify the terms and conditions under which loans are to be granted and repaid in each case.

8.2.6.2 Any default in the payment of interest upon a loan or advance, or in the repayment of the principal, will be promptly reported by the Accountant General to the authority which approved the loan or the advance.

8.2.6.3 On receipt of such report from the Accountant General, the authority concerned shall immediately take steps/actions to get the default remedied.

8.2.6.4 Recoveries of advances given to government employees shall be subject to periodic adjustments from their salaries in accordance with the rules applicable to each case. The approving authority (if it is within their powers) may in exceptional cases (as defined or guidelines given by the MoF) order a reduction in the amount of the monthly instalment.

8.2.6.5 Any such reduction shall be immediately communicated in writing to the Accountant General.

8.2.6.6 For detailed procedures on recovery of loans and advances, refer to Section 4.10 of Chapter 4.

### **8.3 Accounting for Losses and Recoveries**

#### **8.3.1 Recording overpayments**

8.3.1.1 Where an overpayment has been made against a head of expenditure other than Loan Account and is irrecoverable, the overpayment will remain a charge to that expenditure head.

#### **8.3.2 Recording losses and deficiencies**

8.3.2.1 All losses of or deficiencies in public monies shall be recorded by a delegated officer within the department/entity, in the "Register of Losses" (form 8A) kept for the purpose. The record will show, where appropriate:

- gross value of the loss
- cause of each loss
- the action taken
- amount recovered
- amount waived or written off and its date
- authority for adjustment.

8.3.2.2 The Accountant General shall consolidate the above information on a monthly basis in the form of Losses Report. The format of Losses Report is prescribed in section 2.2.10 of the Financial Reporting Manual.

8.3.2.3 The Accountant General shall also report the losses in the Annual Accounts as an annual statement showing the accumulated losses by category, detailing amount recovered and amount written off.

#### **8.3.3 Accounting treatment where recoveries are certain**

8.3.3.1 Where during a financial year the recovery amount of losses or deficiencies is known and recoveries are certain, the amount recovered (i.e. when recovery amount received) shall be credited to the original expenditure head.

#### **8.3.4 Accounting treatment where recoveries are uncertain**

8.3.4.1 In cases where the circumstances and ultimate amount of a loss is uncertain and the account for the financial year is still open, the amount shall be transferred to a suspense loss account pending the investigation.



8.3.4.2 Any sums recovered while the account for the financial year remains open shall be credited to that suspense loss account.

8.3.4.3 Any balance of a loss remaining in the suspense loss account when the account for the financial year is closed shall be regarded as the final amount of the loss and charged to the unrecovered losses (expenditure) head and noted accordingly.

### **8.3.5 Accounting treatment where recoveries are received in following or subsequent financial year**

8.3.5.1 Where any recoveries are made after the account for the financial year is closed, they shall be treated as other revenue in the financial year in which recovery amount is received.

### **8.3.6 Accounting treatment where recoveries are received more than the loss amount**

8.3.6.1 Where recovery amount received is more than the loss amount shown in the Register of Losses, the excess amount recovered shall be treated as other income in the financial year in which excess recovery amount is received.

### **8.3.7 Accounting entries**

8.3.7.1 The following double entries shall be carried out in relation to disclosures of recoveries of losses.

- **Where recoveries are certain during a financial year**

Dr		Bank account
Cr		Expenditure head account

[to record recoveries received during a financial year]

- **Where account for the financial year is still open**

Dr		Suspense loss account
Cr		Expenditure head account

[to transfer the loss to suspense loss account where ultimate amount of a loss is uncertain]

Dr		Bank account
Cr		Suspense loss account

[to record recoveries received]

- **On closure of account for the financial year**

Dr	Unrecovered losses (expenditure) account
Cr	Suspense loss account

[to record any net loss not recovered at the financial year end]

- **Where account for the financial year is closed**

Dr	Bank account
Cr	Other revenue account

[to record recoveries received after the account for the financial year is closed]

- **Where recoveries received are more than the loss (excess recoveries)**

Dr	Bank account
Cr	Other revenue account

[to record excess recoveries in the financial year in which the amount is received]

# **9 Self-accounting Entities**

---

## Table of Contents

<b>9.1 Introduction</b>	<b>9.3</b>
9.1.1 Overview	9.3
9.1.2 Definition of self-accounting entities	9.4
9.1.3 Self-accounting entities	9.4
9.1.4 Independent entities	9.4
9.1.5 Commercial undertakings	9.5
<b>9.2 General Policies</b>	<b>9.6</b>
9.2.1 Responsibilities	9.6
9.2.2 Expenditures and Receipts	9.6
9.2.3 Transactions with other government entities	9.6
<b>9.3 Accounting Policies</b>	<b>9.7</b>
9.3.1 General	9.7
9.3.2 Basis of accounting	9.7
9.3.3 Recognition of expenditures and receipts	9.7
9.3.4 Transactions with other government entities	9.7
9.3.5 Classification principles	9.7
9.3.6 Financial reporting requirements	9.8
9.3.7 Consolidation of self-accounting entities	9.8
<b>9.4 Accounting for Self-accounting Entity Transactions</b>	<b>9.9</b>
9.4.1 Manual accounting records	9.9
9.4.2 Computer records	9.9
9.4.3 Accounting entries for self-accounting entity transactions	9.9
<b>9.5 Detailed Procedures</b>	<b>9.10</b>
9.5.1 Introduction	9.10
9.5.2 Budgetary control procedures	9.10
9.5.3 Receipts	9.10
9.5.4 Authorisation of expenditures	9.11
9.5.5 Control of expenditures	9.11
9.5.6 Recording of fixed assets	9.11
9.5.7 Recording of inter-entity transactions	9.11
9.5.8 Reconciliation of self-accounting entity transactions	9.11
9.5.9 Reporting of self-accounting entity transactions	9.12
9.5.10 Consolidation of self-accounting entity transactions	9.12

## 9.1 Introduction

### 9.1.1 Overview

- 9.1.1.1 This chapter deals with the policies, accounting treatment and procedures for self-accounting entities.
- 9.1.1.2 The policies include both general policies and accounting policies for self-accounting entities. The general policies provide guidance on the responsibilities and banking arrangements of a self-accounting entity. The accounting policies deal with the basis of accounting, recognition, classification, reporting and consolidation of self-accounting entity transactions.
- 9.1.1.3 The accounting treatment details the records, which need to be maintained for complete and accurate recording of self-accounting entity transactions and the appropriate double entries for recording the transactions in the General Ledger.
- 9.1.1.4 The general procedures cover the budgetary control, authorisation, recording, consolidation, reporting and reconciliation of transactions generally.
- 9.1.1.5 The policies and procedures set out in other chapters of the Manual shall be applicable to self-accounting entities. This Manual highlights references in the other chapters for the key policies and procedures, which need to be followed.
- 9.1.1.6 Where a specific issue needs to be addressed the self-accounting entity shall refer to the relevant specific chapter, for example for the purchase of goods refer to Chapter 13 'Procurement and Asset Management' and Chapter 4 'Expenditures'.
- 9.1.1.7 Detailed procedures may additionally be maintained by the individual self-accounting entities.
- 9.1.1.8 The policies and procedures contained in the relevant Departmental Code, Manual or Regulations shall continue to be followed. Where these conflict with the Accounting Policies and Procedures Manual, this Manual shall prevail.
- 9.1.1.9 Wherever a government department requires the maintenance of accounting records, which are not detailed in this manual the form of the records shall be decided by the entity in consultation with the Auditor-General.

---

**9.1.2 Definition of self-accounting entities**

9.1.2.1 Self-accounting entities are those spending entities whose accounting and financial operations authority has been delegated to them, whether at Federal or Provincial Government level.

9.1.2.2 Self-accounting entities consequently maintain their own accounting records. They are required to report summarised financial information to the Accountant General's office on a monthly basis.

9.1.2.3 There are other government entities (e.g. Defence and Railways) which are within the budget sector but are independent. These entities maintain their own accounting records and submit monthly accounts to the AGPR's office for consolidation. For the purpose of accounting procedures, these entities are outside the scope of this Manual.

9.1.2.4 In addition there are a number of commercial undertakings in which the government has a stake. These entities shall submit quarterly financial accounts to the controlling government entity in the format required by the Auditor-General. For the purpose of accounting procedures, these entities are also outside the scope of this Manual.

**9.1.3 Self-accounting entities**

9.1.3.1 Refer to the Rule of Business for a full list of the current status of self-accounting entities.

9.1.3.2 Examples of self-accounting entities, at the date of issue of this Manual, are as follows (these may change over time as instructed by the Ministry of Finance and the Auditor-General):

- Ministry of Foreign Affairs
- Forest Department (Provincial)
- Public Works Department.

**9.1.4 Independent entities**

9.1.4.1 Examples of independent entities (which are self accounting entities), at the date of issue of this Manual, are:

- Ministry of Railways
- Ministry of Defence.

9.1.4.2 These independent entities shall follow the broad accounting principles as described in the MAP and shall report monthly to the AG/AGPR in the form prescribed by the Auditor-General.

9.1.4.3 These independent entities shall also reconcile their receipts and expenditures figures with the NBP/SBP on monthly basis and shall send a reconciliation statement in the form prescribed by the Auditor-General.

### **9.1.5 Commercial undertakings (Exempt Entities)**

9.1.5.1 Examples of commercial undertakings existing at the date of issue of this manual, are:

- National Highways Authority
- Karachi Electricity Supply Corporation
- WAPDA

9.1.5.2 These undertaking shall report, on annual basis, to the AG/AGPR in accordance with section 1.2.5 of the Manual of External Reporting (MERR). The form of reporting shall be in accordance with section 1.4 of the MERR or as prescribed by the Auditor-General.

## **9.2 General Policies**

### **9.2.1 Responsibilities**

9.2.1.1 Each self-accounting entity is responsible for all aspects of its own financial transactions from budgetary control, approval, certification, authorisation through to recording, reconciliation reporting and monitoring of transactions.

9.2.1.2 The Principal Accounting Officers in the self-accounting entities shall themselves be responsible for ensuring that adequate controls and corporate governance exist over transactions within the entity. This shall be evidenced by the PAO signing off each set of monthly summarised financial information.

9.2.1.3 The Accountant General's office shall be responsible for the consolidation of the monthly summarised financial information from self-accounting entities. The Accountant General shall also be responsible for overseeing that the prescribed accounting system is generally in place, and that the data provided by self-accounting entities is based on proper classification.

### **9.2.2 Expenditures and Receipts**

9.2.2.1 Self-accounting entities shall follow the general policies as detailed in Chapter 4 'Expenditures' (Section 4.2) and Chapter 5 'Receipts' (Section 5.2).

### **9.2.3 Transactions with other government entities**

9.2.3.1 Transactions involving self-accounting entities and other government entities shall follow the general policies set out in Chapter 12 'Transactions between Government Entities' (Section 12.2).



### **9.3 Accounting Policies**

#### **9.3.1 General**

9.3.1.1 Unless otherwise specified, the same accounting policies applicable to centralised entities also apply to self-accounting entities (Sections 4.3, 5.3 and 12.3).

#### **9.3.2 Basis of accounting**

9.3.2.1 Transactions forming the basis for the monthly summarised financial information reported to the Accountant General must be recorded on a modified cash basis (see Section 9.3.3) in accordance with the policies applied to centralised accounting entities.

#### **9.3.3 Recognition of expenditures and receipts**

9.3.3.1 Recognition of expenditures and receipts shall be on a modified cash basis in accordance with the policies detailed in Chapter 4 'Expenditures' (Section 4.3) and Chapter 5 'Receipts' (Section 5.3).

9.3.3.2 Expenditures shall be recognised by the entities on the date of cheque or transfer advice issue. All payments issued will be entered in the cashbook of the disbursing officer. In addition, commitments of Rs 10,000 or 10% of the budget head, whichever is higher, shall be recognised in accordance with Chapter 4.

9.3.3.3 Revenues shall be recorded on a cash basis.

#### **9.3.4 Transactions with other government entities**

9.3.4.1 Transactions involving self-accounting entities and other government entities shall follow the accounting policies set out in Chapter 12 'Transactions between Government Entities'.

#### **9.3.5 Classification principles**

9.3.5.1 Self-accounting entities are required to apply the same common Chart of Accounts as prescribed by the Auditor-General in the Chart of Accounts Manual and classification principles as detailed in the accounting policy sections of chapters in this Manual. The principles are detailed in this section and are applicable to all self-accounting entities where relevant.

**9.3.6 Financial reporting requirements**

9.3.6.1 All self-accounting entities shall report monthly summarised financial information with supporting schedules and vouchers to the relevant Accountant General.

9.3.6.2 The form in which this summarised financial information and supporting accounts is reported shall be prescribed by the Auditor-General, in accordance with the 'Financial Reporting Requirements'.

9.3.6.3 Self-accounting entities may prepare additional management information for their internal use, but these need not be submitted to the Accountant General unless specifically requested.

**9.3.7 Consolidation of self-accounting entities**

9.3.7.1 The monthly summarised financial information shall be consolidated into the Consolidated Monthly Accounts by the Accountant General's office.

## **9.4 Accounting for Self-accounting Entity Transactions**

### **9.4.1 Manual accounting records**

9.4.1.1 Manual accounting records must be maintained for expenditures and revenues as detailed in Chapters 4 and 5 (Sections 4.4 and 5.4), including:

- cash accounts shall be maintained in a cashbook to keep a record of all receipts and disbursements arising in each entity, along with supporting registers. These registers shall include the imprest cash account (refer to Section 4.2.8 of Chapter 4 'Expenditures'), temporary advance account and settlement account. The cashbook shall be supported by the Cheque Register. The Auditor-General shall prescribe the form in which these accounts are to be kept
- other supporting accounts shall be kept in the form prescribed by the Auditor-General
- additional accounts may be maintained by individual self-accounting entities for internal control purposes, but maintenance of these accounts is not a requirement of the Auditor-General.

### **9.4.2 Computer records**

9.4.2.1 Computerised records shall function for expenditures and receipts as detailed in Sections 4.4.2 and 5.4.2 of Chapters 4 and 5, respectively.

### **9.4.3 Accounting entries for self-accounting entity transactions**

9.4.3.1 Transactions reported in the monthly accounts to the Accountant General shall be in accordance with treatment detailed in the appropriate chapters of this manual.

9.4.3.2 Self-accounting entities shall follow the policies as detailed in Chapter 4 'Expenditures' (Sections 4.4) and Chapter 5 'Receipts' (Section 5.4).

9.4.3.3 Transactions involving self-accounting entities and other government entities shall be accounted for in accordance with Chapter 12 'Transactions between Government Entities'.

## **9.5 Detailed Procedures**

### **9.5.1 Introduction**

9.5.1.1 This section describes the procedures and key controls to be performed by self-accounting entities.

9.5.1.2 The processing of self-accounting entity transactions must comply with the directions laid down in previous sections of this chapter.

9.5.1.3 The following key internal controls must be observed for self-accounting entities:

- budgetary control shall be exercised over self-accounting entity funds
- money shall in general be received at SBP / NBP's
- segregation of duties between officers raising bills for payment, receiving money and recording money
- all claim vouchers must be authorised by a delegated officer within the entity incurring the expenditure
- segregation of duties between claim approval, certification, authorisation, cheque preparation and cheque signing.
- all fixed assets shall be recorded in the Fixed Asset Register
- a regular, complete and up-to-date bank reconciliation shall be performed
- source documents, registers and sub-ledgers shall be reconciled with transactions recorded in the General Ledger
- monthly financial reports must be prepared by each self-accounting entity and signed off by the PAO, for submission to the appropriate Accountant General for consolidation.

### **9.5.2 Budgetary control procedures**

9.5.2.1 All self-accounting entities are required to exercise proper budgetary control over funds, as detailed in Chapter 3 'Budgetary Control'.

### **9.5.3 Receipts**

9.5.3.1 Payments to self-accounting entities should in general be made through the State Bank and National Bank of Pakistan, in accordance with the procedures detailed in Chapter 5 'Receipts' (Section 5.5.3).

9.5.3.2 Where money is received by the Post Office these shall be in accordance with the procedures detailed in Chapter 5 'Receipts' (Section 5.5.4).

9.5.3.3 Where money is received by self-accounting entities these shall be in accordance with the procedures detailed in Chapter 5 'Receipts' (Section 5.5.5).

9.5.3.4 There shall be segregation of duties between those officers raising demands for payment, those receiving monies and those recording the transaction.

#### **9.5.4 Authorisation of expenditures**

9.5.4.1 All expenditure shall be approved, certified and authorised by delegated officers within the self-accounting entity, in accordance with the policies and procedures detailed in Chapter 4 'Expenditures'.

9.5.4.2 There shall be segregation of duties between those officers involved in the processing of the expenditure claim and those signing the payment.

#### **9.5.5 Control of expenditures**

9.5.5.1 The Detailed procedures for expenditure control, outlined in the Chapter 4 'Expenditures' (Section 4.5) apply equally to self-accounting entity payments.

9.5.5.2 Payroll shall be operated in accordance with Chapter 4 'Expenditures' (Section 4.6).

9.5.5.3 Cash advances shall be in accordance with Chapter 4 'Expenditures' (Section 4.10).

#### **9.5.6 Recording of fixed assets**

9.5.6.1 The details of fixed assets shall be recorded in a Fixed Asset Register (as detailed in Chapter 13) including assets such as property and equipment both purchased and constructed by the entity.

#### **9.5.7 Recording of inter-entity transactions**

9.5.7.1 The policies, accounting treatment and procedures for transactions between self-accounting entities and other Government entities are detailed in Chapter 12 'Transactions between Government entities'.

#### **9.5.8 Reconciliation of self-accounting entity transactions**

9.5.8.1 The delegated accounts officer in self-accounting entities shall perform the same daily and monthly banking procedures undertaken by the

---

---

DAO's for centrally accounted entities, as detailed in Chapter 6. The 'DAO Monthly Reconciliation Statement' shall be the 'SE Monthly Reconciliation Statement' (form 6D) .

9.5.8.2 Supporting sub-ledgers/registers/vouchers/forms shall be reconciled with transactions reported in the monthly accounts to ensure complete and accurate reporting.

### **9.5.9 Reporting of self-accounting entity transactions**

9.5.9.1 The PAO shall produce monthly consolidated financial information in accordance with the procedures set out in Chapter 7 'Financial Reporting Procedures' (Section 7.4.2)

9.5.9.2 All self-accounting entities shall submit monthly accounts to the Accountant General (AGPR/Provincial AG). Supporting schedules and vouchers shall be provided as requested by the Accountant General.

9.5.9.3 The accounts shall be submitted in a standard format along with the supporting accounts. This shall be prescribed by the Auditor-General.

9.5.9.4 The information provided to the Accountant General must be classified according to the Chart of Accounts.

### **9.5.10 Consolidation of self-accounting entity transactions**

9.5.10.1 The summarised financial information reported each month shall be consolidated into the Consolidated Monthly Accounts by the Accountant General's office.

# 10 Project Accounting

---

## Table of Contents

<b>10.1</b>	<b>Introduction</b>	<b>10.3</b>
<b>10.2</b>	<b>General Policies</b>	<b>10.4</b>
10.2.1	Definition	10.4
10.2.2	Responsibilities	10.4
10.2.3	Classification of development projects	10.4
<b>10.3</b>	<b>Accounting Policies</b>	<b>10.6</b>
10.3.1	Mode of payment	10.6
10.3.2	Basis of accounting	10.6
10.3.3	Recognition of project expenditure	10.6
10.3.4	Commitment accounting	10.7
10.3.5	Recognition of revenue	10.7
<b>10.4</b>	<b>Accounting for Project Expenditures</b>	<b>10.8</b>
10.4.1	Accounting records	10.8
10.4.2	Commitment accounting records	10.8
10.4.3	Accounting entries	10.8
10.4.4	Reporting and consolidation of project expenditure	10.8
10.4.5	Reconciliation of project expenditure	10.9
10.4.6	Reporting of project expenditures	10.9



**Introduction**

- 10.1.1.1 This chapter covers the accounting policies and procedures applicable to the management of development projects. It is of key importance to the Government, donor agencies and other users, that the cost of all development projects undertaken by the Government be accurately measured and progressively reported.
- 10.1.1.2 Unless otherwise specified in this chapter, the general policies and procedures relating to development projects are the same as those set out in chapter 4 of this Manual, 'Expenditures'.
- 10.1.1.3 This chapter does not address the detailed procedures required for the preparation, appraisal and approval of development projects. Such procedures are set out in the 'Manual for Development Projects' and other directions issued by Ministry of Finance (Planning Commission).
- 10.1.1.4 General policies and procedures for the preparation of development project budgets are included in chapter 3 of this Manual, 'Budgetary Control Procedures'. Project managers are also required to comply with detailed guidelines for project budgeting issued by individual ministries and departments.
- 10.1.1.5 Policies and procedures for the use of assignment and personal ledger accounts, which may apply to development projects in certain instances, is provided in Chapter 17.

## **10.2 General Policies**

### **10.2.1 Definition**

10.2.1.1 A development project is defined as a scheme or activity provided within a development expenditure grant included in the Schedule of Authorised Expenditure. Development projects typically exhibit the following characteristics:

- a finite project life
- a nominated project manager
- a specified source of funding
- an approved project plan and budget
- specified deliverables

### **10.2.2 Responsibilities**

10.2.2.1 A project manager shall be appointed for each development project. This officer is responsible for both the operational and administrative components of the project. The financial powers delegated to a project manager are laid down in the 'Delegation of Financial Powers' issued by MoF.

10.2.2.2 The Project Managers are primarily responsible for the recording and accounting of the project expenditure on a daily basis. On a periodic basis the Project Manager report to the AGPR/AG in the form as prescribed in the FRM. The AGPR/AG include these project expenditure in the monthly consolidation.

10.2.2.3 The Finance Division, through the Planning Commission, is responsible for administering the project submission and approval process, through the various project approval bodies.

10.2.2.4 Ministry of Finance, through Economic Affairs Division, is responsible for the management of external and other borrowings obtained to fund development projects.

### **10.2.3 Classification of development projects**

10.2.3.1 All development project expenditure shall be recorded in the Consolidated Fund of the respective Federal and Provincial Governments.

10.2.3.2 Each development project shall be classified according to the elements contained in the Chart of Accounts. Specifically, the following classification requirements shall be followed:

- 
- development expenditure out of revenue account is distinguished from development expenditure out of capital account
  - development expenditure of each ministry or department is classified by grant number (as given in the 'fund' code in the Chart of Accounts)
  - each grant is further classified into the particular development projects under the administrative control of the ministry or department. Each development project is represented by a project number as provided in the Chart of Accounts.
  - the expenditure incurred on each development project is further classified by detailed function and object

10.2.3.3 An example of this hierarchy is as follows:

- Ministry of Food, Agriculture and Livestock
  - Grant 152: Development Expenditure on Food and Agriculture (out of revenue account)
    - Project 143: Pakistan Cotton Research & Development Project
      - Detailed function-object

---

## **10.3 Accounting Policies**

### **10.3.1 Mode of payment**

10.3.1.1 The mode of payment for development expenditures shall be in accordance with the directions laid down in Chapter 4 of this Manual, 'Expenditures' (refer to Section 4.3). These directions require that all claims for payment be duly prepared, approved by a delegated authority, certified and authorised, before payment can be issued. For further clarification refer to Chapter 17, where payment is made through Assignment Account and Personal Ledger Accounts.

### **10.3.2 Basis of accounting**

10.3.2.1 Expenditure on development projects shall be accounted for on a cash or as committed basis, in accordance with the Manual of Accounting Principles.

### **10.3.3 Recognition of project expenditure**

10.3.3.1 Expenditure on development projects will be recognised in accordance with the Directions laid down in Chapter 4 of this Manual, 'Expenditures' (refer Section 4.3). Payments made by cheque will be recognised and recorded in the accounts of the Government on the date the cheque is issued.

10.3.3.2 All expenditures incurred under development projects included under the Schedule of Authorised Expenditure must be recorded in the Government accounting system, regardless of the source of funding. Direct funding arrangements between donors and project managers must still be recorded and reported by the Government, if the expenditure is included in the Schedule of Authorised Expenditure.

10.3.3.3 The expenditure of a development project must include all direct costs of undertaking the project. The following items are to be included in development project expenditures:

- the cost of establishment, that is, salaries and allowances of permanent and temporary staff, including that of the project manager. Where a staff member is only engaged on the project on a part-time basis, a suitable proportion of his/her time should be charged to the project
- direct purchases of materials and items of plant and equipment acquired exclusively for the project
- direct services purchased exclusively for the project such as training, casual labour and other contract work

- any direct costs incurred and passed on from other departments or governments that relate to the project, as agreed between the Principal Accounting Officers of the concerned ministries and departments
- any other costs set out in the development project budget, included as part of the Schedule of Authorised Expenditure that have been incurred

10.3.3.4 Development project expenditures should not include any indirect costs, such as interest, depreciation, or administrative overheads unless specifically provided for in the project budget.

#### **10.3.4 Commitment accounting**

10.3.4.1 Commitments shall be recorded for development projects, in accordance with the accounting policy laid down in chapter 4 of this Manual (refer Section 4.3).

#### **10.3.5 Recognition of revenue**

10.3.5.1 Amounts recovered or income generated by the Government from a development project, either during or after completion of the project, will be placed into the Federal or Provincial Consolidated Fund (as the case may be) and recorded as miscellaneous revenue. Such monies shall not be used to meet project expenditures, unless appropriated through Parliament.

---

## **10.4 Accounting for Project Expenditures**

### **10.4.1 Accounting records**

- 10.4.1.1 The books of account required to be kept by DAO/AG/AGPR offices, as specified in chapter 4 of this Manual 'Expenditures', namely the Appropriation Register, Sub-Ledger and General Ledger shall include all transaction details associated with development projects (refer Section 4.4).
- 10.4.1.2 The transactions recorded for development projects at DAO/AG/AGPR level shall be coded according to the Chart of Accounts, and provide sufficient detail to allow objectwise reporting for each development project .
- 10.4.1.3 Within the ministry or department from which the development project is managed, detailed accounting records shall be maintained of each project, as determined by the ministry or department, to meet its own internal and external reporting obligations.

### **10.4.2 Commitment accounting records**

- 10.4.2.1 A section to record commitments will be maintained within the Appropriation register as specified in Chapter 4 of this Manual 'Expenditures' (refer Section 4.4). Commitments will be recorded when the DAO/AG/AGPR receives a commitment advice note from the concerned DDO within the ministry or department.
- 10.4.2.2 Commitments will be reversed by the authorising officer once the claim voucher, relating to a previously entered commitment (as referenced on the claim) is authorised for payment.

### **10.4.3 Accounting entries**

- 10.4.3.1 The accounting entries indicated in Section 4.4.4 relating to expenditure transactions recorded in the Sub-ledger by DAO/AG/AGPR offices are applicable to development project expenditures. In accordance with the Manual of Accounting Principles and Chapter 4 of this Manual, all outstanding commitments are to be duly scrutinised by the AG/MoF and provision made in next years appropriation to allow for the reinstatement of valid commitments in the next financial year.

### **10.4.4 Reporting and consolidation of project expenditure**

- 10.4.4.1 Development project expenditure shall be posted the General Ledger to provide date-wise totals against each detailed account head.

---

10.4.4.2 In the manual accounting system the amounts posted to each development project account shall be consolidated on a monthly basis to provide summarised object-wise balances for each development grant.

10.4.4.3 The consolidated project expenditure for each month shall be incorporated into the monthly accounts prepared by the AG/AGPR. This requires the project expenditures recorded by DAOs to be reported to the AG office in a set format.

10.4.4.4 In the computerised accounting system, the summarised project expenditure information will be generated by system based reports, rather than a manual abstraction process.

#### **10.4.5 Reconciliation of project expenditure**

10.4.5.1 Expenditure against each project shall be reconciled on a monthly basis, between the project managers records and the project expenditures recorded by AG/AGPR.

10.4.5.2 Where assignment or personal ledger accounts are in operation, subsequent releases of funds will not be made until all expenditures relating to previous releases have been accounted for and reconciled with the AG/AGPR.

#### **10.4.6 Reporting of project expenditures**

10.4.6.1 The progress of each development project should be regularly monitored against budget by the project manager. The project manager is responsible for advising the Government and the sponsoring agency on the overall progress of the project and any significant deviations from the original budget and project plan.

10.4.6.2 At the end of each month, the AG/AGPR shall prepare, by the [10<sup>th</sup>] of the following month, project reports for administrative ministries and departments on each development grant and the projects under these grants. These reports shall provide monthly expenditure, year to date expenditure, project-to-date expenditure and comparison with budget under each of these headings.

10.4.6.3 The project manager shall sign off these monthly reports, as part of the monthly reconciliation of project expenditure with the AG/AGPR. The project manager will report any discrepancies in these reports to the AG/AGPR for follow up action.

10.4.6.4 The monthly project expenditures shall be consolidated to form part of the monthly accounts prepared by the AG/AGPR.

- 10.4.6.5 The project manager shall provide expenditure statements and other reports, as required by donor agencies for progress monitoring and for reimbursement and advance of funds.
- 10.4.6.6 Quarterly reports are required by the Planning Commission within 3 weeks from the close of each quarter, in the prescribed format (PC-III). This report shall also be submitted to sponsoring agencies and in the case of foreign funded projects, to EAD.
- 10.4.6.7 The status of continuing and new projects approved is maintained in the 'Public Sector Development Program', specifying estimates for the total project cost, expenditure to date and budgetary allocations for the current financial year. Each Provincial Government also produces an equivalent document.
- 10.4.6.8 Development project expenditures will be subject to the same budgetary review and re-appropriation process as other forms of expenditure. Project Managers, through their Principal Accounting Officers and Financial Advisors, will submit statements of excesses and surrenders in relation to their current projects. Development project expenditures, and the respective excess and surrendered amounts must also be included in the Annual Appropriation Accounts prepared by the AG/AGPR offices.
- 10.4.6.9 Upon completion of each development project, the project manager is required to submit a project completion report to the Planning Commission in a prescribed format, as well as to the sponsoring entity.



# 11 Accounting for Liabilities

---

## Table of Contents

<b>11.1</b>	<b>Introduction</b>	<b>11.3</b>
<b>11.2</b>	<b>General Policy</b>	<b>11.4</b>
11.2.1	Introduction	11.4
11.2.2	Definition of liabilities	11.4
<b>11.3</b>	<b>Categories of Liabilities</b>	<b>11.5</b>
11.3.1	Domestic debt	11.5
11.3.2	External debt	11.5
11.3.3	Deferred liabilities	11.6
11.3.4	Cash balance utilisation	11.6
11.3.5	Uncleared cheques	11.6
11.3.6	Employee entitlements	11.6
11.3.7	Contingent liabilities	11.6
<b>11.4</b>	<b>Accounting Policies</b>	<b>11.8</b>
11.4.1	General	11.8
11.4.2	Accounting records	11.8
11.4.3	Accounting entries	11.8
<b>11.5</b>	<b>Accounting Procedures</b>	<b>11.10</b>
11.5.1	Introduction	11.10
11.5.2	Loan receipts	11.10
11.5.3	Loan repayments	11.11
11.5.4	Deferred liabilities	11.11
11.5.5	Employee entitlements	11.13
<b>11.6</b>	<b>Reconciliation of Liability Records</b>	<b>11.14</b>
<b>11.7</b>	<b>Reporting of Liabilities</b>	<b>11.15</b>
11.7.1	Annual Accounts	11.15

**11.1 Introduction**

- 11.1.1.1 This chapter covers the accounting and financial reporting requirements applicable to public debt and other liabilities incurred by the Government.
- 11.1.1.2 This chapter does not include detailed procedures for the management of public debt and other liabilities as they are covered by specific rules and procedures determined by Finance Division/Economic Affairs Division.
- 11.1.1.3 This chapter does not specifically deal with the accounting for foreign grants, as they are not liabilities.

## **11.2 General Policy**

### **11.2.1 Introduction**

11.2.1.1 The major categories of liabilities covered in this chapter are:

- domestic debt
- external debt
- deferred liabilities
- employee entitlements.

11.2.1.2 The payment procedures for GP fund and other payments that are associated with liabilities are covered in Chapter 4 of this Manual, 'Expenditures'.

11.2.1.3 The accounting treatment for commitments, which also represent liabilities, are covered in Chapter 4 of this Manual 'Expenditures'.

### **11.2.2 Definition of liabilities**

11.2.2.1 In accordance with the Manual of Accounting Principles, liabilities are defined as 'future sacrifices of economic benefits that an entity is presently obliged to make as a result of past transactions or other past events'.

11.2.2.2 Also in accordance with the Manual of Accounting Principles, a liability will be recognised when

- it is probable that the future sacrifice of economic benefits will be required
- the amount of the liability can be measured reliably.

### 11.3 Categories of Liabilities

#### 11.3.1 Domestic debt

11.3.1.1 Domestic debt is debt raised by the Government within Pakistan, through forms of permanent and floating debt:

- **Permanent debt** - debt raised through the issue of Government Bonds and raising of loans at fixed rates of interest and fixed maturity terms.
- **Floating debt** - debt raised through the issue of Treasury Notes and Treasury Bills for Ways and Means at variable market rates and variable maturity terms. This includes Opened Market Operations by the SBP and short-term finance provided by State Bank of Pakistan (eg. purchase of 6 month Treasury Bills).
- **Institutional debt** – debt raised from various financial institutions at various fixed and floating rates of interest.

11.3.1.2 Domestic debt is managed by Ministry of Finance. The procedures for domestic loans are regulated by the Public Debt Act (1944) with supplementary procedures set out in the Government Securities Manual.

#### 11.3.2 External debt

11.3.2.1 External debt is finance obtained from abroad, in the form of long term, medium term, and short term debt. The Federal and Provincial Governments obtain loans (and grants) from foreign donor agencies, such as foreign banks and organisations, as well as foreign Governments. External loans may be obtained for particular development projects (project assistance) or be provided for general budgetary support (non-project assistance).

11.3.2.2 External debt is managed by the Economic Affairs Division. Detailed rules and regulations issued by MoF, governing the administration of foreign loans shall be followed.

11.3.2.3 External debt should be distinguished from grants received from overseas donors. Such foreign assisted grants are not liabilities.

11.3.2.4 Where external loans are provided in the form of commodities, such as supplies, equipment and food, the liability shall be recorded at the cash (Rupee) equivalent.

---

### 11.3.3 Deferred liabilities

- 11.3.3.1 These are liabilities which arise when monies raised from various savings schemes and funds launched by the Government are utilised in operations. These liabilities are 'deferred' in the sense that they will be funded by future revenues of the Government, and repaid upon expiry of the relevant scheme or fund. Deferred liabilities include Savings and Deposits Certificates, Savings Bank Accounts and Provident Funds.
- 11.3.3.2 These liabilities shall be recorded on the Liabilities Register and form part of the budgeting process in the subsequent years as stated in section 3.3.5 of Chapter 3 – Budgetary Control of this Manual.
- 11.3.3.3 Any initiatives launched by the Government that do not require repayment (eg. certain classes of debt retirement scheme) are not considered liabilities, and shall not be recorded as such.

### 11.3.4 Cash balance utilisation

- 11.3.4.1 Further to domestic and external borrowings and the use of deferred liabilities, the Government may obtain additional short-term finance from the State Bank of Pakistan to fund the overall fiscal deficit, if it arises. This is referred to as 'Cash Balance Utilisation'.

### 11.3.5 Uncleared cheques

- 11.3.5.1 The balance contained in the cheque clearing account, representing cheques issued by the DAO/AG/AGPR, self-accounting entities and project directors, but not yet cleared by the bank.

### 11.3.6 Employee entitlements

- 11.3.6.1 The following are classes of liability that exist in relation to employee entitlements. The recognition of such liabilities in the accounts shall be determined, in light of the recognition criteria set out in the Manual of Accounting Principles, by the Auditor-General.
- **Pension** - the liability arising from a Government employee's entitlement to a stream of payments after they retire from service. Such liability shall be subject to periodic review by a professional actuaries and updated by actuaries estimates.
  - **Encashment of Leave** - liability arising from entitlements to the various forms of leave earned by Government employees.

### 11.3.7 Contingent liabilities

- 11.3.7.1 In certain cases, amounts may be borrowed by public enterprises, provinces and autonomous agencies on the guarantee of the Federal

Government or its agencies. These are not liabilities because there is no present obligation for the Government to pay the loan, unless the loan defaults. Such guarantees are referred to as 'contingent liabilities' and will be disclosed in notes to the financial statements. If the loan under guarantee does default, then a liability will be recognised to the extent that the guarantee is expected to be fulfilled.

- 11.3.7.2 Contingent liabilities, where identified, shall be recorded in the Liabilities Register.

## **11.4 Accounting Policies**

### **11.4.1 General**

- 11.4.1.1 All loan monies received must be recorded as a capital receipt in the Federal or Provincial Consolidated Fund. This includes any direct loans from donors to beneficiaries within the Government.
- 11.4.1.2 The debt servicing cost (i.e. interest) and loan repayments must both be treated as charged items under the Federal or Provincial Consolidated Fund, and recognised in the accounts when paid.
- 11.4.1.3 In certain cases foreign loans obtained by the Government are re-lent to autonomous bodies and agencies, at a rate different from that on which the original loan was obtained. The difference in interest earned and interest paid in this case shall be retained in a separate head and treated as income or expense of the Government.

### **11.4.2 Accounting records**

- 11.4.2.1 Cash transactions arising from liabilities (eg. loan receipts, repayments of interest and principal) shall be recorded in the Sub-Ledger and General Ledger of the respective DAO/AG/AGPR offices.
- 11.4.2.2 The related non-cash transactions arising from liabilities (eg. loan liability, loss or gain on exchange), shall also be recorded for incorporation into the Annual Accounts. Where any non-cash transactions are recorded in the liability records, a corresponding direct adjustment to equity shall be made, rather than to expenditures or receipts. A non-cash transactions is a financial transaction which do not involve a cash movement but can effect the outstanding liability e.g. loss or gain on foreign exchange can change the liability amount without any movement of cash.
- 11.4.2.3 The detail of all liabilities recognised shall be held in a Liabilities Register by the AGPR and AG offices, and periodically updated as advised from the appropriate entities. This Register shall hold a formal detailed and aggregated record of all recognised liabilities for the respective Federal or Provincial Governments.

### **11.4.3 Accounting entries**

- 11.4.3.1 The following accounting entries are applicable to transactions involving liabilities. These entries shall be made in the Sub-ledger at a transaction level, and subsequently transferred into the General Ledger.



11.4.3.2 The accounting entry posted , upon receipt of loan monies is:

Dr	Bank Account
Cr	Capital Receipts - loans

[recording of loan monies received]

11.4.3.3 Also upon receipt of loan money, the liability record shall be updated and supporting details recorded in the Liabilities Register.

11.4.3.4 Repayments of principal and interest shall be accounted for under separate heads of account in the Chart of Accounts. The accounting entries required are as follows:

Dr	Interest Expenditure and/or
Dr	Loan Principal Repayments
Cr	Bank Account

[to record the repayment of principal and interest on loans]

11.4.3.5 Also upon repayment of the loan, the liability record shall be updated and supporting details recorded in the Liabilities Register.

11.4.3.6 Where the Government receives loan monies on behalf of other bodies, the loan receipt should be recorded in the Public Account against an appropriate head, from which the loan monies will be transferred. The required accounting entries are as follows:

Dr	Bank Account
Cr	Loans received (Public Account)

[to record the receipt of loan monies by the Government, on behalf of other bodies]

Dr	Loans received (Public Account)
Cr	Bank Account

[to record the transfer of loan monies by the Government, to recipient bodies]

## **11.5 Accounting Procedures**

### **11.5.1 Introduction**

11.5.1.1 The following accounting procedures covers the treatment of loans and other liabilities.

11.5.1.2 The following key controls shall be observed when processing receipts and repayments of loans:

- cash transactions arising from loans should be identified against the proper receipt and payments heads, giving reference to the concerned Federal or Provincial Government
- reconciliation of loan liability records of AG/AGPR with EAD/MoF, in relation to domestic and external debt
- reconciliation of loan receipts and repayment transactions between AGPR/AG and EAD/MoF records
- reconciliation of loan liability records of AG/AGPR with other concerned ministries and departments in relation to recognised liabilities.

### **11.5.2 Loan receipts**

11.5.2.1 Loan monies may be received from lending agencies in the form of an advance (eg. mobilisation advance) or reimbursement of expenditure previously incurred by the beneficiary. In the case of external loans, the funds are received initially by the National Bank of Pakistan branch in New York, who then place the funds (through the NBP-HQ Karachi) into the relevant bank accounts of the Government, including assignment accounts where applicable. These balances shall be reported to the SBP-HQ on a daily basis.

11.5.2.2 SBP-HQ shall advise both AG/AGPR and EAD/MoF, by daily bank scroll, of the loans received from lending agencies. EAD/MoF shall also seek independent confirmation from the lending agency of the funds deposited.

11.5.2.3 EAD/MoF/FD shall then provide AG/AGPR with the required accounting details relating to the loan receipt (amount, date received, receipt head to be charged etc.). Upon receipt of this advice, AG/AGPR shall make the Sub-ledger accounting entry specified in Direction 11.4.3.2, to record the capital receipt and increase in cash, and at the same time update the liability record/Liabilities Register in accordance with Direction 11.4.3.3.

---

### 11.5.3 Loan repayments

- 11.5.3.1 The scheduling of loan repayments is undertaken by EAD (in relation to external loans) and MoF (in relation to domestic loans), in accordance with the schedules provided in loan agreements. When a repayment needs to be made, EAD/MoF shall authorise the State Bank of Pakistan to make the repayment, informing them of the relevant details.
- 11.5.3.2 Prior to authorisation, EAD/MoF will conduct a certification exercise, to ensure the accuracy of the following:
- repayment schedules of the loan agreement
  - amount (principal and interest)
  - payment of related fees and charges
  - currency
  - demand notice from the lender
  - account heads to be used (principal, interest, related expenses), and check against available budget (i.e. debt servicing budget)
- 11.5.3.3 If, for any reason, the above checks are not satisfied, then the repayment authority shall not be given to SBP, and instead be referred back the relevant authority in EAD/MoF.
- 11.5.3.4 Immediately after a loan repayment is made, SBP shall inform EAD/MoF of the repayment, with a copy to AGPR (or in the case of a Provincial Government, the relevant AG office). All relevant details of the repayment should be included in this advice, including loan identifier, relevant account heads, date of repayment and interest and principal components of the repayment, in Rupees, as well as the relevant foreign currency.
- 11.5.3.5 AGPR/AG shall then make the Sub-ledger accounting entry specified in Direction 11.4.3.4 to record the loan principal and interest repayments, and at the same time update the liability record/Liabilities Register in accordance with Direction 11.4.3.5 of this chapter.

### 11.5.4 Deferred liabilities

- 11.5.4.1 This section briefly outlines the accounting procedure to be followed in relation to the recording of deferred liabilities. Specific procedures for each scheme or provident fund, as issued by the Government, shall be followed in all cases. This subject is also covered in Chapter 14 of this Manual, 'Public Account Transactions'.

11.5.4.2 The receipt of funds in regard to the various savings and deposits schemes operated by the Government is undertaken by designated banks, savings centres and post offices. These collections are reported to the National and State Bank who then produce daily scrolls of receipts in accordance with Chapter 5 of this Manual, 'Receipts'.

11.5.4.3 When funds are received on account of various deposit and savings schemes, the transaction shall be recorded in the Sub-Ledger/General Ledger of the AG/AGPR/DAO against the appropriate head within the Public Account:

Dr	Bank Account (Public Account)
Cr	Relevant Public Account head*

[\*such as Savings Bank Deposits, Federal Savings Certificates, Federal Deposits Certificates and National Savings and Deposits Certificates]

11.5.4.4 At the same time as recording the receipt transaction, the AG/AGPR shall update the liability records/Register maintained in that office. In the case of DAOs, their monthly account of receipts against these Public Account Heads shall be reported to the AG/AGPR who shall then update their liability records/Liability Register accordingly.

11.5.4.5 Where the Government makes use of these funds held in the deferred liability accounts, a receivable entry will be made in the Public Account. Refer to Chapter 14 of this Manual 'Public Account Transactions' for details of these entries.

11.5.4.6 Funds held in savings and deposit schemes shall be repaid when an investor submits their certificate for encashment to the designated bank, savings centre or post office, subject to the terms and conditions of the individual scheme and procedures undertaken by these offices. All payments from the schemes shall be reported to the relevant AG/AGPR office.

11.5.4.7 Upon repayment of funds from a savings or deposit scheme to its investors, the following accounting transaction shall be recorded in the Sub-Ledger/General Ledger:

Dr	Relevant Public Account Head
Cr	Bank Account (Public Account)

11.5.4.8 At the same time as recording the payment, the AG/AGPR shall update the liability record to reflect the reduction in liability from the scheme, and also update the details of the Liabilities Register.

**11.5.5 Employee entitlements**

- 11.5.5.1 In accordance with the policy laid down in Section 11.3.6 of this chapter, employee entitlements shall be recognised as liabilities when the recognition criteria (indicated in Direction 11.2.2.2) have been met.
- 11.5.5.2 These liabilities may not necessarily arise from a cash transaction. For example, a periodic actuarial estimate of pension liability may be considered more cost-effective than maintaining a detailed recording process. The method of liability estimation in these cases will be determined by the Auditor-General, in consultation with the MoF.
- 11.5.5.3 Where such liabilities are recognised, they will be raised by AG/AGPR in the liability records included in the Liability Register and updated on an annual basis.
- 11.5.5.4 Contributions into and payments from the General Provident and other provident funds will be recorded as transactions in the relevant heads of the Public Account. The procedures for such entries are covered in Chapter 4 of this Manual, 'Expenditures'.
- 11.5.5.5 Payments of pension are made from the Federal or Provincial Consolidated Fund, in accordance with the procedure laid down in Chapter 4 of this Manual, 'Expenditures'.
- 11.5.5.6 Periodic adjustments in the liability records will be made prior to the end of the financial year, to bring the liability balances up to date.

**11.6 Reconciliation of Liability Records**

- 11.6.1.1 On a monthly basis, AGPR/AG shall reconcile the balances of external and domestic debt held in its liability records/registers to the monthly report provided by EAD, in accordance with the reporting requirements identified in Direction 11.7.1.2.
- 11.6.1.2 The reconciliation between AG/AGPR and EAD/MoF balances shall identify any gains and losses arising from foreign currency loans. A record of such foreign exchange gains and losses shall be kept by AG/AGPR by adjusting (increasing for a loss, decreasing for a gain) the liability record and making a corresponding adjustment to equity. The losses and gains identified during reconciliation shall be agreed with EAD/MoF at the end of each financial year.
- 11.6.1.3 Also, on a monthly basis the balances contained in the accounts of receipts and payments in respect of loans and other liabilities shall be reconciled by AG/AGPR to the movement in the liability records/registers maintained by these offices.
- 11.6.1.4 On a monthly basis, EAD/MoF shall reconcile:
- the sum of all domestic and foreign loan receipts advised by SBP, to the accounts of loan receipts as recorded by AG/AGPR
  - the sum of all authorised loan repayments confirmed by SBP to the accounts of loan repayments (interest and principal)

## **11.7 Reporting of Liabilities**

### **11.7.1 Annual Accounts**

11.7.1.1 Balances of liabilities, in their various forms, will be reported in the quarterly, six monthly and annual accounts. In accordance with the Financial Reporting Manual, the classes of liability to be recognised shall include:

- public debt
- deferred liabilities
- other classes of liability, as approved for recognition by the Auditor-General

11.7.1.2 To support the above disclosures, EAD/MoF shall prepare on a monthly basis, a Debt Report (see 1.3 and 1.3a of MERR) containing balances of the various classes of public debt, and movements in those balances. This report shall be produced in accordance with the format laid down in the Manual of External Reporting Requirements.

11.7.1.3 AG/AGPR shall then verify the information submitted in the Credit Report to their own liability records and registers, before incorporating into the Consolidated Monthly Accounts. The AG/AGPR shall investigate and agree with the EAD/MoF any differences which may arise during their verification of the Credit Report.

11.7.1.4 AG/AGPR shall also incorporate the balances of other liabilities (including current and deferred liabilities) into the Consolidated Monthly Accounts.

11.7.1.5 EAD/MoF shall also obtain monthly reports from project authorities (project directors and controlling ministries), providing detail on the receipt and utilisation of external and domestic loans. EAD/MoF shall watch for the correct utilisation of funds, and identify any funding received outside of the NBP/SBP process.

# **12 Transactions Between Government Entities**



---

## Table of Contents

<b>12.1</b>	<b>Introduction</b>	<b>12.3</b>
12.1.1	Overview	12.3
12.1.2	Definition of transaction between the Government entities	12.3
12.1.3	Types of transaction between the Government entities	12.3
12.1.4	Types of government entities involved in the transactions	12.4
<b>12.2</b>	<b>General Policies</b>	<b>12.5</b>
12.2.1	Overview of types of inter-entity transactions and processes	12.5
12.2.2	Purchase of goods/services by one Government entity acting as an agent for another Government entity.	12.6
12.2.3	Provision of services by one government entity to another government entity	12.7
12.2.4	Responsibilities	12.7
12.2.5	Mode of payment	12.8
<b>12.3</b>	<b>Accounting Policies</b>	<b>12.9</b>
12.3.1	Recognition of inter-entity receipts	12.9
12.3.2	Recognition of inter-entity expenditure	12.9
12.3.3	Exchange accounts	12.9
12.3.4	Settlement accounts	12.9
12.3.5	Transactions with foreign Governments	12.11
12.3.6	Transactions between government entities and government commercial undertakings	12.11
12.3.7	Consolidation of inter-entity transactions	12.11
<b>12.4</b>	<b>Accounting for transactions between Government entities</b>	<b>12.12</b>
12.4.1	Manual accounting records	12.12
12.4.2	Computerised accounting records	12.12
12.4.3	Accounting entries for transactions between government entities	12.12
12.4.4	Transaction between a government entity and a commercial entity	12.14
<b>12.5</b>	<b>Detailed Procedures</b>	<b>12.15</b>
12.5.1	Introduction	12.15
12.5.2	Budgetary control procedures	12.15
12.5.3	Expenditure processing and recording	12.16
12.5.4	Approval of inter-entity transactions	12.17
12.5.5	Recording of inter-entity transactions in the office of DAO/AG/AGPR	12.19
12.5.6	Inter-entity transfer of funds	12.21
12.5.7	Consolidation of inter-entity transactions	12.22
12.5.8	Reporting of inter-entity transactions	12.22
12.5.9	Reconciliation of inter-entity balances	12.23

## **Introduction**

### **12.1.1 Overview**

- 12.1.1.1 This chapter deals with the policies, accounting treatment and procedures for transactions between the Government entities.
- 12.1.1.2 The policies include both general and accounting policies for transactions between the Government entities. The general policies give guidance on how particular inter-entity transactions should be handled. It also indicates the responsibilities of the supplying and receiving entities. The accounting policies deal with the recognition and consolidation of transactions between the Government entities using exchange and settlement accounts.
- 12.1.1.3 The accounting treatment details the records which need to be maintained for complete and accurate recording of transactions between the Government entities and the appropriate double entries for recording the transactions in the general ledger.
- 12.1.1.4 The procedures cover the approval, recording, transfer of funds, consolidation, reporting and reconciliation of transactions. Additionally there are further procedures for specific classes of transaction.

### **12.1.2 Definition of transaction between the Government entities**

- 12.1.2.1 A transaction between the Government entities is where a transaction originates in one Government entity but is subsequently transferred to another Government entity. The exact circumstances in which this occurs are detailed in Section 12.2 'General Policies'.

### **12.1.3 Types of transaction between the Government entities**

- 12.1.3.1 The two principal types of transaction between Government entities are:
- purchase of goods/services or receipt of income by one government entity acting as an agent for another government entity (the principal entity), for example the central stores facility
  - provision of services by one government entity to another government entity. For example the PWD providing a service to a spending department. This may include the purchase of goods/supplies on an agent basis as above.
- 12.1.3.2 The provision of services is subdivided further into services for which:
- charges should not be made

- charges should be made.

#### **12.1.4 Types of government entities involved in the transactions**

12.1.4.1 The two principal types of transaction are between:

- departments in the same Government (inter-department)
- Governments (inter-Government), who maintain separate accounting records and bank accounts.

12.1.4.2 The inter-department transaction is subdivided further into:

- transactions between departments centrally accounted for by the Government, maintaining the same bank account (generally Non-Food)
- transactions involving self-accounting entities, who maintain their own accounting records, but who submit their accounts to the Accountant General's office each month to be consolidated with the central records. These generally maintain the same bank account (Non-Food) with the State Bank but may have separate bank accounts
- transaction involving ministries outside the Pakistan Audit Department system who maintain separate accounting records and bank accounts (Railways).

12.1.4.3 The entity in which the transaction initially occurs is termed the originating entity, this will be the entity acting as agent/supplier.

12.1.4.4 The entity to which the transaction is transferred is termed the principal or receiving entity.

**12.2 General Policies**

**12.2.1 Overview of types of inter-entity transactions and processes**

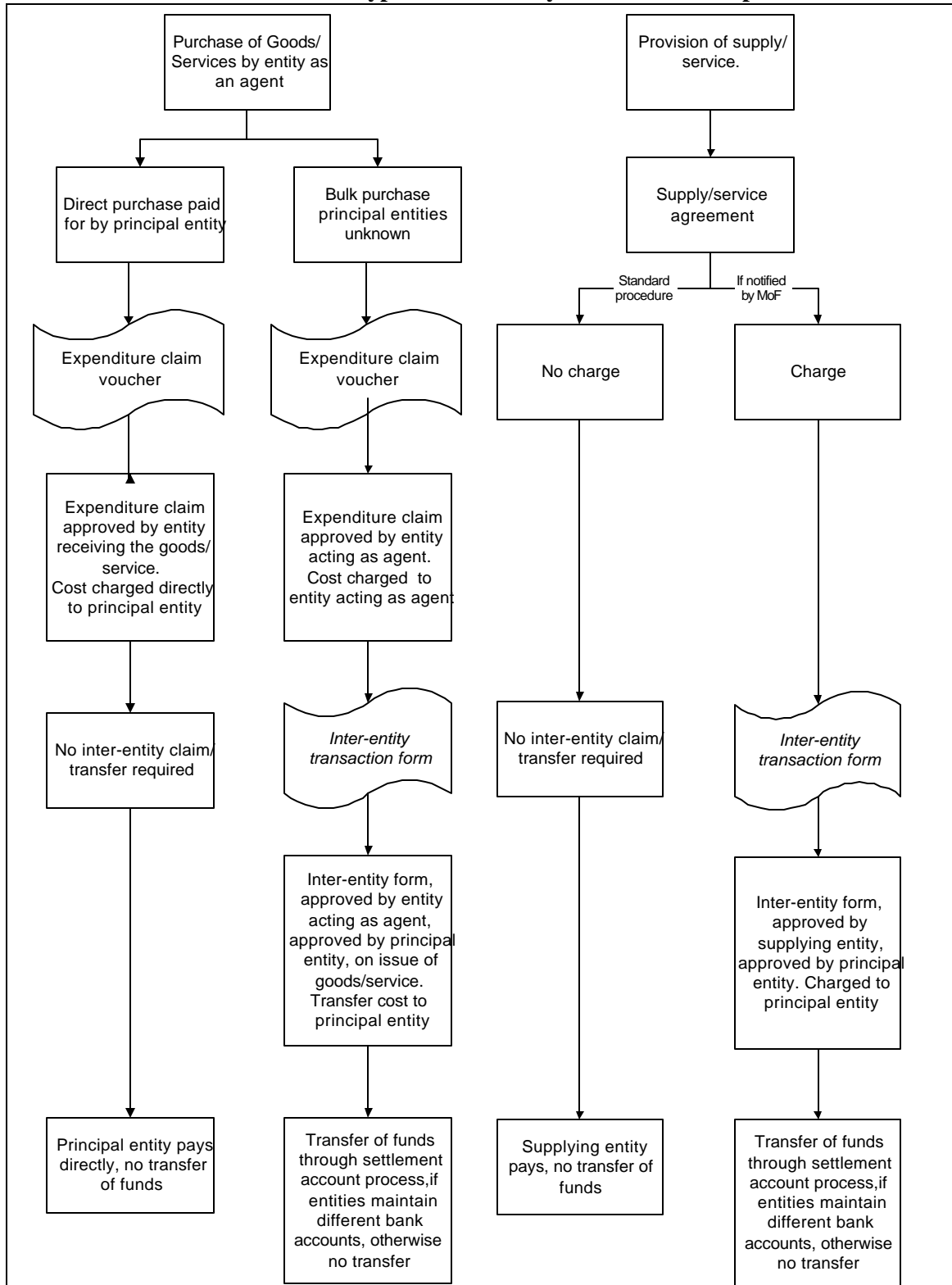

---

**12.2.2 Purchase of goods/services by one Government entity acting as an agent for another Government entity.**

12.2.2.1 The two principal types of purchase on behalf of another entity are:

- specific purchase of a good/service for a known principal entity/entities
- general purchase of a good/service where the principal entity/entities is unknown.

12.2.2.2 Where a specific purchase is made and paid for by the principal entity this should be regarded as a direct purchase by the principal entity which will benefit from the good/service and the following policies applied:

- the policies and procedures relating to the purchase detailed in Chapter 4 'Expenditures' must be applied
- the expenditure must be charged directly to the principal entity benefiting from the purchase
- approval must be immediately obtained from the delegated officer within the principal entity benefiting from the purchase and not the entity acting as agent
- consequently, no inter-entity transaction is required, as the entity incurring the expense is the one receiving the benefit.

12.2.2.3 Where a general purchase is made and paid for by the agent this should initially be regarded as an expense to the agent entity making the purchase. Subsequently when an issue is made, the appropriate proportion relating to any issues must be transferred to the principal entity ultimately receiving the goods/services. When an issue is made and the following policies applied:

- the policies and procedures relating to the purchase detailed in Chapter 4 'Expenditures' must be applied
- the expenditure must initially be charged to the originating entity acting as agent
- approval must initially be obtained from the entity making the original purchase and subsequently from the principal entity obtaining the ultimate benefit
- subsequently the appropriate proportion of this expenditure must be transferred to the principal entity to whom the purchase issue is made
- consequently, an inter-entity transaction will be required, to transfer the expense from the original purchaser to the beneficiary.

12.2.2.4 The general policies are applied to purchases. Similar general policies must be applied to receipts, but in accordance with Chapter 5 'Receipts' rather than Chapter 4 'Expenditures'.

### **12.2.3 Provision of services by one government entity to another government entity**

12.2.3.1 Provision of supply/service should be set down in a supply/service agreement between the entities.

12.2.3.2 A government entity shall not charge another government entity for services, unless directed by the Ministry of Finance and provided by a supply/service agreement. Consequently the costs will remain with the entity making the supply and an inter-entity transaction will not be required.

### **12.2.4 Responsibilities**

12.2.4.1 The supplying and receiving entities must have clear and defined roles and responsibilities, for example in supply and service agreements.

12.2.4.2 The supplying and receiving entity must each be responsible for their own actions, whether an inter-entity transaction is required or not. For example, although no inter-entity transaction will be required where a service is provided, the receiving entity must still be responsible for the part that it plays including in the specification, acquisition and consumption of goods/services.

12.2.4.3 In general the distinction between supplying and receiving entity responsibilities should be that:

- the receiving entity should be responsible for the requirement (volume/standards of service) and the use to which the goods/services are put
- the supplying entity should be responsible for the efficiency, economy and effectiveness with which it meets the receiving entity's requirement and will be held responsible for any waste resulting from deficiencies in its own operations, unless otherwise specified in the supply/service agreement (Direction 12.2.4.4).

In practice the distinction will depend on the unique circumstances of the agreement between the two entities

12.2.4.4 The supply and service agreement shall specify whether the supplying or receiving entity is responsible for losses or rectifying mistakes.

12.2.4.5 Where an inter-entity transaction is not required and the receiving entity immediately records the expenditure:

- the supplying entity must still be responsible for the part it plays in providing the goods/services, as detailed in Direction 12.2.4.3. This must include the approval of invoice claims where, acting as an agent, it is in a more appropriate position to perform this role than the ultimate receiving entity
- the receiving entity should not incur further costs by duplicating these checks, but should ensure that these checks have been satisfactorily performed before approving the claim.

12.2.4.6 Where the ultimate recipient of a good/service is unknown or where the cost will be transferred later via an inter-entity transaction:

- the approval of claims must be performed by the originating entity acting as agent
- subsequently the supplying entity, as the entity in which the transaction originated shall issue an approved inter-entity transaction claim form [Form 12A] for authorisation by the receiving entity
- the supplying entity should submit any relevant invoice claims with the inter-entity claim forms as supporting documents, if requested by the receiving entity.

12.2.4.7 Where a transfer of funds is required, the entity making the payment must issue a notification to the SBP via the Accountant General's office to initiate the transfer and inform the entity receiving the funds of the transfer.

### **12.2.5 Mode of payment**

12.2.5.1 The nature of settlement required depends on the status of the entities involved in the transaction, as detailed above in Section 12.1.4.

12.2.5.2 Inter-department transactions, where the departments share the same bank accounts, require no transfer of funds.

12.2.5.3 Inter-department transactions, where the departments do not share the same bank account, require transfer of funds.

12.2.5.4 Inter-Government transactions, as they do not share the same bank accounts, require transfer of funds through the settlement process. However below a threshold set by the Comptroller General the transfer of cash may be more effectively performed through the issue of a cheque by the entity making the payment.

## **12.3 Accounting Policies**

### **12.3.1 Recognition of inter-entity receipts**

12.3.1.1 The majority of receipts arising from inter-entity transactions, are recoveries of expenditure already incurred and therefore shall be recognised, in the accounts of the charging entity, as such and not as income. Receipts which are income should be recognised as such in accordance with Chapter 5 'Receipts'.

12.3.1.2 Recognition of the expenditure recovery arising from an inter-entity transaction must occur in the accounts of the charging entity on the date that the cash transfer is made by the transferor (Direction 12.4.3.2).

### **12.3.2 Recognition of inter-entity expenditure**

12.3.2.1 Recognition of expenditure incurred directly by a government entity shall be consistent with Chapter 4 'Expenditures'.

12.3.2.2 Recognition of expenditure incurred by a government entity acting as an agent, where the principal entity is unknown, shall be consistent with Chapter 4 'Expenditures'.

12.3.2.3 Recognition of expenditure arising from an inter-entity transaction shall occur in the accounts of the entity being charged on the date that the cash transfer is made by the transferor (Direction 12.4.3.2).

### **12.3.3 Exchange accounts**

12.3.3.1 All inter-entity transactions within the same government involving self-accounting entities and entities outside the control of the Accountant General's offices must be accounted for using the exchange account process and therefore any transfers must be reflected in both sets of accounts (ie the government and the entity) This is described in detail in the Accounting Treatment section of this Chapter (Section 12.4).

12.3.3.2 The permissible exchange accounts shall be detailed in the Chart of Accounts. Exchange accounts used should conform with those detailed in the Chart of Accounts.

### **12.3.4 Settlement accounts**

12.3.4.1 All inter-entity transactions between governments must be accounted for using the settlement account process. This is described in detail in the Accounting Treatment section of this Chapter (Section 12.4).

---



12.3.4.2 Settlement accounts will arise as a result of:

- amounts receivable/payable to another government brought through book adjustments
- Federal/Provincial receipts and payments at Provincial/ Federal account offices
- receipts/payments relating to Departmental Officers from other governments
- misclassifications which subsequently require adjustment through the Settlement account process.

12.3.4.3 An example of a misclassification adjustment would be Federal receipts which are misclassified in the Provinces. These should not normally be processed using settlement accounts. This is because the receipts should be banked into the appropriate Federal Government bank account at the point of collection. This information is then submitted to the relevant AGPR sub-office. However, where a receipt is collected and incorrectly posted to the Provincial account and then is adjusted to the Federal accounts (or vice-versa), the settlement account process will be required.

12.3.4.4 All inter-entity transactions between governments shall be processed using settlement accounts apart from:

- allocation from the general divisible pool of resources by the Federal Government to the Provinces (share of Federal taxes)
- grants paid to the Provinces by the Federal Government
- repayments of principal and interest by the Provinces for loans provided by the Federal Government.

12.3.4.5 Adjustments involving the settlement account process and the transfer of cash should be reflected in the accounts of both entities on a monthly basis.

12.3.4.6 Settlement account transactions relating to a financial year must be notified to the State Bank by 15<sup>th</sup> July of the following year. [Any transactions received by SBP after this date will remain in the relevant suspense accounts until clearance in the following financial year.]

12.3.4.7 The permissible settlement accounts shall be detailed in the Chart of Accounts. Settlement accounts used should conform with those detailed in the Chart of Accounts.

**12.3.5 Transactions with foreign Governments**

12.3.5.1 All amounts due for payment or receipt on behalf of foreign Governments and other States must initially be recorded in the accounts of the Federal Government under the head 'Accounts with foreign Governments', pending recovery from or payment to those governments. Subsequently, if appropriate, an adjustment between the Federal and Provincial Governments should be made.

**12.3.6 Transactions between government entities and government commercial undertakings**

12.3.6.1 A government entity must charge and be charged for goods/services provided to/by government owned commercial undertakings and autonomous bodies. Such transactions should be considered the same, in principle, to any arms length transaction between government entities and private sector bodies.

**12.3.7 Consolidation of inter-entity transactions**

12.3.7.1 Inter-entity account balances within the same government shall be recognised in the accounts of the individual entity, but cancelled out on consolidation. Consequently the balances should not be recognised in the Consolidated Monthly Accounts.

12.3.7.2 Inter-entity account balances between governments shall be recognised in the separate accounts of each government, but cancelled out on consolidation in the Federal and Provisional Government's accounts.

## 12.4 Accounting for transactions between Government entities

### 12.4.1 Manual accounting records

12.4.1.1 Manual accounting records must be maintained for expenditure and receipts as detailed in Chapters 4 and 5 of this manual.

### 12.4.2 Computerised accounting records

12.4.2.1 The computerised system will operate for inter-entity transactions for expenditures and receipts as detailed in the appropriate Chapters 4 and 5 of this manual.

### 12.4.3 Accounting entries for transactions between government entities

12.4.3.1 Where a transaction between government entities needs to be recorded, as defined in the policy section (Section 12.2), the appropriate double entry is dependant on the type of entities involved, as defined in the introduction to this Chapter (Section 12.1).

#### 12.4.3.2 Inter-Government transactions

*Example:* The Federal Government incurs an expenditure and charges for issues supplied to a provincial government (Direction 12.1.4.1).

- recognition of incurring the expenditure

Federal accounts

Dr		Federal/Provincial settlement account
	Cr	Cheque clearing account

- recognition of inter-entity transfer, when transaction is passed from AGPR to the Provincial AG.

Provincial accounts

Dr		Expense head account
	Cr	Federal/Provincial settlement account

- Recognition of transfer of the cash between bank accounts, from Provincial AG to Federal AG, on receipt of clearance memo from bank.

Federal accounts

Dr		Bank account
	Cr	Federal/Provincial settlement account

Provincial accounts

Dr		Federal/Provincial settlement account
	Cr	Bank account

### 12.4.3.3 Inter-department transactions

a) Transaction between departments centrally accounted for by the Government (Direction 12.1.4.2)

*Example:* Department A initially incurs an expense on behalf of Department B

- recognition of inter-department transfer

Dr		Department B Expenditure Head
	Cr	Department A Expenditure Head

b) Additionally where the departments do not share the same bank account the department making the cash transfer shall notify the SBP of the transfer (Direction 12.1.4.2).

c) Transaction between departments accounted for involving self-accounting entities, not requiring a transfer of funds (Direction 12.1.4.2).

*Example:* Department X provides supplies/services to the Department Y.

- Recognition of incurring the expenditure

Department X's accounts

Dr		Dept X/Dept Y exchange account
	Cr	Cheque clearing account

X sends the voucher to Department Y, Department Y will either accept or reject the transfer. Upon acceptance, and exchange of vouchers, the journal entry is:

- Recognition of inter-entity transfer

Department Y's accounts

Dr		Expenditure
	Cr	Dept Y/Dept X exchange account

d) Additionally where the departments do not share the same bank account the department making the cash transfer shall notify the SBP of the transfer (Direction 12.1.4.2).

At the end of the month, the monthly civil accounts must net out the exchange account. This exchange process may be carried out on a monthly basis, and not necessarily on an individual transaction basis.

- Recognition of transfer of the cash between bank accounts, from Department Y to Department X on receipt of clearance memo from bank.

Department X accounts

Dr		Bank Account
	Cr	Dept X/Dept Y exchange account

Department Y accounts

Dr		Department Y/ X exchange account
	Cr	Bank Account

#### **12.4.4 Transaction between a government entity and a commercial entity**

Double entry in accordance with Chapter 4 'Expenditures' and Chapter 5 'Receipts'

## **12.5 Detailed Procedures**

### **12.5.1 Introduction**

- 12.5.1.1 This section describes the procedures and key controls to be performed for inter-entity transactions.
- 12.5.1.2 The processing of inter-entity transactions must comply with the directions laid down in previous sections of this Chapter.
- 12.5.1.3 The procedures apply to those situations detailed in the General Policy section and highlighted in the overview (Section 12.2.1) which give rise to inter-entity transactions being required.
- 12.5.1.4 The following key internal controls must be observed for inter-entity transactions:
- all expenditure claim vouchers shall be approved
  - no charges shall be made for services between Government entities unless instructed by the Ministry of Finance
  - all inter-entity transactions must be supported by inter-entity transfer forms, prepared and approved by the entity making the charge and approved by the receiving entity
  - all inter-entity transfers of cash above a monetary threshold must be performed through the settlement account process and a regular bank reconciliation must be undertaken to include these transfers (Chapter 6)
  - monthly financial reports must be produced and monitored by a delegated authority detailing inter-entity transactions (Chapter 7)
  - the Accountant General's offices must perform monthly consolidation of division/department accounts in which inter-entity balances must be reconciled and exchange and settlement account balances cleared.

### **12.5.2 Budgetary control procedures**

- 12.5.2.1 The principal entity must ensure that the funds are available for the inter-entity transaction.
- 12.5.2.2 Any supplying entity required to undertake work or incur expenditure on behalf of another is required to exercise proper budgetary control over funds provided by the principal authority as detailed in Chapter 3 'Budgetary Control' and in the responsibilities section of this chapter (Direction 12.2.4).

12.5.2.3 The supplying entity must ensure that:

- the funds provided by the principal entity are not exceeded
- the money is spent for the intended purpose
- any anticipated savings are promptly surrendered back to the principal entity, unless agreed otherwise.

### **12.5.3 Expenditure processing and recording**

12.5.3.1 The procedure for processing and recording of expenditure claim vouchers shall be in accordance with Chapter 4 'Expenditures'.

**12.5.4 Approval of inter-entity transactions**

12.5.4.1 Overview

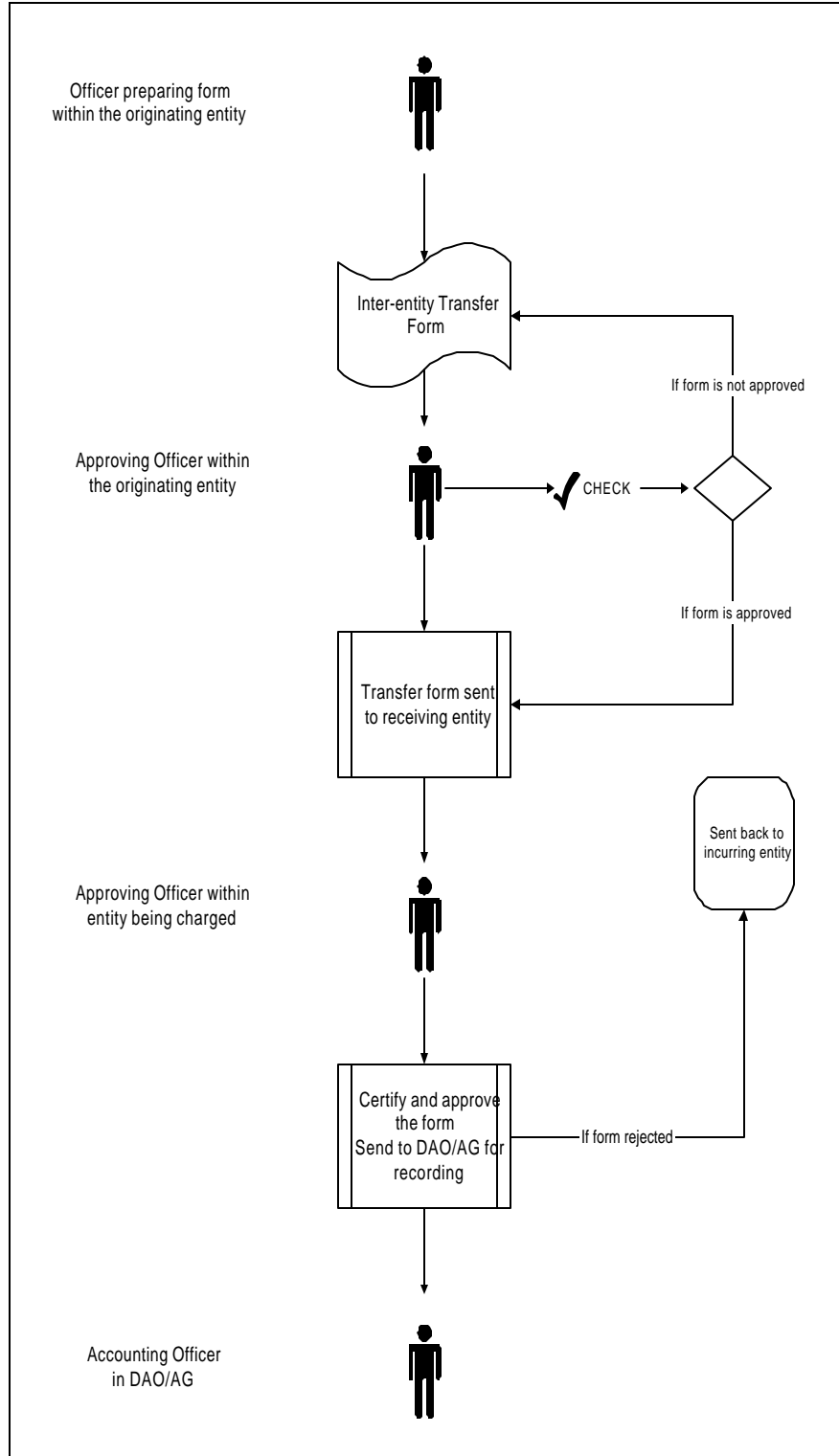



12.5.4.2 Inter-entity transfer forms [Form12A] shall be prepared and approved by the entity in which the transaction originates. The form will therefore be prepared by the entity acting as agent or performing the service and submitting the charge.

12.5.4.3 All appropriate supporting documentation should be included with the forms.

12.5.4.4 The entity acting as agent/submitted the charge must present all the vouchers to the delegated authority of the receiving entity each month. This may be performed at the Clearing House meeting.

12.5.4.5 The forms must be approved by the entity ultimately receiving the goods/services, prior to recording the inter-entity transaction or transfer of cash.

**12.5.5 Recording of inter-entity transactions in the office of DAO/AG/AGPR**

12.5.5.1 Overview

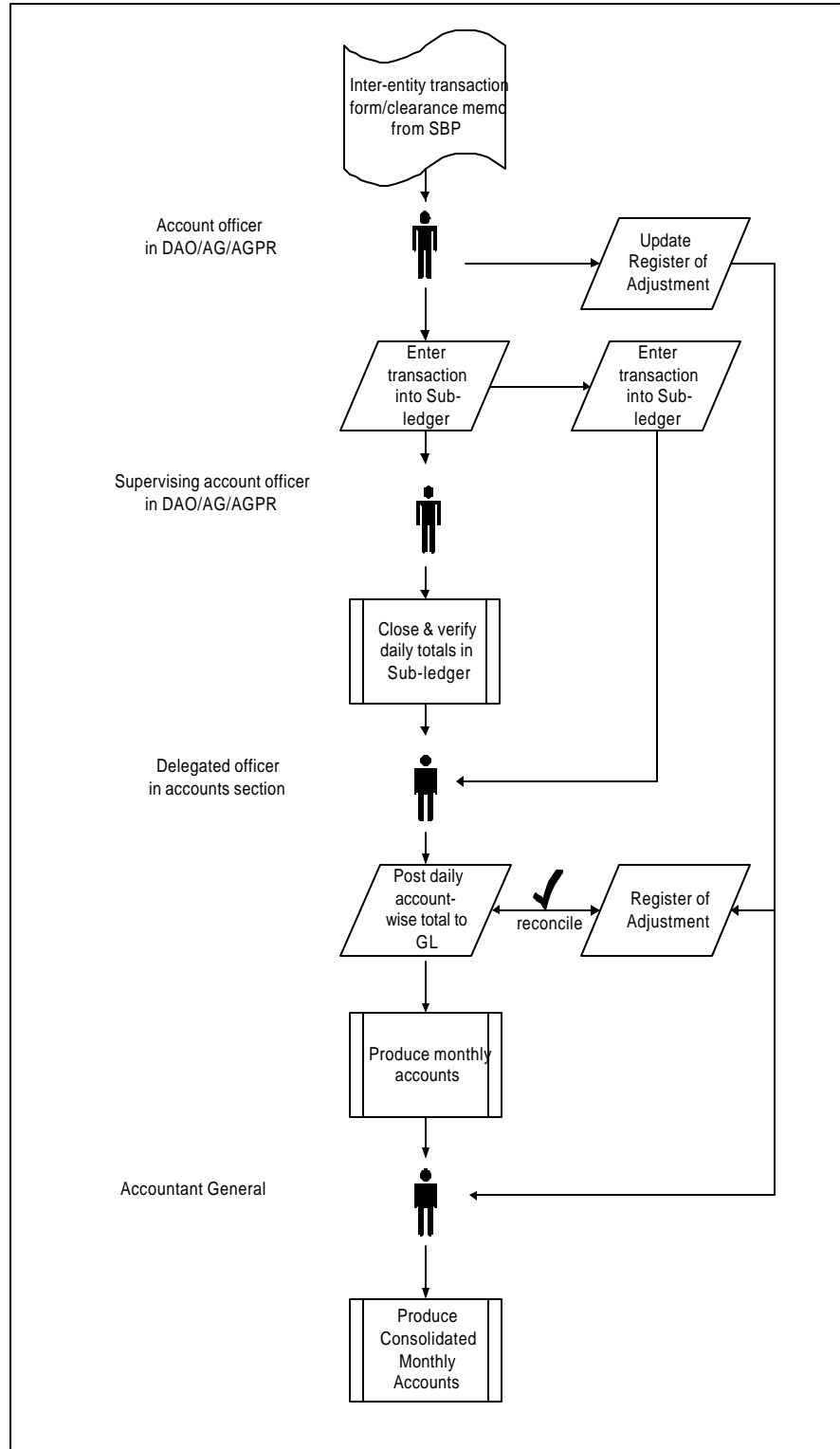

- 12.5.5.2 The delegated officer in the Accounts Section of the DAO/AG/AGPR shall record the expenditure being incurred and subsequently the recovery of the expenditure in the entity transferring the costs.
- 12.5.5.3 The delegated officer in the Accounts Section must record the details of the expenditure, as stated on the authorised inter-entity transfer form, in the 'Register of Adjustments' [Form 12C] and in the expenditure Sub-ledger, in accordance with the directions in the Accounting Treatment section (Direction 12.4.3).
- 12.5.5.4 The total of transactions in the register must be reconciled with transaction forms.
- 12.5.5.5 The register must be reconciled with the transactions posted to the GL.
- 12.5.5.6 At the end of the day on which the postings are made, the Sub-ledger must be closed, verified and signed off by a delegated authority.
- 12.5.5.7 The delegated officer must prepare abstracts as required for posting from the Sub-ledger to the General Ledger.
- 12.5.5.8 The delegated officer must then make arrangements for the transfer of funds, where necessary.
- 12.5.5.9 Both Account Offices must record the transfer of cash in the Sub-ledgers, on issue of the cheque or advice note to the Central Accounts section of SBP, giving the details, in accordance with directions in the Accounting Treatment section (Direction 12.4.3).
- 12.5.5.10 Federal adjustments occurring at DAO and sub-treasuries must be submitted to the Provincial Accountant General on a weekly basis for consolidation. The Accountant General must compile these transactions in a 'Register of Adjustments'. This consolidated advice must be sent to the Central Accounts Section of the SBP, who will then perform the required cash adjustments, on at least a monthly basis.

## 12.5.6 Inter-entity transfer of funds

### 12.5.6.1 Overview

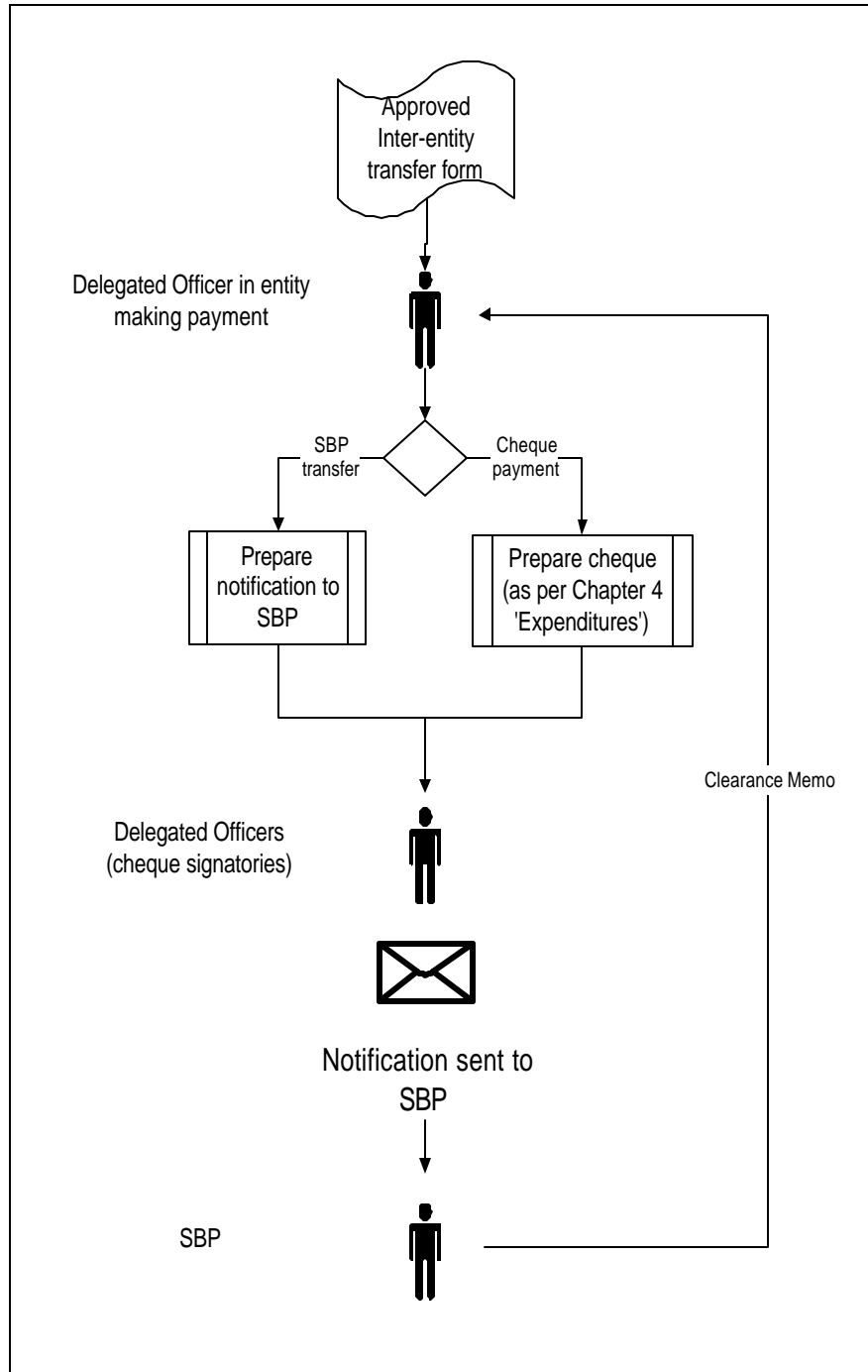

12.5.6.2 Once the relevant officer has authorised the inter-entity transaction form there are two possibilities for proceeding:

- if the entities involved in the transaction maintain the same bank account the transaction requires no transfer of funds

- if the entities involved maintain different bank accounts a transfer must be made.

12.5.6.3 The delegated authority in the entity required to make the payment must prepare an advice note [Form 12B] and send it to the Central Accounts Section of the SBP to initiate the transfer. This advice note must be copied to all other entities party to the transaction. The advice note must instruct the Director of the Central Accounts Section of the SBP to debit/credit the originating entity with the total balance of the transactions and debit/credit the other party to the transaction with the appropriate cash balances.

12.5.6.4 The SBP must issue both entities to the transfer with a clearance memo to inform them that the transfer has taken place. The accounts officers shall record the transfer of the cash on receipt of this memo in the Register of Adjustments and the Sub-ledger.

12.5.6.5 Where the value of the transaction is below a set monetary threshold the settlement may be in the form of a cheque rather than a transfer of funds. The procedure for issuing the cheque must be in accordance with those set out in Chapter 4 'Expenditures'.

### **12.5.7 Consolidation of inter-entity transactions**

12.5.7.1 The Accountant General offices must perform monthly consolidation of divisions/department accounts.

12.5.7.2 Inter-entity account balances within the same government shall be recognised in the accounts of the individual entity, but cancelled out on consolidation. Only balances with other Governments should remain. Any reconciling items must be investigated by the Accountant General's office and resolved prior to issue of the Consolidated Monthly Accounts. Consequently the balances should not be recognised in the Consolidated Monthly Accounts.

12.5.7.3 Inter-entity account balances between governments shall be recognised in the separate accounts of each government, but cancelled out on consolidation in the Federal and Provisional Government's accounts.

### **12.5.8 Reporting of inter-entity transactions**

12.5.8.1 Inter-entity transactions must be included in the monthly reports by the District Accounts office to the Accountant Generals

12.5.8.2 Subsequently inter-department balances must be eliminated on consolidation, leaving the inter-Government balances to be reported

by the Accountant General in the Consolidated Monthly Accounts for the Provincial/Federal Government.

### **12.5.9 Reconciliation of inter-entity balances**

12.5.9.1 The Accountant General offices must perform monthly consolidation of department accounts (Direction 12.5.7) within the Governments to control the complete and accurate recording of inter-department transfers.

12.5.9.2 The delegated officer in the Account Section of the DAO/AG/AGPR office must prepare a bank reconciliation (Chapter 6) to control the complete and accurate transfer of funds between entities with different bank accounts.

# **13 Procurement and Asset Management**

---

## Table of Contents

<b>13.1</b>	<b>Introduction</b>	<b>13.3</b>
<b>13.2</b>	<b>General Policies for Procurement</b>	<b>13.4</b>
13.2.1	Segregation of duties	13.4
13.2.2	Overseas procurement	13.4
13.2.3	Inter-entity procurement	13.4
13.2.4	Approval of procurement and commitment	13.4
<b>13.3</b>	<b>Accounting for Stores</b>	<b>13.5</b>
13.3.1	Stores	13.5
13.3.2	Stores accounts	13.5
13.3.3	Segregation of duties	13.5
13.3.4	Receipt of stores	13.5
13.3.5	Issue of stores	13.6
13.3.6	Stocktaking	13.6
<b>13.4</b>	<b>Fixed Assets Management</b>	<b>13.8</b>
13.4.1	Recording of fixed assets	13.8
13.4.2	Responsibility for fixed assets recording	13.9
13.4.3	Donations/gifts of fixed assets	13.9
13.4.4	Accounting for fixed assets	13.9
13.4.5	Reporting of fixed assets	13.10
<b>13.5</b>	<b>General Policies for Disposal of Fixed Assets</b>	<b>13.11</b>
13.5.1	General principles	13.11
13.5.2	Disposal of assets to other government departments/entities	13.11
13.5.3	Trade-ins and swaps	13.11
<b>13.6</b>	<b>Accounting for Proceeds from Disposals</b>	<b>13.13</b>
13.6.2	Accounting entries	13.13



### **13.1 Introduction**

- 13.1.1.1 This chapter covers accounting policies and principles associated with the purchasing process and in relation to accounting for stores and fixed asset management.
- 13.1.1.2 This chapter does not deal with purchasing policies, rules and guidelines in relation to tendering, advertisement, ordering, receipt, quality certification and control of goods and services. Such policies, rules and guidelines are available in the Manual Office Procedures (Purchase) issued by the Department of Supplies, Federal and Provisional Government, which acts as the centralized purchase agency on behalf of most of the civil departments of the Federal Government, or in Purchase Manuals of other entities such as Defence and Railways.
- 13.1.1.3 In the case of Provinces, such policies, rules, and guidelines are contained in the Purchase Manuals of Industries Department, and for specific items, such as medicines, in the Purchase Manuals of the respective departments.

## **13.2 General Policies for Procurement**

### **13.2.1 Segregation of duties**

- 13.2.1.1 The PAO (or his/her delegated offices) of an entity should ensure that there is an appropriate segregation of duties between staff who approve purchase orders, those who place orders, and those who receive the goods or services.
- 13.2.1.2 For centralised accounting entities, all payments shall be certified and authorised by the DAO/AG/AGPR office as set out in the Chapter 4 “Expenditures” of this Manual. For self-accounting entities, the PAO of that entity should ensure that there is an appropriate segregation of duties between staff who authorise and make payment.
- 13.2.1.3 The PAO (or his/her delegated offices) should also ensure that all officers responsible for the procurement of goods and services are aware of (by circulation of guidelines and notices to concerned officers) the procurement guidelines issued by the Government and also any guidance on purchasing practices which is issued from time to time by the Government.

### **13.2.2 Overseas procurement**

- 13.2.2.1 For overseas procurement carried out through the Department of Industries, Supplies and Food, the policies and procedures as set by the Department of Industries, Supplies and Food should be followed.
- 13.2.2.2 Where a department/entity needs to use the facilities of an overseas office of the Department of Foreign Affairs for the procurement of certain supplies, the policies and procedures as set by the delegated authority should be followed.

### **13.2.3 Inter-entity procurement**

- 13.2.3.1 Accounting treatment of procurement relating to inter-department/entity, refer to chapter 12 "Transactions between Government Entities".

### **13.2.4 Approval of procurement and commitment**

- 13.2.4.1 In relation to approval of procurement, including commitments entered for procurement, the policies as set out in sections 4.2.2. and 4.3.3. of chapter 4 of this Manual shall be followed.

### **13.3 Accounting for Stores**

#### **13.3.1 Stores**

- 13.3.1.1 Stores are defined as consumable items or goods acquired not for resale, which are the property of, in the possession or under the control of the department/entity.
- 13.3.1.2 Expenditure on stores incurred in the departments shall be included under contingent expenditure (except where it is treated otherwise e.g. stores relating to works).

#### **13.3.2 Stores accounts**

- 13.3.2.1 These are subsidiary accounts kept by the department/entity for the purpose of recording and maintaining stores.
- 13.3.2.2 Each department/entity managing stores shall issue directions to cover detailed procedures for stores accounting and control.
- 13.3.2.3 Stores accounts should be built up from properly authorised vouchers recording stores transactions.
- 13.3.2.4 In practice the amount of detail in stores accounts is likely to vary, and in devising systems, department/entity should pay regard to cost effectiveness. Factors to be taken into account will include the nature of the items being held, their value and attractiveness.
- 13.3.2.5 Procedures issued by the department/entity should enable separate orders to be traced through each of the order, receipt and payment processes, and for the necessary cross checks to be carried out.

#### **13.3.3 Segregation of duties**

- 13.3.3.1 Control of stores records rests with a delegated officer(s) within the department/entity.
- 13.3.3.2 While other people may be allowed access to the records for operational reasons, any adjustment of the stores accounts should only be made by the delegated officer(s).
- 13.3.3.3 The tasks of ordering stores, checking deliveries and approving payments should be separated wherever possible.

#### **13.3.4 Receipt of stores**

- 13.3.4.1 All stores should be examined, by a delegated officer within the department/entity, on receipt of goods to ensure that there is a valid

purchase order, that the correct quantities and qualities have been received, and that they are in good condition.

13.3.4.2 Appropriate action should be taken by the delegated officer within the department/entity if unsolicited goods are received or if quantities or qualities are wrong, or if the goods are not in good condition.

13.3.4.3 Where goods are received from within the department/entity (i.e. from another departmental store) or from another department/entity, the issuing store will prepare an issue voucher and send copies to the recipient, who should return a signed copy. This signed copy of the issue voucher shall be kept by the issuing store for reconciling of goods.

13.3.4.4 The recipient should ensure that the goods are checked, that any discrepancies are resolved, and both the sender and the recipient will ensure that their records are updated.

### **13.3.5 Issue of stores**

13.3.5.1 The PAO should ensure that within their department/entity, the departmental procedures lay down:

- arrangements for demanding issue of goods from stores. These arrangements should, inter alia, specify those entitled to acquisition stores, the circumstances in which stores may be demanded, and the procedure for making demands (including the signing of requisitions)
- procedures for issuing stores. These should cover, for example, instructions to store keepers on the conditions to be satisfied before stores may be released, and the arrangements for obtaining signed receipts
- procedures for recording stores issues
- arrangements for reconciling stores demands and stores issues

### **13.3.6 Stocktaking**

13.3.6.1 The delegated officer(s) shall ensure that the balances recorded in stores accounts are regularly checked by stocktaking, at least once in a year.

13.3.6.2 The condition of goods should also be examined.

13.3.6.3 The immediate purpose of stocktaking is to deter and detect losses by theft and fraud, to verify the accuracy of stock records, and to identify any weaknesses in custody arrangements.

- 13.3.6.4 The PAO must ensure that the arrangements for stocktaking will provide management with an independent verification of the contents and the state of stores. This is achieved by proper procedures for stocktaking issued by the PAO.
- 13.3.6.5 The stocktaking will be carried out under the overall supervision of Internal Audit Officer. If stores accounts or store keeping staff are required to assist, the Internal Audit Officer should ensure that this will not prejudice the independence of stocktaking.
- 13.3.6.6 Discrepancies between stocktake and store accounts should be investigated by the delegated officer(s) and store accounts amended if necessary.
- 13.3.6.7 Any adjustments to store accounts shall be made only on the authority of an officer authorised by the department/entity. Such adjustments shall be supported by reference to the relevant stocktaking reports and to the authority for the adjustments.
- 13.3.6.8 A copy of the stocktaking report shall be sent to the concerned DAO/AG/AGPR.

## 13.4 Fixed Assets Management

### 13.4.1 Recording of fixed assets

13.4.1.1 All departments/entities will maintain a "Fixed Assets Register" (form 13A) for the categories of assets, for which they are responsible. The categories of assets shall include the following:

- land & building
- civil works
- plant and machinery
- vehicles
- furniture & fitting
- office equipment
- computer equipment

13.4.1.2 The following information shall be kept on the Fixed Assets Register for each asset.

- description
- classification of asset
- date of purchase or date of completion
- original purchase cost in Rupees
- cost in foreign currency (where applicable)
- asset identification number
- current location
- ownership of/responsibility for asset

13.4.1.3 The above data is the minimum required for the proper management of fixed assets.

13.4.1.4 Every fixed asset purchased or improvement/extension made above Rs 100,000 shall be recorded in the Fixed Assets Register. This threshold should be subsequently adjusted in the light of experience and better defined management information requirements.

13.4.1.5 The record of each item shall also include references to the relevant files, plans and deeds, source of acquisition, and give other relevant details such as rents payable or receivable, and restrictive covenants.

13.4.1.6 Every change affecting the ownership, occupation or change in location of the asset shall be the subject of an entry in the register.

**13.4.2 Responsibility for fixed assets recording**

- 13.4.2.1 The PAO shall ensure that the Fixed Assets Register kept in his/her department/entity is properly maintained and is up-to-date.
- 13.4.2.2 Departments/entities will regularly review their holdings of fixed assets (including land & building, plants, machinery, furniture & fittings, office equipment, computers etc.) in order to match with the fixed assets records and to identify surplus assets.
- 13.4.2.3 The Fixed Assets Register will be maintained by a delegated officer within the department/entity who should take appropriate precautions to safeguard the accuracy and integrity of the record.
- 13.4.2.4 Any entry in the register will only be made by an authorised officer who will sign it on every entry.
- 13.4.2.5 No item will be removed from the register except under proper authority. When an item is removed the record should be noted to show the date and reasons for removal and the reference of the relevant written authority.
- 13.4.2.6 Where an asset is jointly owned by more than one department/entity, the Fixed Assets Register will be kept by the nominated controlling department/entity.

**13.4.3 Donations/gifts of fixed assets**

- 13.4.3.1 Donations or gifts of fixed assets may be received by a department/entity with the approval of the PAO.
- 13.4.3.2 The value of the assets donated or gifted shall be in accordance with guidelines set by the Government.
- 13.4.3.3 Donations or gifts of fixed assets by department/entity may be made only on the authority of the MoF. Such assets shall be removed from the Fixed Assets Register on the date the fixed assets is donated or gifted.

**13.4.4 Accounting for fixed assets**

- 13.4.4.1 A memorandum account for fixed assets shall be kept by the DAO/AG/AGPR to record transactions relating to fixed assets.
- 13.4.4.2 Where claims are made in relation to expenditures for fixed assets, the claim voucher submitted to the DAO/AG/AGPR shall also include information on Fixed Assets Form (form 13B) .

13.4.4.3 When the delegated officer in the Account Section of the DAO/AG/AGPR records the expenditure, in accordance with section 4.4 of chapter 4 of this Manual, he/she shall, at the same time, also record the relevant information, as submitted with the claim voucher, in the fixed assets account (kept as a memorandum account by DDO-wise).

### **13.4.5 Reporting of fixed assets**

13.4.5.1 All PAOs shall prepare a fixed assets report, by DDO-wise, from the Fixed Assets Register on a quarterly basis. This quarterly report, in a prescribed form (see section 2.2.7 of FRM) , shall be sent to the concerned Accountant General.

13.4.5.2 All DAOs shall also prepare a fixed assets report, by DDO-wise, from the fixed assets account on a quarterly basis. This quarterly report, in a prescribed form (see section 2.2.7 of FRM), shall be sent to the concerned Accountant General.

13.4.5.3 The Accountant General shall check the quarterly report send by the PAOs with the data in the fixed assets account and investigate any differences.

13.4.5.4 The Accountant General shall consolidate the information for including into the Annual Accounts.



## **13.5 General Policies for Disposal of Fixed Assets**

### **13.5.1 General principles**

- 13.5.1.1 Surpluses should be sold as quickly as possible, subject to value for money considerations and guidelines set by the Government in relation to disposal of assets.
- 13.5.1.2 Surplus assets shall be sold on the open market by means of public auction or tender.
- 13.5.1.3 Where open market value is not available, department/entity should follow guidelines set by the Government in order to use their own valuers, the District Valuer or a suitably qualified private sector valuer.
- 13.5.1.4 Departments/entities shall ensure that appropriate systems of control are instituted over the disposals of assets. In particular they should ensure that the staff concerned are properly supervised and that duties are adequately separated; for example that staff responsible for selling assets do not also value them.
- 13.5.1.5 Where a loss of asset has taken place, it shall be taken off the Fixed Assets Register and included in the Loss Register as set out in section 8.3.2 of chapter 8 of this Manual.

### **13.5.2 Disposal of assets to other government departments/entities**

- 13.5.2.1 The transfer of assets by one department/entity to another will be treated as an arms length transaction i.e. the asset will be sold on cash basis instead of as a book entry going through some settlement/exchange account.
- 13.5.2.2 On transfer the asset shall be removed from the Fixed Assets Register by a delegated officer within the department/entity. The delegated officer shall also inform the DAO/AG/AGPR of this transfer, who shall make the adjustment in the fixed assets account.
- 13.5.2.3 If the department/entity receiving the asset is under the jurisdiction of another DAO/AG/AGPR, that department/entity shall inform the concerned DAO/AG/AGPR of the assets transferred, on the Fixed Assets Form.

### **13.5.3 Trade-ins and swaps**

- 13.5.3.1 Each trade-in arrangement will only be approved by a delegated officer within a department/entity having the authority to incur expenditure representing the gross value of the purchase transaction,

i.e. actual expenditure plus the value given by the supplier for the items traded-in.

13.5.3.2 Similarly, swap arrangements shall be approved in each case by a delegated officer empowered to incur expenditure equal to the estimated gross value of the items being acquired in the swap.

13.5.3.3 On trade-ins or swaps the asset traded-in or swapped shall be removed from the Fixed Assets Register and new asset shall be added to the Fixed Assets Register by a delegated officer within the department/entity.

13.5.3.4 The delegated officer shall also inform the DAO/AG/AGPR of this trade-in or swap, who shall make the adjustment in the fixed assets account.

### 13.6 Accounting for Proceeds from Disposals

- 13.6.1.1 Receipts from the sale of fixed assets shall be credited to the appropriate account head in the relevant Federal or Provincial Consolidated Fund.
- 13.6.1.2 Sale receipts shall be accounted for on a gross basis. Sale expenses will not be netted off the sale proceeds but shall be separately accounted for as an expenditure item.
- 13.6.1.3 In relation to disposal of assets to other government department/entity, the value of the asset on transfer will be its original cost, as recorded in the books of transferee department.

#### 13.6.2 Accounting entries

- 13.6.2.1 The double entry in relation to proceeds from disposal is as follows.

Dr		Bank account
	Cr	Revenue head account

[to record proceeds from disposal of fixed asset]

**Also**

	Cr	Fixed assets account
--	----	----------------------

[to record disposal of fixed asset in the memorandum account]

- 13.6.2.2 The double entry for trade-in is as follow.

Dr		Expenditure head account
	Cr	Bank account

[to record the net expenditure incurred during trade-in of fixed asset]

**Also**

Dr		Fixed assets account (new asset)
	Cr	Fixed assets account (old asset)

[to add the new asset and remove the old asset during a trade-in, from the memorandum account]

13.6.2.3 The double entry for swap is as follow.

Dr	Fixed assets account (new asset)
Cr	Fixed assets account (old asset)

[to add the new asset and remove the old asset during a swap, from the memorandum account]

# **14 Public Account Transactions**

---

**Table of Contents**

<b>14.1</b>	<b>Introduction</b>	<b>14.3</b>
<b>14.2</b>	<b>General Policy</b>	<b>14.4</b>
14.2.1	Definition	14.4
14.2.2	Application	14.4
14.2.3	Classification	14.4
<b>14.3</b>	<b>Accounting Policy</b>	<b>14.6</b>
14.3.1	General	14.6
14.3.2	Accounting records	14.6
14.3.3	Accounting entries	14.6
<b>14.4</b>	<b>Detailed Procedures</b>	<b>14.9</b>
14.4.1	Introduction	14.9
14.4.2	Public Account receipts	14.9
14.4.3	Public Account payments	14.10
14.4.4	Other transactions	14.11
<b>14.5</b>	<b>Reconciliation of Public Account transactions</b>	<b>14.12</b>
<b>14.6</b>	<b>Reporting of Public Account balances</b>	<b>14.13</b>

## **14.1 Introduction**

14.1.1.1 This chapter deals with the accounting for Public Account transactions and reporting of Public Account balances.

## 14.2 General Policy

### 14.2.1 Definition

14.2.1.1 Article 78 (1) and (2) of the Constitution of Pakistan defines the Federal Consolidated Fund and Public Account of the Federation as follows:

- ‘All revenues received by the Federal Government, all loans raised by that Government, and all monies received by it in repayment of any loan, shall form part of a consolidated fund, and shall be known as the Federal Consolidated Fund’.
- ‘All other monies:
  - a) received by or on behalf of the Federal Government; or
  - b) received by or deposited with the Supreme Court or any other court established under the authority of the Federation

shall be credited to the Public Account of the Federation’.

14.2.1.2 A similar provision exists within the Provincial section of the Constitution (Article 118) defining the Provincial Consolidated Fund and the Public Account of a Province. Therefore, a separate Public Account will exist for the Federal Government and each of the Provincial Governments.

### 14.2.2 Application

14.2.2.1 The Public Account represents those monies for which the Government has a fiduciary duty but which it is not at liberty to appropriate for the general services of the Government.

### 14.2.3 Classification

14.2.3.1 The Public Account consists of trust accounts and special deposit accounts. These are defined as follows:

- **trust accounts** - legal entities in their own right, under the stewardship of the Government, and as such expected to produce financial statements in their own name. These trust accounts are normally established under an Act of Parliament or Presidential Order.

Examples of trust accounts include provident and benevolent funds, employee’s insurance funds and trust accounts of certain departments (eg. Railways).

- **special deposit accounts** - those accounts comprising of Public Account monies that are operated under the authority of the



Ministry of Finance, but are not trusts. As they are not legal entities, reporting would be generally by way of statements of receipts and payments.

Examples of special deposit accounts include relief funds, civil and criminal court deposits, welfare funds and development funds.

- 14.2.3.2 Classes of trust accounts and special deposit accounts will exist at major and detailed heads, as provided in the Chart of Accounts. In the Chart of Accounts the detailed Public Account head will be given by the 'Fund' element. Both the receipts and payments of a particular trust account or special deposit account shall be charged to these heads.

### 14.3 Accounting Policy

#### 14.3.1 General

14.3.1.1 No authority shall incur expenditure or enter into any commitment involving expenditure from the Public Account, unless it is sanctioned under the governing Act, Order or other regulation for the particular trust account or special deposit account.

14.3.1.2 The balances held in Public Account heads shall be carried forward from year to year, in accordance with the relevant Acts, Presidential Orders or other statutes governing each trust fund and special deposit account.

#### 14.3.2 Accounting records

14.3.2.1 Each transaction occurring in the Public Account shall be recorded in the Sub-Ledger of the DAO/AG/AGPR against the appropriate detailed account head, in accordance with the detail prescribed in Direction 4.4.4.2 of this Manual (Expenditures).

14.3.2.2 The General Ledger shall record all expenditures and receipts of the Public Account on a daily totals basis for each detailed account head, in accordance with the detail prescribed in Direction 4.4.4.4 of this Manual (Expenditures).

14.3.2.3 The balance contained in the Budget Head Register, for each of the Public Account heads, represents the funds sanctioned for expenditure to be incurred against that head.

14.3.2.4 Records of financial assets and liabilities shall be maintained for each trust account in the Public Account by the AG/AGPR offices. The Public Account records will be kept in a separate register to the Consolidated Funds records. This will be called the "Public Accounts Register". These records shall be updated on a progressive basis.

#### 14.3.3 Accounting entries

14.3.3.1 The following accounting entries relating to Public Account transactions shall be made in the Sub-Ledger/General Ledger:

**14.3.3.2 Receipts** - receipts shall be recorded in the Public Account as follows:

Dr	Bank Account (Public Account)
Cr	Relevant Public Account Head

---

[to record receipt of cash into Public Account - at detailed head level].

14.3.3.3 For non-reciprocal contributions, such as public donations to particular fund, no liability will arise, as the funds are not expected to be repaid to the contributor.

14.3.3.4 However for reciprocal contributions, such as deposits into a savings scheme or contributions by Government employees into a provident fund, the amount deposited shall be eventually returned to the contributor, thus creating a liability. In these cases, the liability record / register shall be updated to reflect the increased liability on the Government to repay the funds.

14.3.3.5 The liability records shall be adjusted from time to time to record subsequent events. For example, where civil or criminal court deposits which are later forfeited (i.e. through a breach in conditions) the amount forfeited should be transferred into the Consolidated Fund as revenue and the liability record reduced accordingly.

**14.3.3.6 Payments** - the following entry shall be recorded when a payment is made, as approved expenditure under the rules and regulations of a trust (e.g. disaster relief fund), or as repayment of a previously deposited amount (e.g. savings scheme or court deposit):

Dr	Relevant Public Account Head
Cr	Bank Account (Public Account)

[to record payment from the Public Account - at detailed head level].

14.3.3.7 In the case of repayments of deposits (e.g. savings schemes), the liability record/register shall be updated to reflect the decrease in liability arising from the payment.

**14.3.3.8 Transfers to and from the Consolidated Fund** - where funds held in the Public Account are utilised in operations by the Government, the amount transferred to the Consolidated Fund should be also recorded as a receivable and payable.

14.3.3.9 When Public Account funds are transferred to the Consolidated Fund, the following entries shall be recorded:

Dr	Relevant Public Account Head
Cr	Bank Account (Public Account)

[to record the transfer of cash out of the Public Account].

Dr	Bank Account (Consolidated Fund)
----	----------------------------------

---

Cr	Public Account Receipts (CF)
----	------------------------------

[to record the receipt of cash into the Consolidated Fund].

14.3.3.10 At the same time the above entries are made, the asset (receivable) records shall be updated to reflect the increase in amount receivable to the relevant trust fund and the liability records updated to reflect the increase in amount payable from the Federal and Provisional Government.

14.3.3.11 When the Government makes a repayment to the Public Account, the following entry shall be made:

Dr	Bank Account (Public Account)
Cr	Relevant Public Account Head

[to record the receipt of cash into the Public Account].

Dr	Relevant Expenditure Head (CF)
Cr	Bank Account (Consolidated Fund)

[to record the transfer of cash out of the Consolidated Fund].

14.3.3.12 At the same time the above entries are made, the asset records shall be updated to reflect the decrease in amount receivable to the relevant trust fund and the liability records updated to reflect the decrease in amount payable from the Federal and Provisional Government.

## 14.4 Detailed Procedures

### 14.4.1 Introduction

14.4.1.1 The key controls to be observed in respect of Public Account transactions are as follows:

- withdrawals from any trust account or special deposit account established in the Public Account must be for the purpose laid out in its governing Act or Presidential Order, and other regulations prescribed by the Government
- all withdrawals from the Public Account, shall be duly approved by a delegated authority
- withdrawal from a Public Account head shall only be permitted up to the balance of the fund, as given in the Budget Head Register. The amount withdrawn shall be subject to the available cash limit sanctioned by the Ministry of Finance.

### 14.4.2 Public Account receipts

14.4.2.1 Public Account receipts may be collected through the following mechanisms:

- at a branch of the National Bank or State Bank of Pakistan, for Public Account receipts generally
- at a National Savings Centre, Post Office or commercial bank in relation to savings and deposit schemes (savings accounts, defence certificates, prize bonds etc.)
- at a court, in relation to court deposits.

14.4.2.2 In all cases above, the receipts collected from the various sources shall be submitted to a designated branch of the National Bank of Pakistan or State Bank of Pakistan, which are then submitted, by bank scroll, to the respective DAO/AG/AGPR office.

14.4.2.3 The procedures for recording Public Account receipts by the DAO/AG/AGPR shall be in accordance with the procedures laid down in Chapter 5 of this Manual, 'Receipts'. The DAO's record of Public Account receipts shall be submitted each month to the relevant AG/AGPR office for consolidation.

14.4.2.4 Monies deposited into the Public Account shall, unless otherwise specified, increase the balance of the particular trust account or special deposit account, as indicated in the General Ledger of the DAO/AG/AGPR.

---

### 14.4.3 Public Account payments

14.4.3.1 Payments from the Public Account vary according to the type of trust account or special deposit account being used. They can be summarised into the following categories:

- general payments, such as expenditure from a disaster relief fund, welfare fund or refugee fund
- withdrawals from savings bank deposits, savings certificates and deposit certificates
- payments / refunds in relation to court deposit refunds
- payments to employees (e.g. GP fund final payment)
- payments from personal ledger accounts

14.4.3.2 General payments made from the Public Account shall broadly follow those procedures covered in Section 4.5 of this Manual (Chapter 4, 'Expenditures'). The key steps outlined in this Section are:

- approval of expenditure by a delegated authority
- preparation of claim voucher, with supporting documents
- registration of claim voucher by DAO/AG/AGPR office
- certification and authorisation of claim voucher by the DAO/AGPR/AG office
- issue of payment by the DAO/AG/AGPR to the claimant, as indicated on the claim voucher, including funds clearance.
- issue of daily advice note by DAO/AG/AGPR to designated bank branch
- recording of expenditure in Sub-Ledger and General Ledger and updating of asset and liability records accordingly
- monthly consolidation of accounts by AG office.

14.4.3.3 The authority delegated to incur expenditure from the relevant trust fund or special deposit account shall first obtain a letter of sanction from the MoF providing the authority to spend funds from that account up to an allocated limit. This sanction shall also be communicated to the AG/AGPR office who will then inform the relevant DAO to which the claim will be submitted. The DAO shall then enter this amount into the Budget Head Register. When the claim voucher is submitted to the DAO, a copy of the MoF sanction shall be provided.

14.4.3.4 Withdrawals from savings bank deposits, savings certificates and deposit certificates may be made from a number of locations, depending on the type of scheme involved, including post offices,

---

national savings centres and banks. All of these institutions shall report details of withdrawals made against each Public Account head to the designated branch of the NBP or SBP, for submission (through bank scroll) to the relevant DAO/AG/AGPR.

14.4.3.5 Refunds of civil and criminal court deposits shall be obtained from the designated NBP/SBP bank branch into which the deposit was made, upon sanction by the concerned court. The subsequent accounting transaction shall be recorded by the DAO/AG/AGPR from the daily scroll received from the relevant bank branch.

14.4.3.6 Procedures for final payments and advances made in relation to GP fund are indicated in Section 4.8 of this Manual (Chapter 4, 'Expenditures').

14.4.3.7 Withdrawals from personal ledger accounts, where these have been established, shall be made through the DAO/AG/AGPR in accordance with the guidance provided in Chapter 10 of this Manual 'Project Accounting'.

14.4.3.8 Monies withdrawn from the Public Account shall, unless otherwise specified, decrease the balance of funds available against the particular trust account or special deposit account in the Budget Head Register, and also be reflected in the balance contained in the General Ledger.

#### **14.4.4 Other transactions**

14.4.4.1 Another class of transactions in the Public Account is transfers made to or from the Consolidated Fund. These types of transactions must first be sanctioned by a delegated authority in the MoF, and communicated to the AG/AGPR office for recording in the General Ledger.

14.4.4.2 From time to time certain funds in the Public Account may be utilised by the Government in meeting expenditures. Authorised payments can also be made from the Consolidated Fund into the Public Account, provided there is budgetary provision under the Schedule of Authorised Expenditure. These include payments into renewal reserve funds, depreciation funds and other trust accounts.

14.4.4.3 The accounting entries for such transfers are indicated in Section 14.3.7 of this Chapter.

**14.5 Reconciliation of Public Account transactions**

- 14.5.1.1 Cash transactions relating to the Public Account shall be reconciled as part of the routine monthly bank reconciliation process, in accordance with Chapter 6 of this Manual, 'Bank Reconciliation'.



**14.6 Reporting of Public Account balances**

- 14.6.1.1 A 'Public Account Summary Schedule' shall be produced by each DAO as part of the monthly consolidation pack submitted to the AG/AGPR as specified in the Financial Reporting Manual.
- 14.6.1.2 The Public Account Summary Schedule shall contain, for each trust account and special deposit account, the receipts and payments for the month. Refer to Section 2.4 of the Financial Reporting Manual for the format of this report.
- 14.6.1.3 In the monthly 'Statement of Cashflows' a section containing details of all major heads in the Public Account shall be produced by DAO's and submitted each month to the AG/AGPR, as specified in the Financial Reporting Manual.
- 14.6.1.4 The cashflow report shall show the net increase or decrease in cash for the month and year to date for each major Public Account head.
- 14.6.1.5 Trust Accounts within the Public Account shall also provide financial statements in accordance with their governing Acts, Orders and Regulations.
- 14.6.1.6 The Federal and Provisional Government Statement of Assets and Liabilities shall include, as liabilities, balances of any amounts payable to Public Account trust accounts and special deposit accounts. Refer to the Financial Reporting Manual, Section 3.3 'Statement of Assets and Liabilities' for the format of this report.

# 15 Insurance

---

**Table of Contents**

<b>15.1</b>	<b>Introduction</b>	<b>15.3</b>
<b>15.2</b>	<b>General Policies</b>	<b>15.4</b>
15.2.1	Introduction	15.4
15.2.2	Insurance of property owned or hired by the Government	15.4
15.2.3	Group insurance for government employees	15.4
<b>15.3</b>	<b>Claims Against the Government</b>	<b>15.5</b>
15.3.1	General policies	15.5
15.3.2	Claims against the Government for personal injury	15.5
15.3.3	Settlement of claims	15.5
<b>15.4</b>	<b>Accounting Policies</b>	<b>15.7</b>
15.4.2	Accounting entries	15.7

**15.1 Introduction**

15.1.1.1 This chapter covers the accounting policies and procedures relating to insurance.

15.1.1.2 For detail rules and guidelines on government insurance policies, refer to MoF's relevant rules and regulations.

## **15.2 General Policies**

### **15.2.1 Introduction**

- 15.2.1.1 The purpose of obtaining insurance is to indemnify the insurer in the event of loss or other event covered by the insurance.
- 15.2.1.2 In most cases the Government itself is its own insurer.
- 15.2.1.3 Any claim on the Government is to be administered and settled by the Government, under the guidance of the Justice Division/Department.
- 15.2.1.4 In certain cases, a Ministry or Department may choose to manage its own risks and insure against certain losses, where it is commercially viable to do so. In such cases that Ministry or Department should follow rules and guidelines set by the MoF.

### **15.2.2 Insurance of property owned or hired by the Government**

- 15.2.2.1 For the insurance of property owned or hired by the department/entity, the Principal Accounting Officer shall follow rules and guidelines set by the MoF or by his/her department/entity.
- 15.2.2.2 In accepting insurable risks on behalf of the Government the Principal Accounting Officer shall ensure that:
- the property is under effective government control and all safeguards are exercised against the occurrence of risks for which the Government is acting as insurer
  - there is a clear line of demarcation between property for which the Government accepts the risks and property for which it does not

### **15.2.3 Group insurance for government employees**

- 15.2.3.1 The policies and procedures relating to group insurance for government employees are covered in the Employees Benevolent Fund and Group Insurance Act, 1969.

---

## **15.3 Claims Against the Government**

### **15.3.1 General policies**

15.3.1.1 All claims submitted to government departments shall be settled in consultation with the Finance/Justice Division/Department except where otherwise provided.

15.3.1.2 If the Justice Division/Department considers that the Government is not liable or that liability is doubtful, the authorised officer from that department shall advise the instructing department of the legal position and the course of action proposed.

### **15.3.2 Claims against the Government for personal injury**

15.3.2.1 Where a claim for personal injury is made against the Government and the Government's liability is clear, the Justice Division/Department may recommend to the Department of Finance, an advance amount be given to the concerned department.

15.3.2.2 The amount shall be the one which the Justice Division/Department is satisfied will not exceed damages ultimately payable to cover ambulance, hospital, medical and like expenses incurred by the plaintiff as a result of the accident, which is the subject of his/her claim.

15.3.2.3 Where court has awarded damages against the Government and the Justice Division/Department agrees with the court decision, the Accountant General, in such cases, shall be informed of the court decision by the Justice Division/Department. The Accountant General shall then update the liability record accordingly.

### **15.3.3 Settlement of claims**

15.3.3.1 When damages are awarded by a court, a claim for an advance of funds necessary to effect settlement shall be submitted to the Accountant General by the department/entity.

15.3.3.2 The claim submitted to the Accountant General shall follow the procedures as set out in section 4.5 of chapter 4 of this Manual.

15.3.3.3 The claim shall include relevant order from the court who awarded the damages against the Government.

15.3.3.4 The Accountant General shall make the payment in accordance with the procedures as set out in chapter 4 of this Manual.

15.3.3.5 These directions are to be applied to all common law claims against the Government including claims arising out of contracts, money

---

allegedly owing by the Government and claims for personal injury or property damage.

- 15.3.3.6 Where insurance cover has been taken by the concerned PAO (i.e. against whose department the damages was awarded by the court), the process for recovery of amount from the insurance company shall proceed immediately, in accordance with rules and guidelines issued by the MoF and the insurance company.

## 15.4 Accounting Policies

- 15.4.1.1 The costs of insurance premiums, where incurred, are to be treated as an expense from the Consolidated Fund and recognised upon issue of payment as set out in chapter 4 of this Manual.
- 15.4.1.2 Similarly, the cost of claims made successfully on the Government shall be treated as an expenditure item.
- 15.4.1.3 The costs of insurance premiums and claims paid shall be budgeted for in the financial year under an existing provision or from savings within the concerned department/entity.
- 15.4.1.4 Where the compensation paid to concerned party is reimbursed by the insurance company within the same financial year, the reimbursement shall be used to off-set the compensation paid to concerned party.
- 15.4.1.5 If insurance claims, by an insurer to the Government, are paid in another financial year, it should be recognised as Consolidated Fund revenue (i.e. other income) and not re-used by the insuring Ministry or Department.
- 15.4.1.6 Claims against the Government pending settlement by the courts shall be recorded as contingent liabilities (refer chapter 11 of this manual). These liabilities requires disclosure in the notes to the Annual Accounts.
- 15.4.1.7 Claims awarded by the courts and not yet paid as at the 30 June, shall be recorded as current liabilities in the Annual Accounts.

### 15.4.2 Accounting entries

- 15.4.2.1 The double entry in relation to insurance premium paid is as follow.

Dr	Insurance head account
Cr	Bank account

[to record insurance premium paid as an expense item]

- 15.4.2.2 The double entry in relation to compensation paid to concerned party is as follow.

Dr	Compensation account
Cr	Bank account



[to record damages/compensation paid to concerned party]

- 15.4.2.3 The double entry where the compensation paid to concerned party is reimbursed by the insurance company within the same financial year.

Dr	Bank account
Cr	Compensation account

[to record reimbursement received from the insurance company in the same financial year]

- 15.4.2.4 The double entry where the compensation paid to concerned party is reimbursed by the insurance company in another financial year.

Dr	Bank account
Cr	Other income account

[to record reimbursement received from the insurance company in another financial year]

# 16 General Accounting

---

## Table of Contents

<b>16.1</b>	<b>Introduction</b>	<b>16.3</b>
<b>16.2</b>	<b>Retention of Accounting Records</b>	<b>16.4</b>
16.2.1	Responsibility of accounts	16.4
16.2.2	Accounting records	16.4
16.2.3	Need to keep financial records	16.4
16.2.4	Media of storage	16.5
<b>16.3</b>	<b>Maintenance of Accounting Records</b>	<b>16.6</b>
16.3.1	General policies	16.6
16.3.2	Accounting records kept by the DAO/AG/AGPR	16.6
16.3.3	Accounting records kept by the DDO	16.7
<b>16.4</b>	<b>Use of Suspense Account</b>	<b>16.8</b>
16.4.1	General policies	16.8
16.4.2	Clearance of suspense accounts	16.8
16.4.3	Clearing accounts	16.8
<b>16.5</b>	<b>Control of Official Forms and Chequebooks</b>	<b>16.9</b>
16.5.1	Official forms and accounting records	16.9
16.5.2	Chequebooks	16.9

**16.1 Introduction**

16.1.1.1 This chapter covers policies in relation to retention and maintenance of accounting records, use of suspense accounts and control of official forms and chequebooks.

## 16.2 Retention of Accounting Records

### 16.2.1 Responsibility of accounts

16.2.1.1 The Audit and Accounts Order lays down that "... the Auditor-General shall be responsible for the keeping of the accounts of the Federation and of each Province".

### 16.2.2 Accounting records

16.2.2.1 The accounting records refers to books of account upon which transactions are recorded or any other document issued or used in the preparation and processing of the transactions.

16.2.2.2 The accounting records covers not only accounting records such as cash book, vouchers, authorities, schedules and computer records, but also consolidated reports and policy papers supporting and justifying financial transactions.

### 16.2.3 Need to keep financial records

16.2.3.1 All accounting records will be retained in their original form for at least a period of ten years. Also refer to the Manual of Standing Orders for retention of permanent records such as Establishment Records, Pension Records etc.

16.2.3.2 Departments / entities may retain records longer than prescribed period and should determine the period themselves based on the following considerations, their administrative needs and the cost of storage. Departments / entities should keep their retention practices under review.

16.2.3.3 Considerations that apply to the retention period of particular records are:

- **Statutory requirements** - Various statutes prescribe minimum retention periods for certain classes of records. Departments/entities should consult MoF or the Accountant General if they need guidance on the statutory requirements applicable to the various records they hold.
- **Administrative needs** - Departments will need to consider whether records that do not need to be preserved permanently should be retained for administrative purposes longer than the minimum time required and by any relevant statutory requirement. Internal Audit Officer and other consultancy, inspection and review services may also make use of such records in the course of their reviews and should therefore be consulted about their requirements.

Longer retention may be necessary to enable departments to handle late claims, settle disputes or for the satisfactory conduct of departmental business including departments own and their internal auditors' need to monitor past decisions and actions.

- **Requirements of external audit** - Records supporting transactions including vouchers, schedules and other authorities will be retained until the completion of the audit although the Auditor-General Office may be prepared to consider special arrangements where there are major storage problems. The Auditor-General's Office normally expect departments / entities to retain main records for ten years. The timetable for the destruction of main ledgers and of records supporting transactions is in the Manual of Standing Orders.

#### **16.2.4 Media of storage**

16.2.4.1 The Auditor-General's Office requires to see the original documents when conducting audits. Originals of documents such as contracts, agreements, guarantees and titles to property may be required for other purposes, including presentation as evidence to the Courts.

16.2.4.2 Departments/entities should consult the MoF or the Accountant General if they have doubts about the need for records that have to be retained in their original form.

16.2.4.3 Where records are kept for administrative purposes which do not have to be kept in their original form, departments/entities may wish to consider the costs and benefits of transferring them on to micro-film or converting them into computer data or other electronic formats so that originals may be destroyed.

## **16.3 Maintenance of Accounting Records**

### **16.3.1 General policies**

16.3.1.1 The following policies shall be applicable to all accounting records:

- accounting records are not to be maintained in loose-leaf form
- in the preparation and processing of transactions, and in all accounting and related entries, pencil is not to be used
- erasures (including the use of correction fluids or chemicals) are not permitted in any accounting record
- under no circumstances are pages to be removed from an accounting record
- where corrections are necessary the word or figure to be removed shall be ruled through and the correction initialled by the officer making it. The correct entry will then be inserted above the correction
- in a manual system, where corrections are made in the Sub Ledger / General Ledger effecting the double entry transaction, any amendment shall be carried out through a journal entry
- where corrections are necessary in a computerised accounting system, the original entry shall be reversed and the correct entry shall be made through a journal entry.

### **16.3.2 Accounting records kept by the DAO/AG/AGPR**

16.3.2.1 The accounting records (manual or computerised) which need to be kept by the DAO/AG/AGPR include the following:

- monthly accounts
- sub-ledger
- General Ledger
- budget head register
- claim register
- certification and authorisation register
- cheque register
- various abstracts
- physical assets account
- liability register
- bank reconciliation statement

- all permanent records (e.g. establishment records, GP fund ledgers)
- subsidiary registers (e.g. contingent register, receipts register)
- supporting vouchers and schedules.

### **16.3.3 Accounting records kept by the DDO**

16.3.3.1 The accounting records (manual or computerised) which need to be kept by the Drawing and Disbursing Officer include the following:

- cash book (or equivalent)
- petty cash book (or equivalent)
- contingent payment register
- commitment register
- payroll/establishment register
- receipt register
- financial asset register
- budget head register.

16.3.3.2 In addition to above primary accounting records, the DDO may also maintain such other records as are necessary to manage its own resources. Refer to chapter 9 of this Manual for such records, which may be maintained by self-accounting entities.



## **16.4 Use of Suspense Account**

### **16.4.1 General policies**

16.4.1.1 Suspense and other clearing accounts will only be used in the following situations:

- if there are insufficient details at the time of transaction, to indicate the appropriate head to be debited or credited, then the amount should be taken to the appropriate suspense head
- if there is doubt as to whether the General Ledger are properly due to or from the Government then the suspense head should also be used

16.4.1.2 Suspense accounts shall not be used for transactions relating to contingent expenditures. Such expenditures shall only be certified and authorised if the correct budget head is mentioned on the claim voucher, as set out in chapter 4 of this Manual.

### **16.4.2 Clearance of suspense accounts**

16.4.2.1 Where a suspense account is used, the delegated officer in the DAO/AG/AGPR shall identify the correct transaction head to be used and clear the above suspense account on a monthly basis.

16.4.2.2 The Accountant General is responsible to make sure that suspense accounts are cleared on a monthly basis and any outstanding item is investigated.

### **16.4.3 Clearing accounts**

16.4.3.1 Clearing accounts are special purpose accounts which are part of the double entry system, such as cheque clearing account, inter-entity clearing account. They should not be used for suspense transactions.

## **16.5 Control of Official Forms and Chequebooks**

### **16.5.1 Official forms and accounting records**

16.5.1.1 Only those official forms and accounting records shall be used which are mentioned in this Manual and prescribed by the Auditor General from time to time.

16.5.1.2 Authorised official forms and accounting records shall be obtained only from the authorised government printing and stationery centres.

16.5.1.3 Official forms and accounting records, relevant to a chapter, can be found at the end of each chapter of this Manual.

16.5.1.4 The purchasing officer in the department / entity shall follow the policies and guidelines as set out in chapter 13 of this Manual in relation to procurement and should ensure that:

- requisitions are prepared on the relevant form
- the quantity ordered is not in excess of his/her requirements
- the officer shall check that stock is sufficient enough to meet the requirement of his/her department / entity
- all forms or records received should be recorded immediately in the Accountable Forms & Books Register (or equivalent).

### **16.5.2 Chequebooks**

16.5.2.1 Requisitions for chequebooks shall be directly placed, by the authorised officer, with the AG/AGPR. The exception to this is for the assignment account and defence's cheque books where the requisitions are directly placed with the branch of the NBP / SBP where the cheque account is maintained.

16.5.2.2 To obtain the initial supply of chequebook, the requisition form supplied by the bank must be completed and submitted to the relevant bank branch.

16.5.2.3 For subsequent chequebook supplies, the special requisition form inserted in the chequebook should be completed and forwarded to the branch.

16.5.2.4 Chequebooks will be forwarded directly to the authorised officer by the bank and any queries relating to the non-arrival of supplies, etc., should be directed to the branch of the bank where the account is maintained.

16.5.2.5 Chequebooks received should be recorded immediately in the Cheque Register and kept in a secure place. Every time a cheque book is finished, it should also be noted in the cheque register.

# **17 Assignment Accounts and Personal Ledger Accounts**

---

## Table of Contents

<b>17.1</b>	<b>Introduction</b>	<b>17.3</b>
<b>17.2</b>	<b>Policies</b>	<b>17.4</b>
17.2.1	Assignment Accounts	17.4
17.2.2	Personal Ledger Accounts	17.4
17.2.3	General Policies	17.4
17.2.4	Accounting Policies	17.5
<b>17.3</b>	<b>Detailed Procedures</b>	<b>17.6</b>
17.3.1	Introduction	17.6
17.3.2	Establishment of new assignment account	17.7
17.3.3	Establishment of PLA	17.8
17.3.4	Processing of payments	17.8
17.3.5	Recording of expenditure	17.9
17.3.6	Year-end controls and adjustments	17.10
17.3.7	Closure	17.10
17.3.8	Reconciliation	17.10
17.3.9	Reporting	17.11
<b>17.4</b>	<b>Appendix A - Assignment Account/Personal Ledger Account Transactions</b>	<b>17.12</b>

## 17.1 Introduction

17.1.1.1 This chapter addresses the accounting policies and procedures for assignment accounts and personal ledger accounts operated by the Government, and should be read in conjunction with Chapters 4 and 10 of this Manual, 'Expenditures' and 'Project Accounting'.

17.1.1.2 Although there are some procedural differences between assignment account/personal ledger account transactions and other expenditure transactions, a consistent basis of accounting must be applied to all forms of expenditure. The modified cash basis of accounting is adopted, in accordance with the Manual of Accounting Principles.

17.1.1.3 There are personal ledger accounts and assignment accounts within the Government of Pakistan. There are two types of assignment accounts as follows:

- assignment accounts used by SAE's
- assignment accounts (also known as special imprest accounts) that are used for development projects.

17.1.1.4 Within this chapter the term assignment account refers to the latter.

17.1.1.5 Notwithstanding the above, the MoF in consultation with the Auditor General can authorise exceptions.

## **17.2 Policies**

### **17.2.1 Assignment Accounts**

- 17.2.1.1 An assignment account is a separate bank account opened in favour of a delegated authority, into which funds are released for specified purposes. An assignment account may be drawn on by the delegated authority (located in a spending Division or Department) without the requirement for certification and authorisation by the DAO/AG/AGPR.
- 17.2.1.2 Each assignment account is established at designated branches of the NBP in fixed currency. In cases where a project or other activity receives both GoP funding and foreign donor funding, separate Rupee and \$US assignment accounts must be maintained.

### **17.2.2 Personal Ledger Accounts**

- 17.2.2.1 A personal ledger account (PLA) is also a facility provided to a delegated authority in a division/department to incur expenditure up to a prescribed limit, without the requirement for certification and authorisation by the DAO/AG/AGPR. However unlike an assignment account a PLA is not a bank account; it is a separate ledger account maintained by the DAO/treasury office, with the spending limit controlled by these offices, rather than the NBP.

### **17.2.3 General Policies**

- 17.2.3.1 Assignment accounts and PLA's shall only be established with the approval of MoF, in consultation AGPR/AG.
- 17.2.3.2 Because both assignment accounts and personal ledger accounts by-pass a significant number of key controls specified in Chapter 4 of this Manual, their establishment and use shall be strictly limited to those situations where prompt payment is a necessary requirement of the entity.
- 17.2.3.3 Each application for assignment account or PLA shall be considered on a case by case basis, although such accounts are typically established for development projects.
- 17.2.3.4 Where assignment account or PLA expenditure is incurred from the Consolidated Fund, its funding must be included in the Schedule of Authorised Expenditure for a given financial year. Consequently, the balance remaining in each assignment account at the end of each financial year must lapse (i.e. not carried forward to the next year).
-

17.2.3.5 Alternatively, where assignment account or PLA expenditure is incurred from the Public Account (i.e. trust fund or special deposit account), its funding shall be sanctioned by MoF or the trust-holders, as the case may be, in accordance with the Acts, Presidential orders and other regulations governing the use of those accounts.

17.2.3.6 All expenditures incurred using an assignment account or PLA must be classified according to the Chart of Accounts. (i.e. to the relevant object, function, fund and entity to which the transaction relates). The nature of expenditure, incurring entity or source of funding does not change, simply because it has been incurred under an assignment account or PLA facility.

17.2.3.7 Assignment accounts and PLA's must not be used for the collection and recording of receipts.

17.2.3.8 Assignment accounts will be included in the overall cash balance of the Government for the purposes of financial reporting and bank reconciliation.

#### **17.2.4 Accounting Policies**

17.2.4.1 Expenditure in relation to assignment accounts will be recognised in the accounts when cheques have been drawn by the cheque signatory (i.e. upon the issue of payment).

17.2.4.2 Expenditure in relation to PLA's will be recognised in the accounts when payment has been endorsed by the respective DAO/treasury office maintaining that account, prior to encashment.



## 17.3 Detailed Procedures

### 17.3.1 Introduction

17.3.1.1 This section describes the detailed procedures and associated controls for the operation of assignment accounts and PLA's, including the following stages of processing:

- establishment of assignment account or PLA
- release of funds
- processing of payments
- recording of expenditure
- cheque clearance procedure
- year end procedure
- reconciliation
- reporting.

17.3.1.2 The key controls to be observed in respect of assignment and personal ledger account transactions are:

- signing of cheques drawn on the account, by the authorised cheque signatory, and countersigned by an co-signatory from the responsible ministry or department
- funds control exercised on each payment, by the NBP in the case of assignment accounts and by the DAO / treasury in the case of PLA's
- endorsement of cheques drawn on PLA's, by the concerned DAO / treasury office
- reconciliation of assignment account and PLA monthly balances to the bank
- lapsing of available funds released into assignment accounts, at the end of the financial year.

### **17.3.2 Establishment of new assignment account**

17.3.2.1 Upon approval for the establishment of an assignment account, an allocation of funds to the account is made under the sanction of the responsible ministry or department. This allocation will be based on clearance by MoF, who along with other central agencies, control the overall resource allocation process (eg. Public Sector Development Program, loan arrangements negotiated by EAD). The allocation shall be communicated to the relevant AG/AGPR office.

17.3.2.2 The Accountant General shall then issue a letter of assignment (form 17A) to the relevant DAO/treasury office with an endorsed copy to the branch manager of the State Bank of Pakistan, within whose area the account is opened. The letter of assignment shall specify the following details of the account to be opened:

- account name
- the bank branch from which it shall operate
- authorised cheque signatory and specimen signature
- drawing limit of the account
- budget head to which the release of funds shall be made (in doing so specifying clearly whether it is a Federal or Provincial Government account)
- any other conditions for the operation of that account.

17.3.2.3 Upon receipt of the letter of assignment, the delegated officer in the DAO / treasury office shall arrange for the opening of the assignment account at the designated branch of the National Bank of Pakistan, in the name of the authorised cheque signatory. At the same time, this delegated officer shall update the Appropriation Register by the amount of funds released against the assignment account. Although the balance of this account is monitored by the NBP, it is still important to reflect this information (i.e. funds available) in the records of the Government, via the Appropriation Register.

17.3.2.4 The authorised cheque signatory for the assignment account shall then be supplied with an official chequebook by the DAO/treasury office, for the purpose of official withdrawals from the account.

### **17.3.3 Establishment of PLA**

17.3.3.1 When approval has been given for the establishment of a PLA, the AG/AGPR shall advise the relevant DAO/treasury to establish the PLA in its records. This advice will include the following details:

- name of account
- authorised cheque signatory and specimen signature
- drawing limit for the account
- budget head to which the release of funds shall be made (in doing so specifying clearly whether it is a Federal or Provincial Government account)
- any other conditions for the use of the account.

17.3.3.2 Each personal ledger account shall then be established as a separate budget head in the Appropriation Register by the relevant DAO / treasury office, for the purpose of controlling the balance of each account. Each PLA shall be maintained in a separate section of this register titled 'Personal Ledger Accounts' on a division/department-wise basis.

17.3.3.3 The DAO / treasury office shall then issue an official chequebook to the authorised cheque signatory, from which cheques may then be drawn.

### **17.3.4 Processing of payments**

17.3.4.1 For both assignment accounts and PLA's, cheques are able to be drawn by authorised signatories of those accounts, from the time chequebooks are received, or other time, as communicated by the DAO / treasury office.

17.3.4.2 Cheques shall only be drawn by the authorised cheque signatory where it is required for immediate disbursement or reimbursement of expenditures previously incurred.

17.3.4.3 All cheques drawn from assignment accounts and PLA's must be countersigned by a delegated authority in the responsible ministry or department.

17.3.4.4 All cheques drawn in respect of PLA's must be endorsed by a delegated officer in the DAO / treasury office prior to encashment. This delegated officer shall check the following before endorsing payment:

- sufficient funds exist within the nominated PLA, for the payment to be made (as indicated in the budget head in the Appropriation Register)
- the cheque has been drawn only by the authorised cheque signatory
- the cheque has been written in proper form, from an official chequebook

17.3.4.5 The above endorsement process of PLA's requires the relevant budget head to be provided to the DAO / treasury so that the Appropriation Register can be duly checked and updated. It also requires the cheque register to be updated, for those cheques endorsed.

### 17.3.5 Recording of expenditure

17.3.5.1 Because assignment account transactions do not pass through the certification and authorisation process, the expenditure cannot be recorded by the DAO/AG/AGPR upon the making of payment. The concerned DDO of the responsible ministry / department shall submit a copy of the schedule of payments, in the prescribed form, to the concerned DAO / treasury office on a daily basis (or as cheques are drawn depending on the volume). This schedule will also provide the expenditure coding details for each cheque drawn.

17.3.5.2 When this schedule of payments is received by the DAO / treasury office, the expenditure transaction shall be recorded in the Sub-Ledger / General Ledger of that office. The appropriate journal entry in this case will be:

Dr	Detailed expenditure head
Cr	Bank account

17.3.5.3 In the case of PLA's the expenditure shall be recorded in the accounts when endorsement has been given for the cheque at the DAO / treasury office. The accounting entry will be the same as that provided in the above Direction.

17.3.5.4 The Appropriation Register shall be updated against the relevant budget heads when assignment account and PLA expenditures are recorded (i.e. reduce available funds).

17.3.5.5 It should be noted that a separate cheque clearing account shall be maintained for each assignment account as a means of matching

recorded expenditures to the bank scroll details of cheques actually cashed.

### **17.3.6 Year-end controls and adjustments**

- 17.3.6.1 No cheques are permitted to be drawn from assignment accounts or PLA's after 30 June, against the Schedule of Authorised Expenditure from the previous financial year. Any commitments established under those assignment accounts or PLA's shall be duly reversed in accordance with Chapter 4 of this Manual 'Expenditures'.
- 17.3.6.2 Where assignment accounts or PLA's relate to Public Account expenditures, it is not necessary to close those accounts at year end, subject to any other conditions associated with the use of those monies.
- 17.3.6.3 Where the balance in the assignment account or PLA lapses at the end of the financial year, the Appropriation Register balance (i.e. funds available) against the relevant budget heads shall be reset to zero and closed, until funds are released for the following year. No entry is required to the Sub-Ledger / General Ledger, as only those cheques drawn will have been recorded as expenditure in the accounts during the year, and therefore no reversal is required.
- 17.3.6.4 Any amounts left outstanding in the cheque clearing account as at 30 June represent those cheques drawn before the end of the year but not yet cashed at the bank. Sufficient funds shall be retained in the respective assignment account / PLA to ensure these cheques are cleared.
- 17.3.6.5 The late drawing of cheques at year end does not represent good financial management practice, and is subject to directives issued by the Accountant General to avoid it.

### **17.3.7 Closure**

- 17.3.7.1 Assignment accounts and PLA's must be promptly closed when the relevant activity for which they were established has completed or has been otherwise wound up.

### **17.3.8 Reconciliation**

- 17.3.8.1 On a monthly basis the NBP shall send a bank scroll to the AG/AGPR for the bank account that it maintains.

17.3.8.2 Using the information contained in the bank statement the AG/AGPR shall prepare a reconciliation statement of the reported assignment account expenditures to the bank balance. The reconciliation shall consist of:

- opening assignment account balance as per bank statement
- *less* reported expenditures for the month by DAO/treasury
- *less* payments in bank statement but not advised by DDO
- *plus* uncleared cheques
- *equals* closing assignment account balance per bank statement.

17.3.8.3 Any unreported payments by the DDO identified in this reconciliation shall be verified with them, and appropriate adjusting entries made to bring the accounting records up to date, and reconciled to the bank statement.

17.3.8.4 In the case of PLA's, the transactions will be included in the bank statement received for the relevant Food/Non-Food bank account by the AG/AGPR. Therefore the bank reconciliation for PLA's will be included in the general bank reconciliation procedures provided in Chapter 6 of this Manual.

### **17.3.9 Reporting**

17.3.9.1 To provide a consolidated summary of assignment account and PLA balances used in the bank reconciliation described above, each DAO / treasury office shall submit details of assignment account and PLA balances to their relevant AG/AGPR at the end of each month.

17.3.9.2 On a quarterly, basis ministries and departments shall submit a detailed Statement of Expenditure for all assignment accounts and PLA's under their control, to the respective AG/AGPR offices. These reports will assist in verification of the accounting records made and further details on these expenditures should further audit analysis be required.

---

**17.4 Appendix A - Assignment Account/Personal Ledger Account Transactions**

Event	General Ledger Entries	Appropriation Register
Approve Annual Budget	Nil	Update funds available by budgeted amount
Release funds	Nil	Update appropriation control by amount released
Endorse cheque (PLA) or Received DDO schedule (assignment account)	Dr expenditure head Cr bank account	Reduce funds available by cheque amount Reduce appropriation control by cheque amount
Year end adjustment for remaining balance of funds	Nil	Reduce funds available to 0 (zero)  Reduce appropriation control to balance off cheque clearing account